



US00D433739S

# United States Patent [19]

Lord

[11] **Patent Number: Des. 433,739**

[45] **Date of Patent: \*\* Nov. 14, 2000**

[54] **FAUCET HANDLE**

[75] Inventor: **Judd A. Lord**, Carmel, Ind.

[73] Assignee: **Masco Corporation of Indiana**, Indianapolis, Ind.

[\*\*] Term: **14 Years**

[21] Appl. No.: **29/117,792**

[22] Filed: **Jan. 31, 2000**

[51] **LOC (7) Cl.** ..... **23-01**

[52] **U.S. Cl.** ..... **D23/252; D23/250**

[58] **Field of Search** ..... **D23/238-257; D8/300-308, 350-354; 4/675-678; 137/801**

[56] **References Cited**

**U.S. PATENT DOCUMENTS**

D. 221,431	8/1971	Patterson	.....	D23/252
D. 291,590	8/1987	Bengtsson	.....	D23/238
D. 322,307	12/1991	Chretien	.....	D23/252
D. 324,412	3/1992	Bonnell	.....	D23/252
D. 339,852	9/1993	Jans	.....	D23/252

D. 409,289	5/1999	Hyde et al.	.....	D23/252
D. 413,654	9/1999	Paredes et al.	.....	D23/250

*Primary Examiner*—Louis S. Zarfaz  
*Assistant Examiner*—Gregory Andoll  
*Attorney, Agent, or Firm*—Myron B. Kapustij; Lloyd D. Doigan

[57] **CLAIM**

The ornamental design for a faucet handle, as shown and described.

**DESCRIPTION**

FIG. 1 is a front perspective view of the faucet handle showing my new design;  
FIG. 2 is a rear perspective view thereof;  
FIG. 3 is a left side elevational view thereof, the right side being a mirror image;  
FIG. 4 is a top plan view thereof;  
FIG. 5 is a front elevational view thereof;  
FIG. 6 is a rear elevational view thereof; and,  
FIG. 7 is a bottom plan view thereof.

**1 Claim, 2 Drawing Sheets**

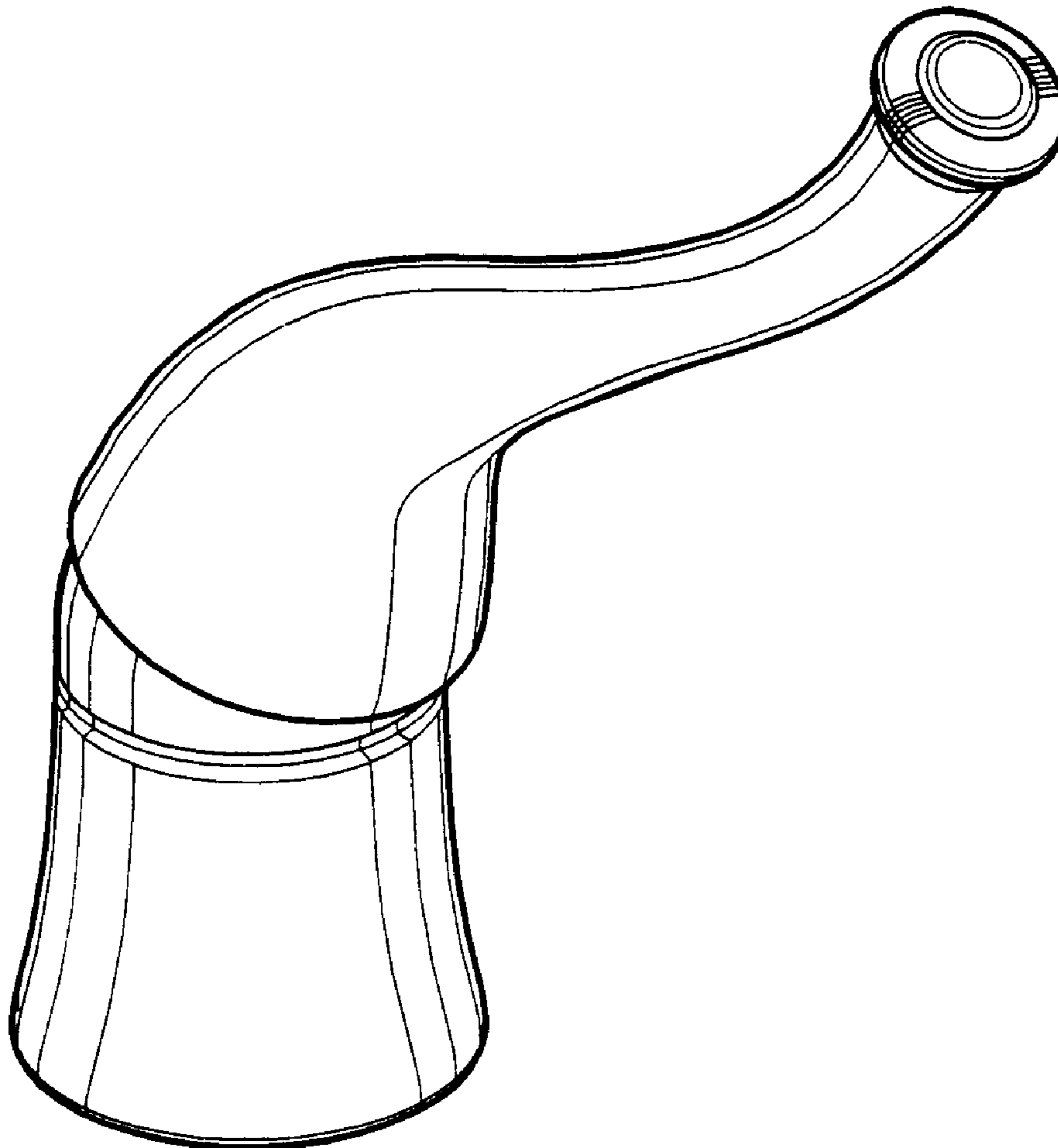

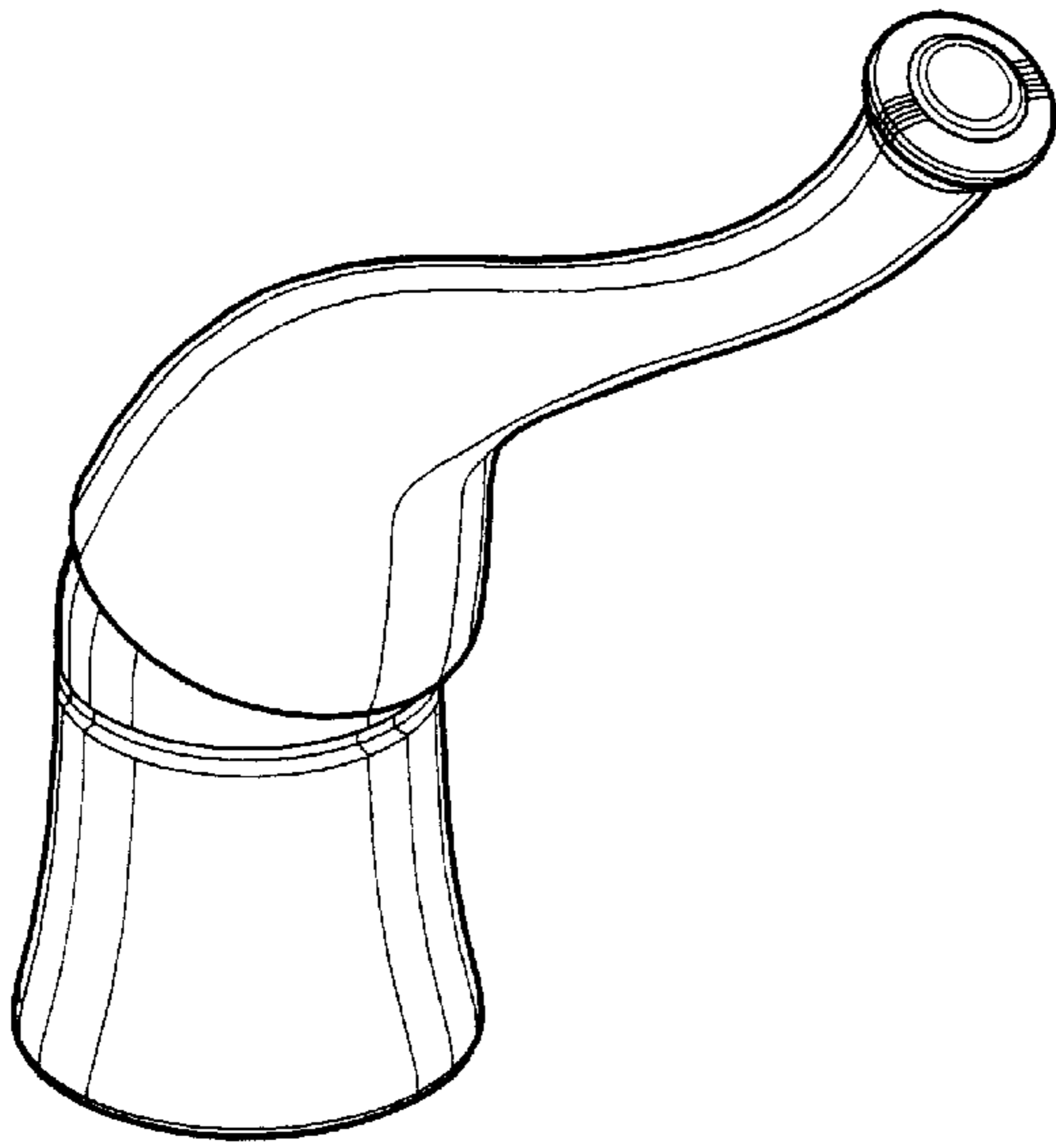

Fig-1

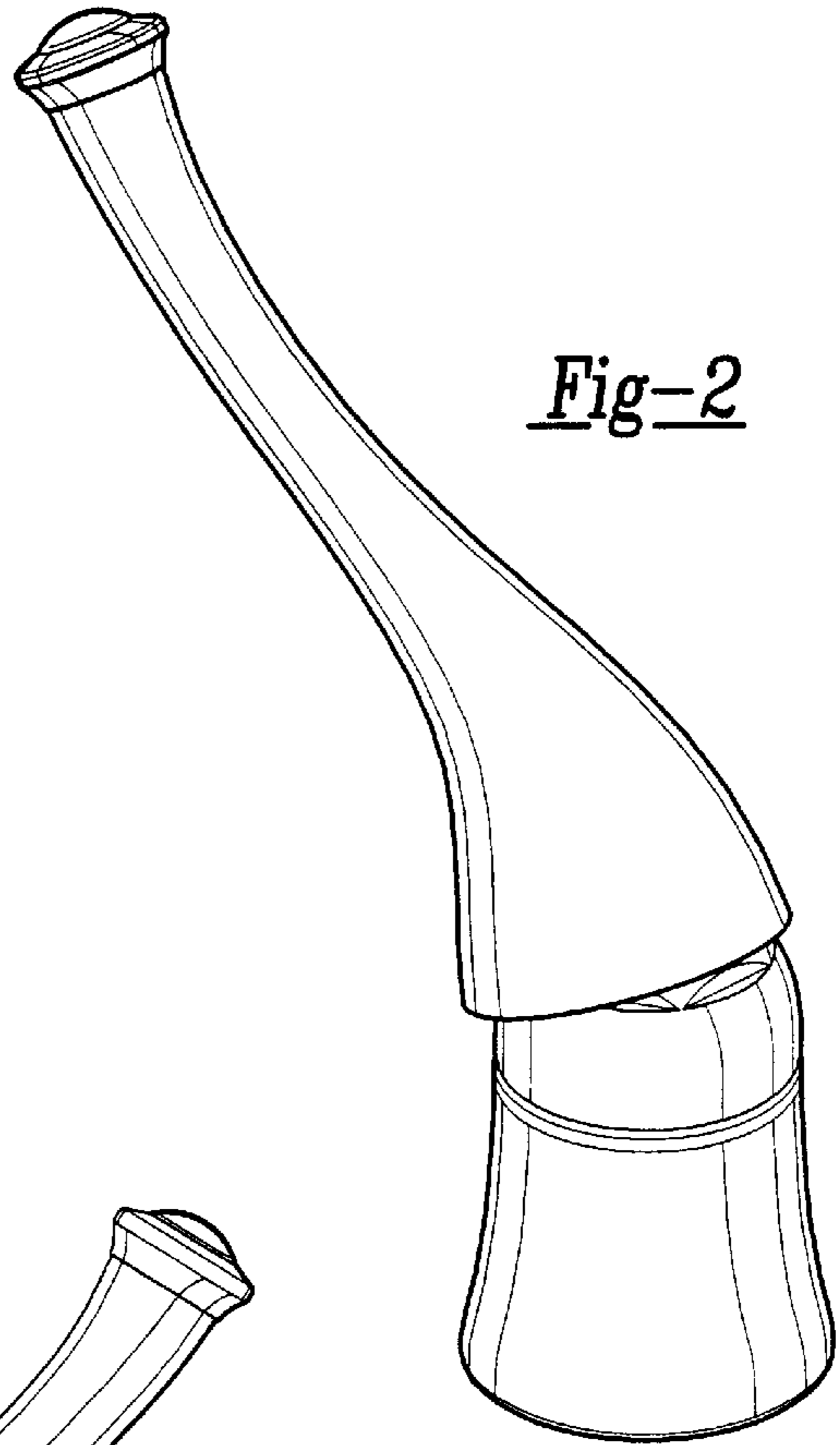

Fig-2

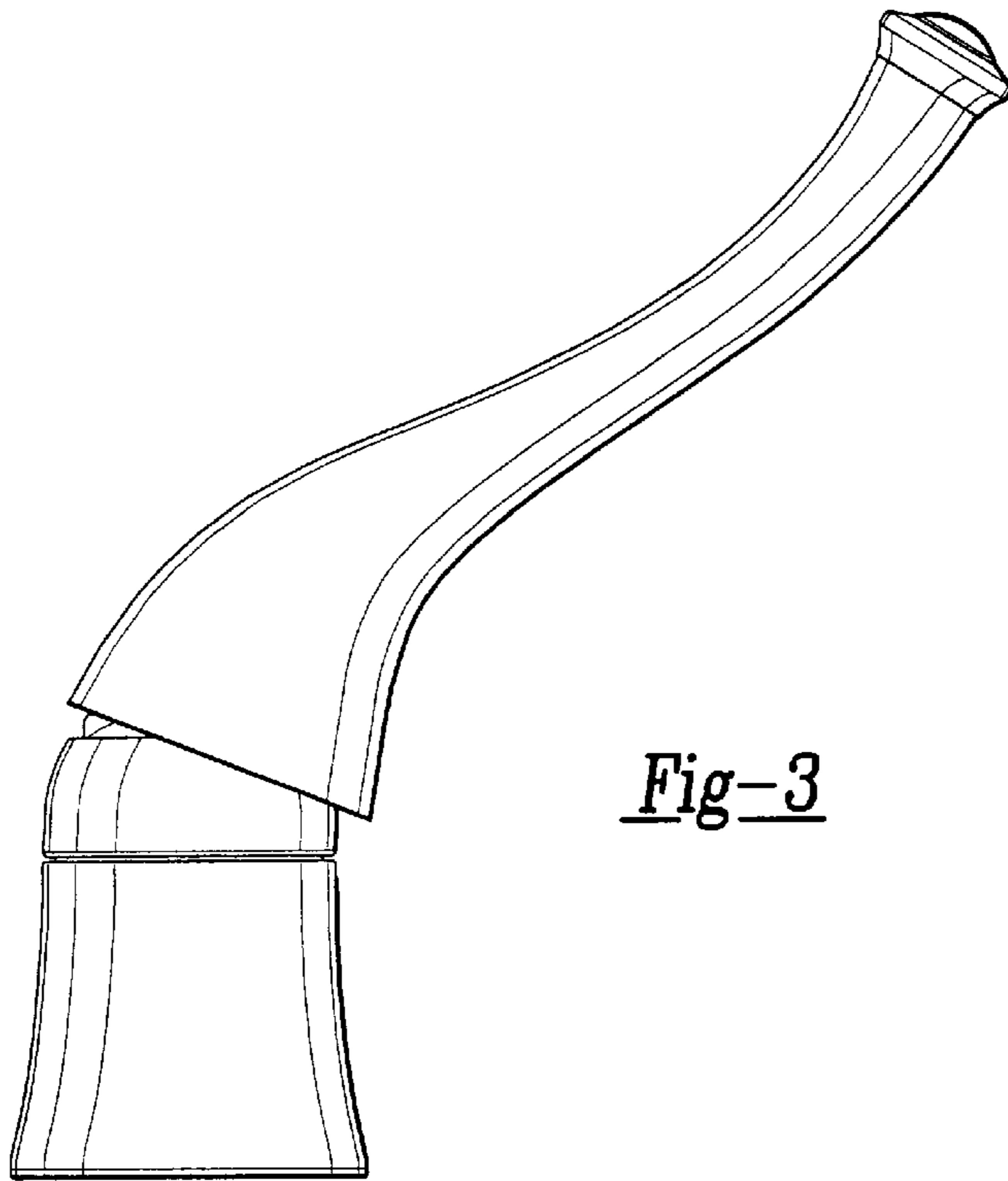

Fig-3

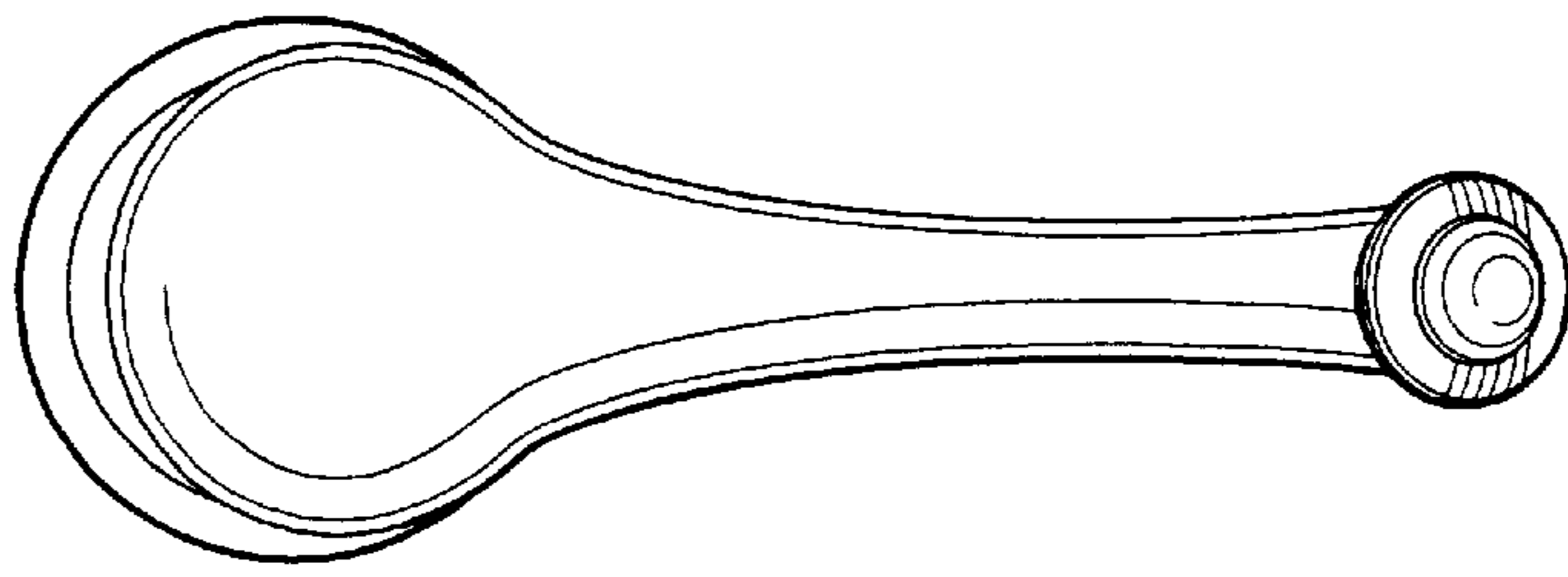

Fig-4

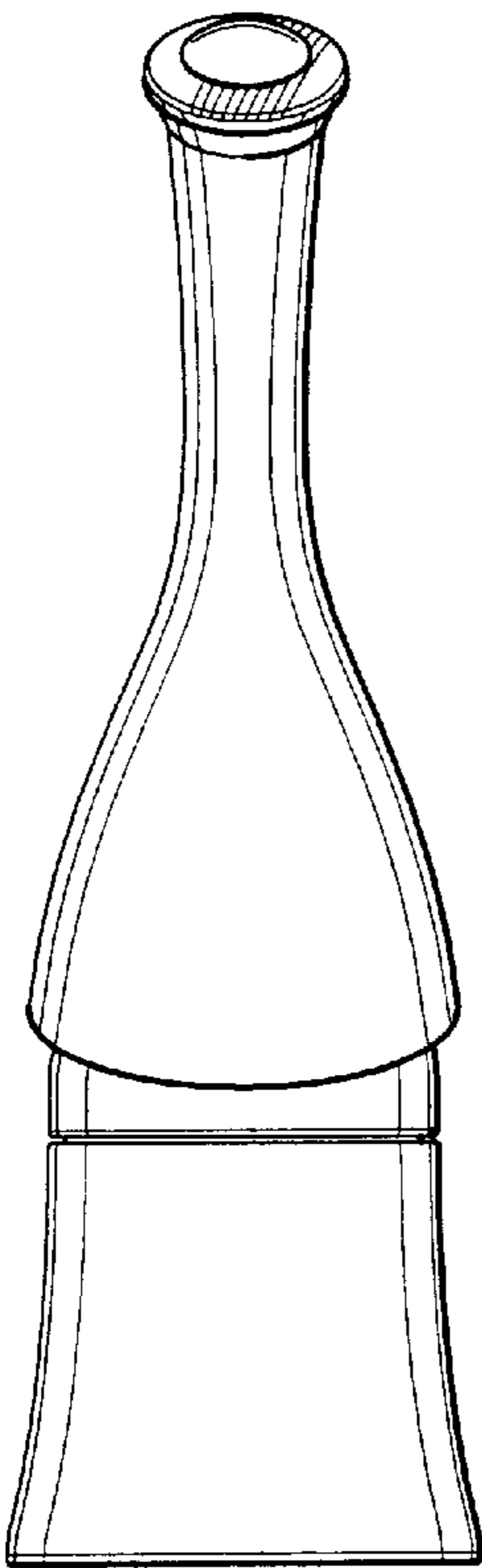

Fig-5

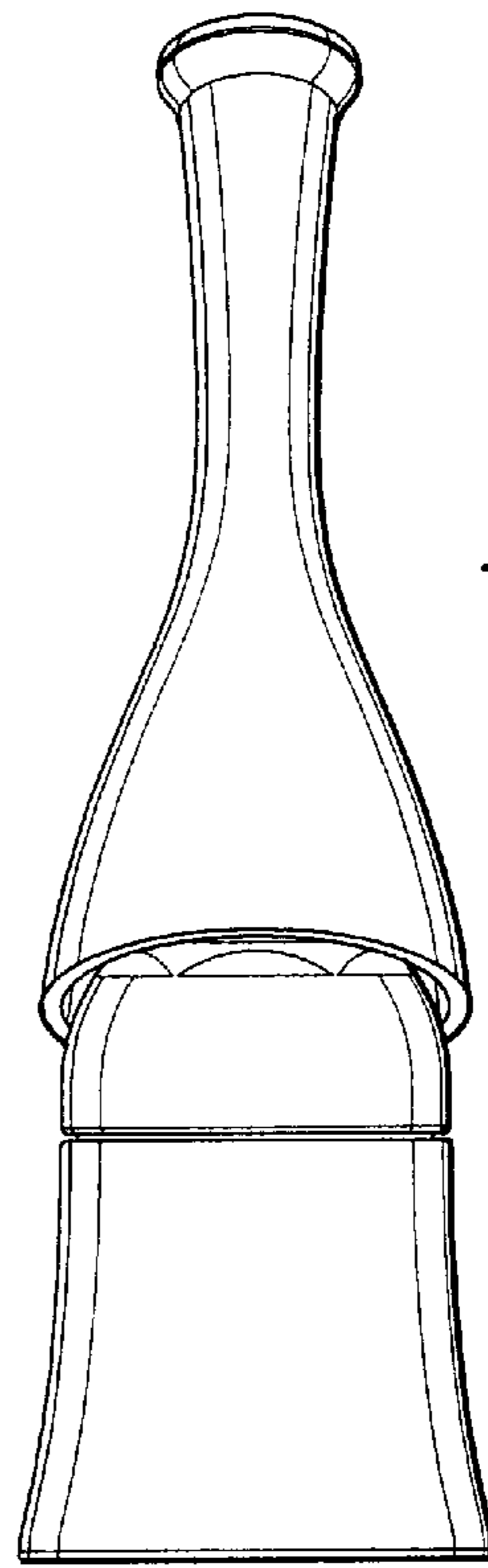

Fig-6

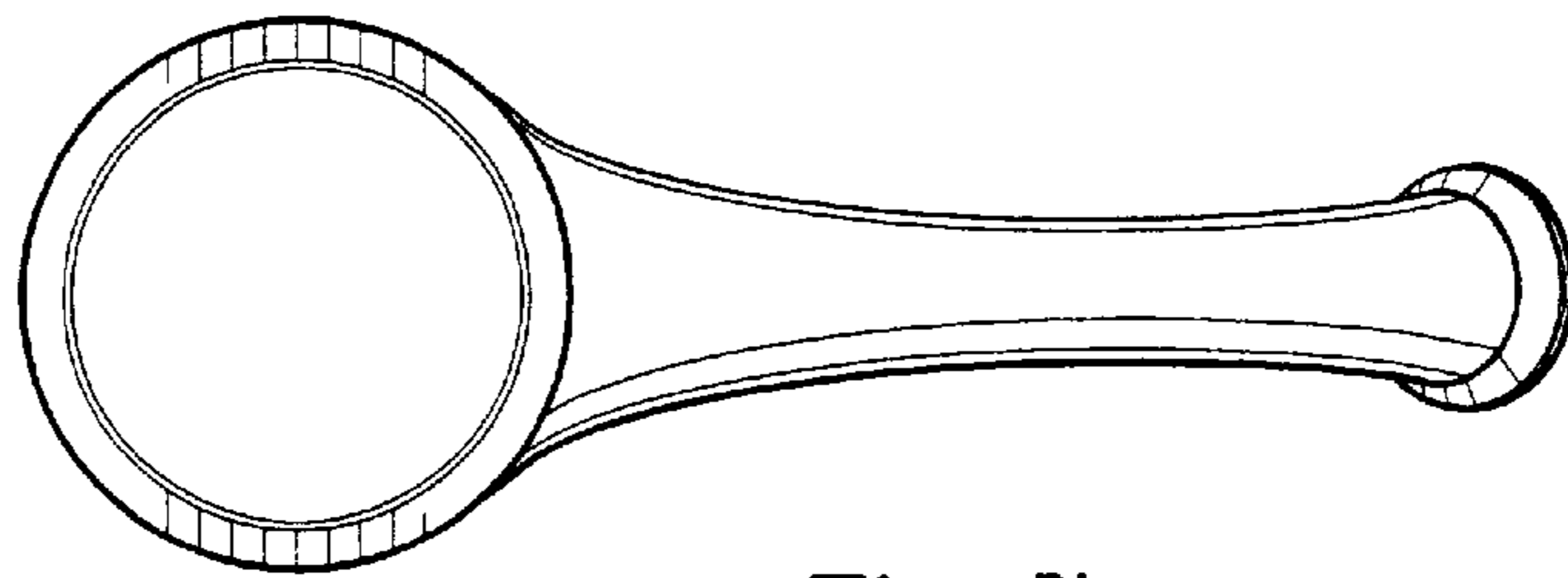

Fig-7