



US00D433734S

United States Patent [19] Spangler

[11] **Patent Number: Des. 433,734**

[45] **Date of Patent: ** Nov. 14, 2000**

[54] **FAUCET HANDLE**

[75] Inventor: **Anthony G. Spangler**, Greensburg, Ind.

[73] Assignee: **Masco Corporation of Indiana**, Indianapolis, Ind.

[**] Term: **14 Years**

[21] Appl. No.: **29/116,040**

[22] Filed: **Dec. 23, 1999**

[51] **LOC (7) Cl.** **23-01**

[52] **U.S. Cl.** **D23/252; D23/250**

[58] **Field of Search** **D23/238-257; D8/300-308, 350-354; 4/675-678; 137/801**

[56] **References Cited**

U.S. PATENT DOCUMENTS

D. 387,137	12/1997	Donahue	D23/252
D. 397,412	8/1998	Slothower	D23/250
D. 407,465	3/1999	Ko	D23/252
D. 416,312	11/1999	Kolada	D23/255
D. 422,342	4/2000	Mark et al.	D23/238

Primary Examiner—Louis S. Zarfes
Assistant Examiner—Gregory Andoll
Attorney, Agent, or Firm—Myron B. Kapustij; Lloyd D. Doigan

[57] **CLAIM**

The ornamental design for a faucet handle, as shown and described.

DESCRIPTION

FIG. 1 is a front perspective view of the faucet handle showing my new design;
FIG. 2 is a rear perspective view thereof;
FIG. 3 is a left side elevational view thereof, the right side being a mirror image of the left;
FIG. 4 is a front elevational view thereof;
FIG. 5 is a top plan view thereof;
FIG. 6 is a rear elevational view thereof; and,
FIG. 7 is a bottom plan view thereof.
The broken line showing of the inner wall in FIGS. 6 and 7 is for purposes of illustration only and forms no part of the claimed design.

1 Claim, 3 Drawing Sheets

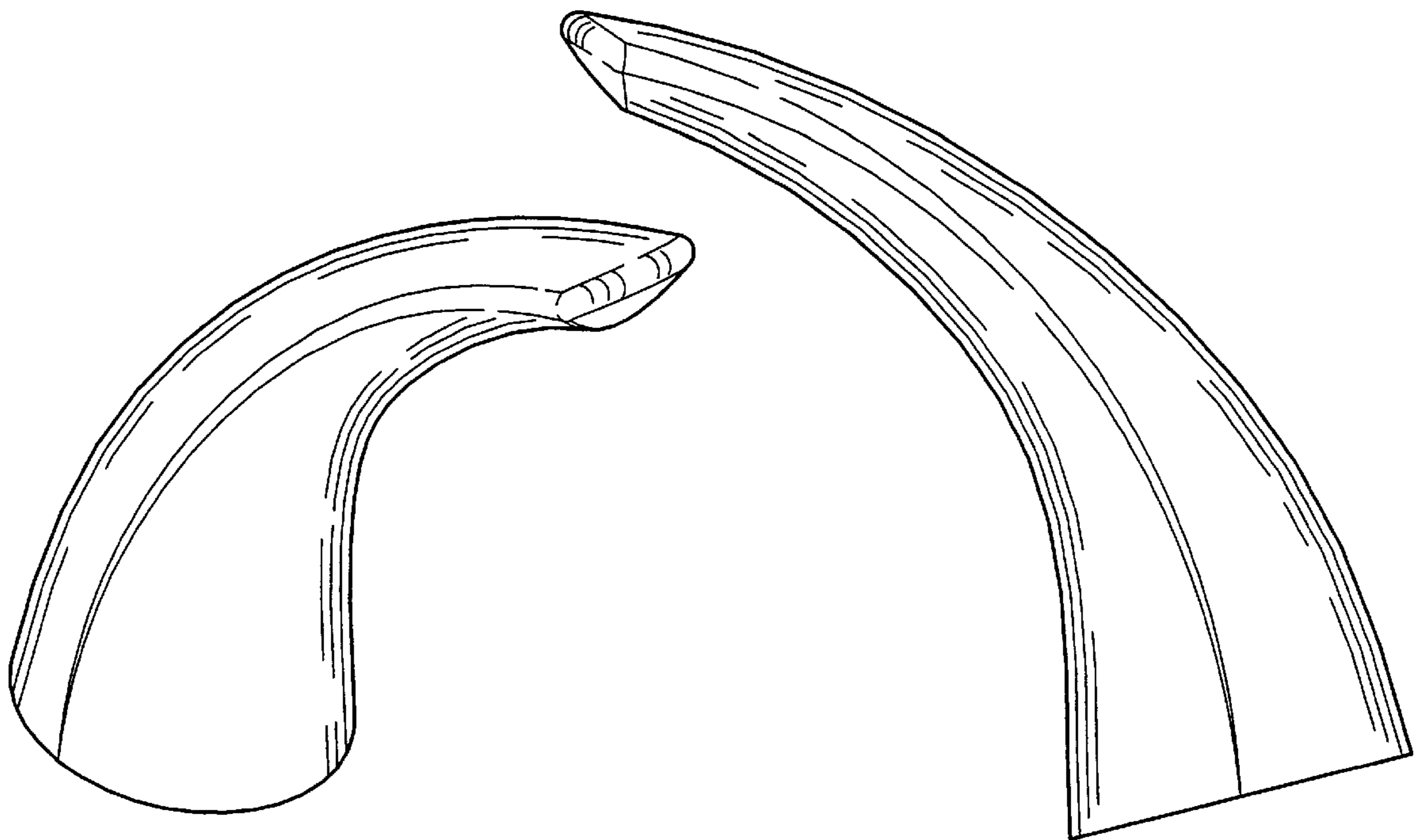

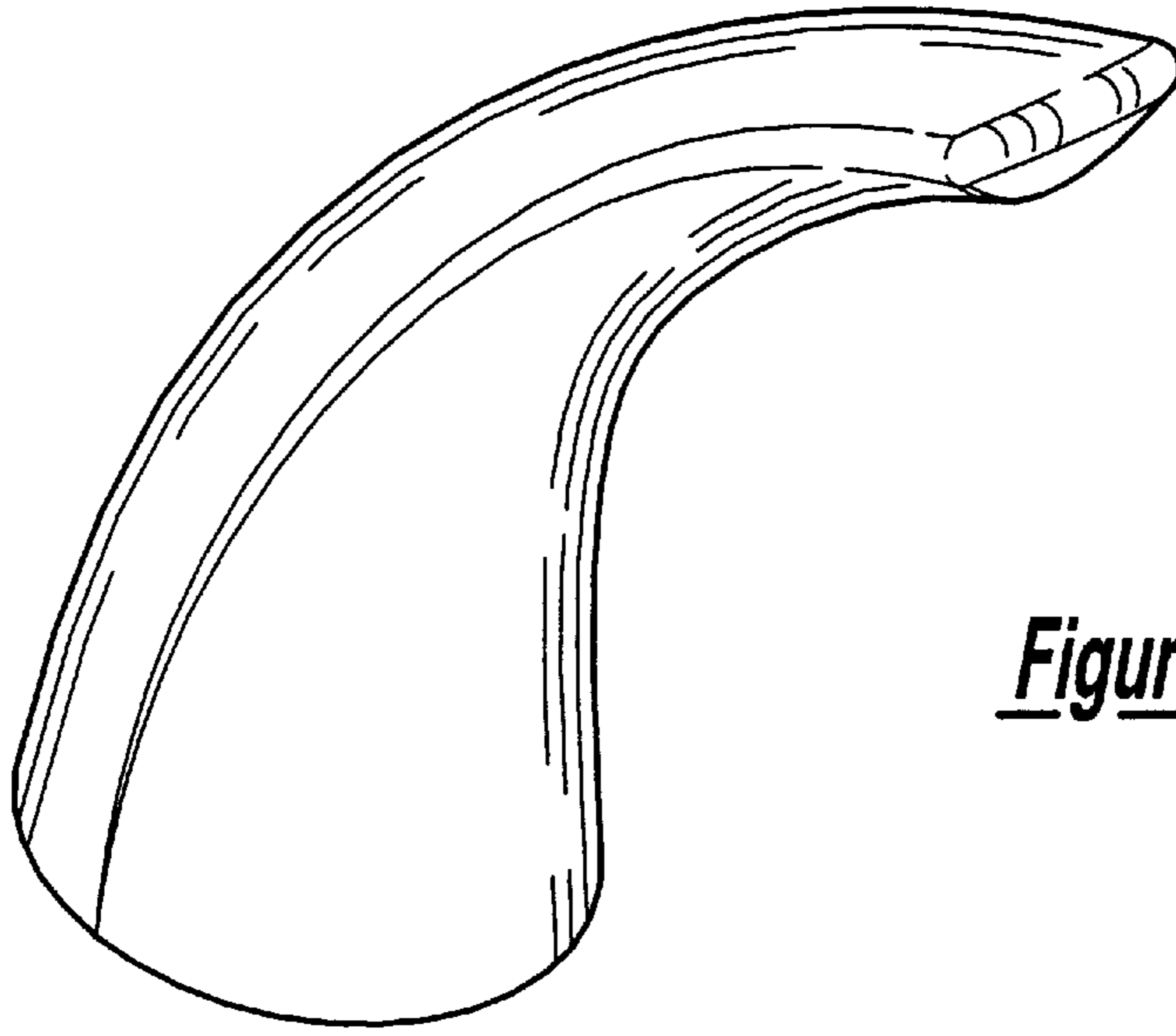

Figure - 1

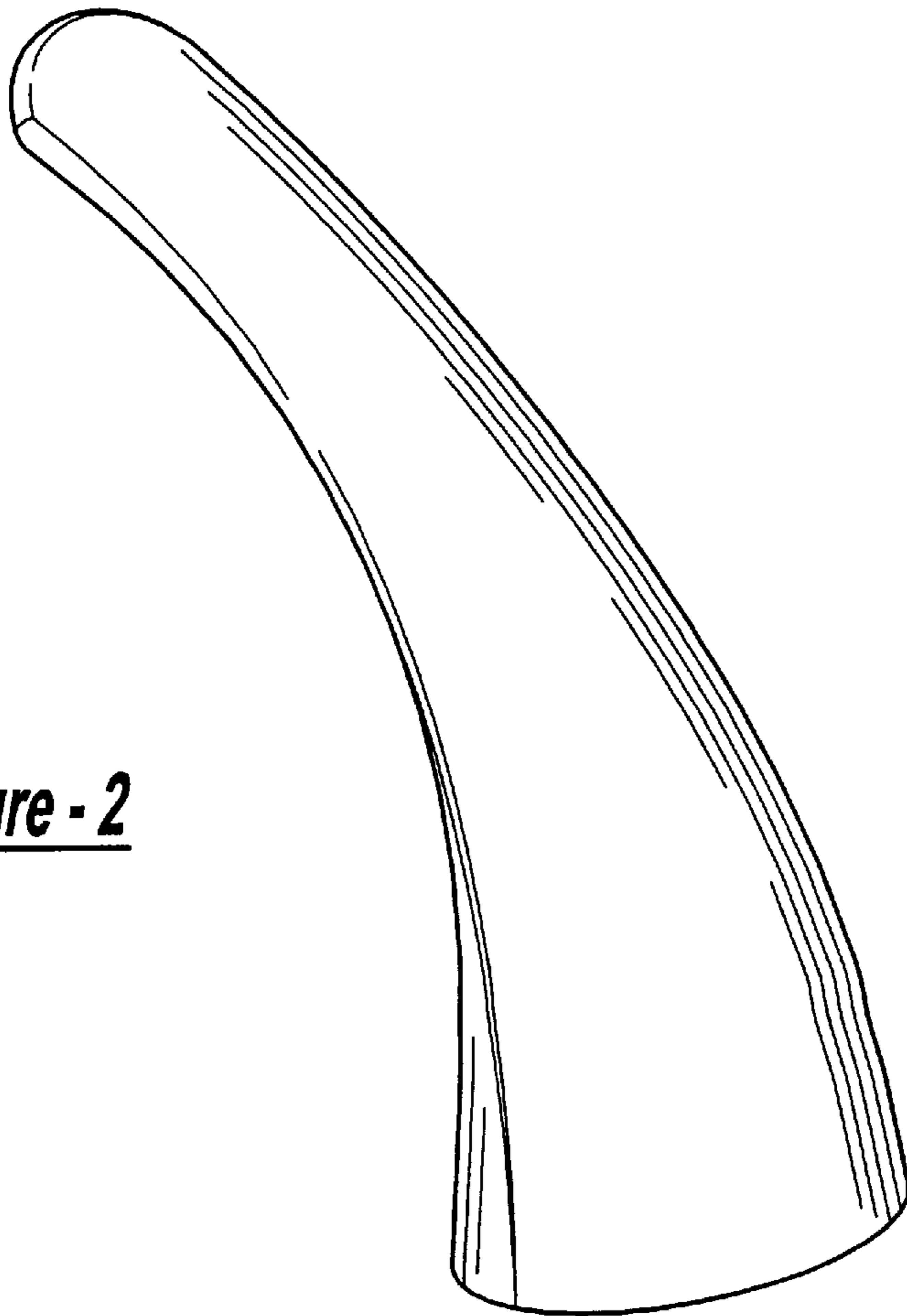

Figure - 2

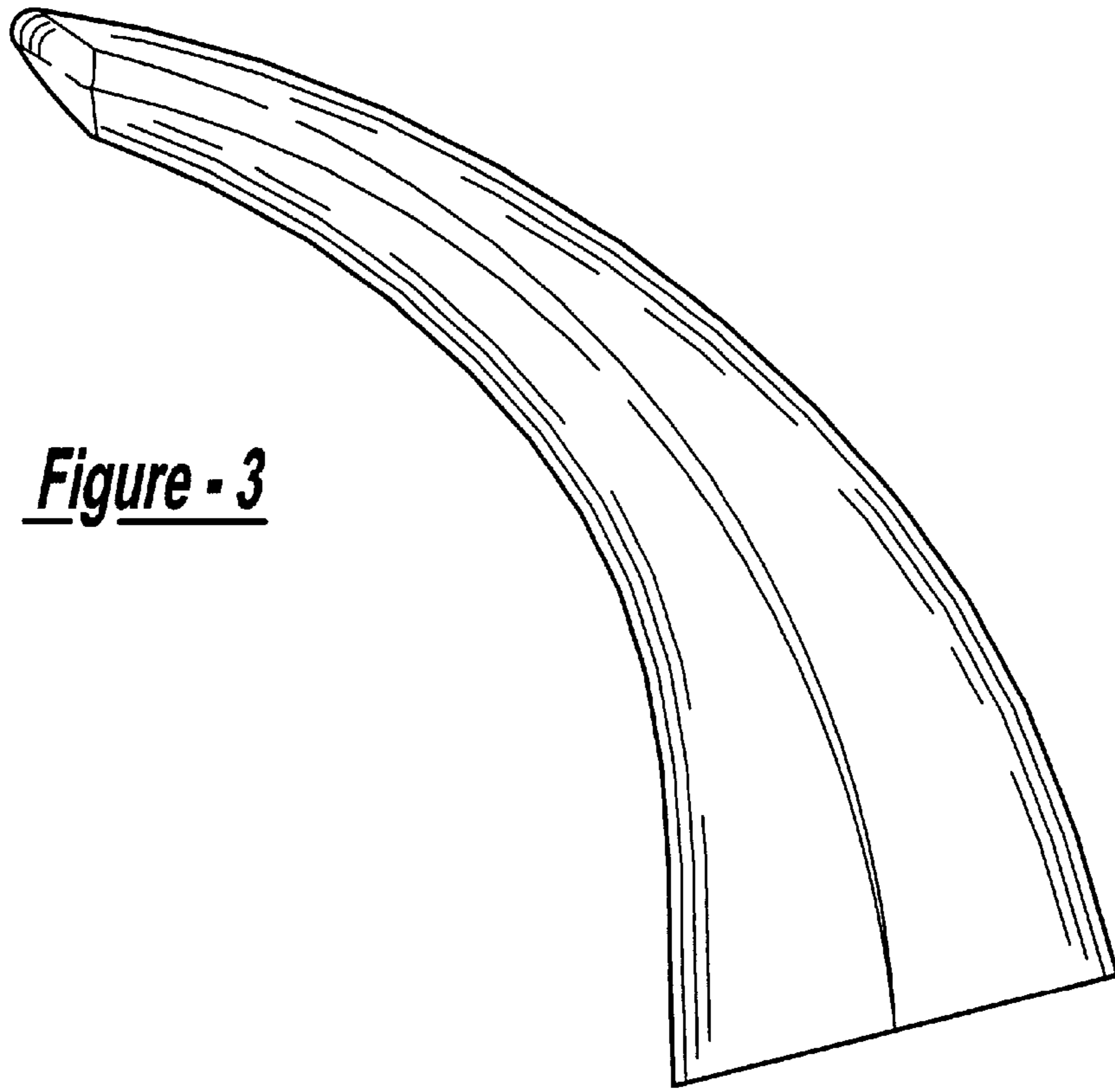

Figure - 3

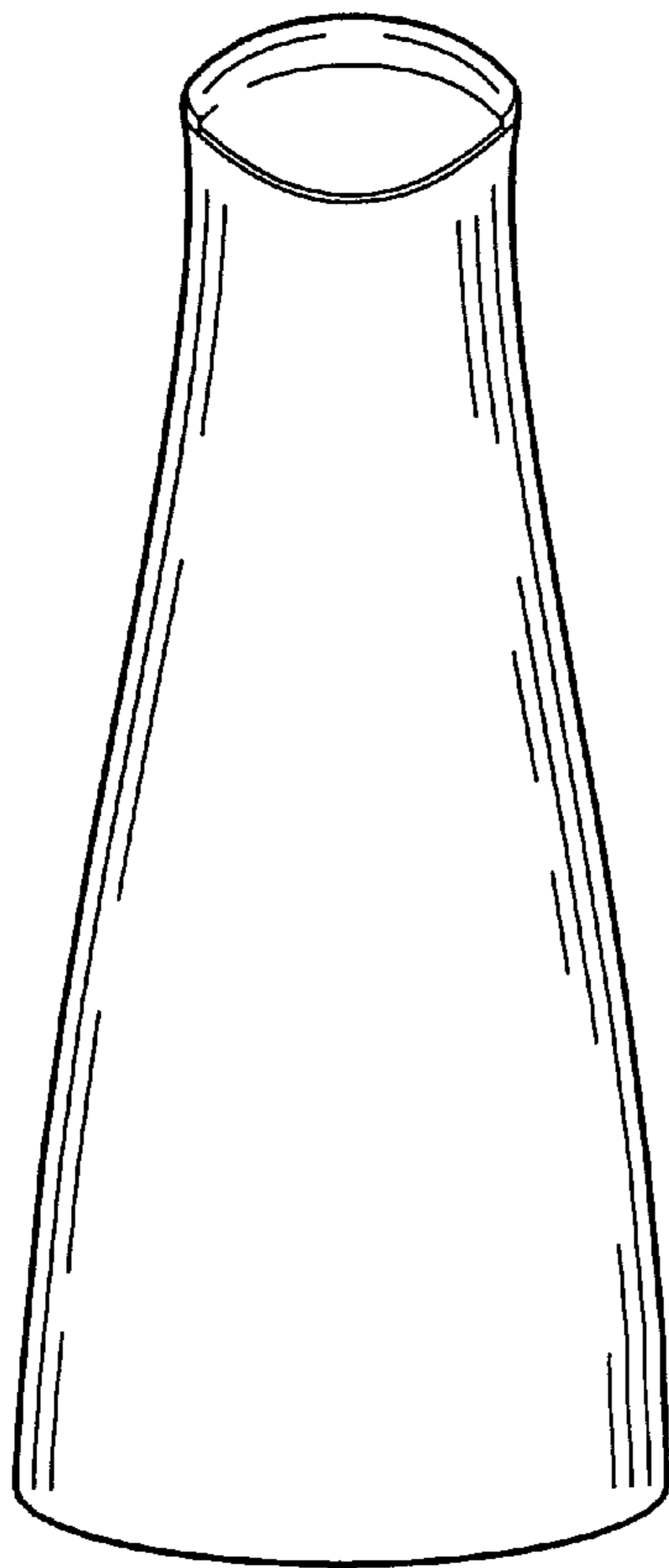

Figure - 4

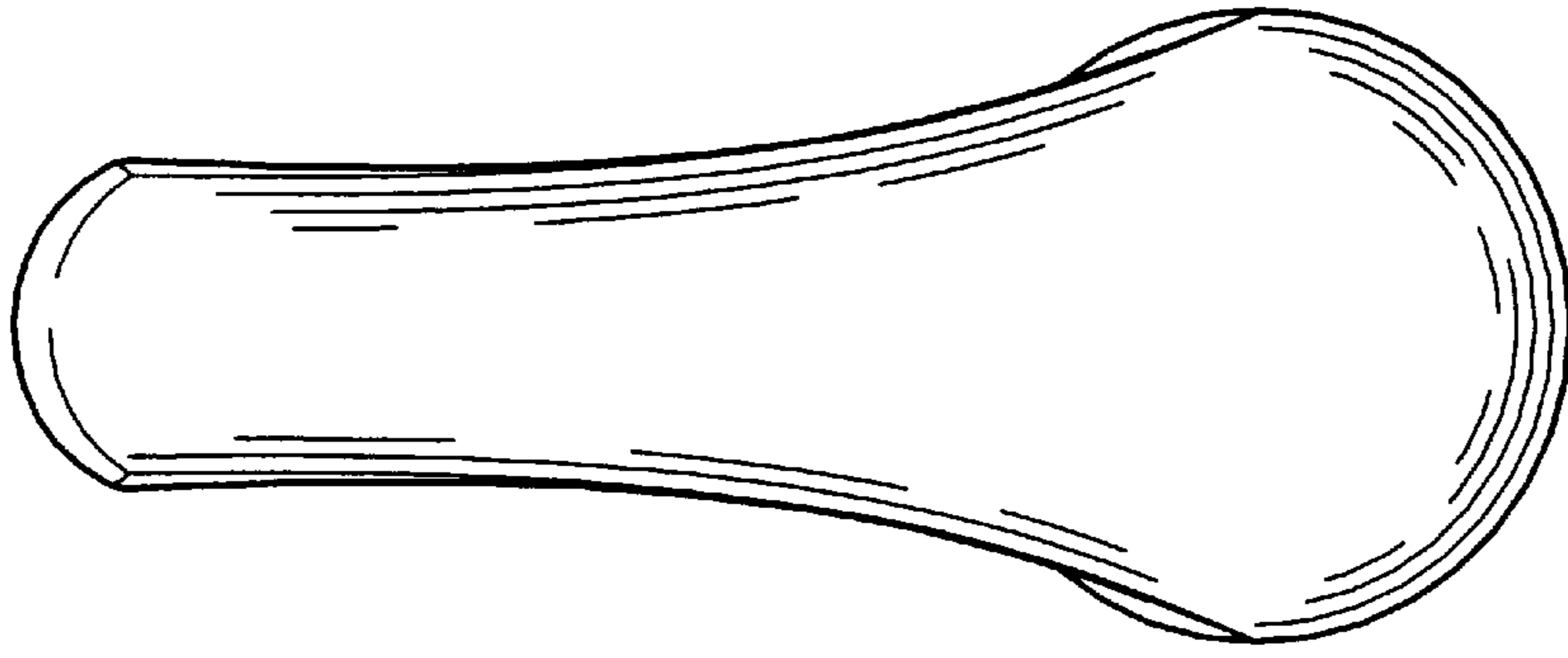

Figure - 5

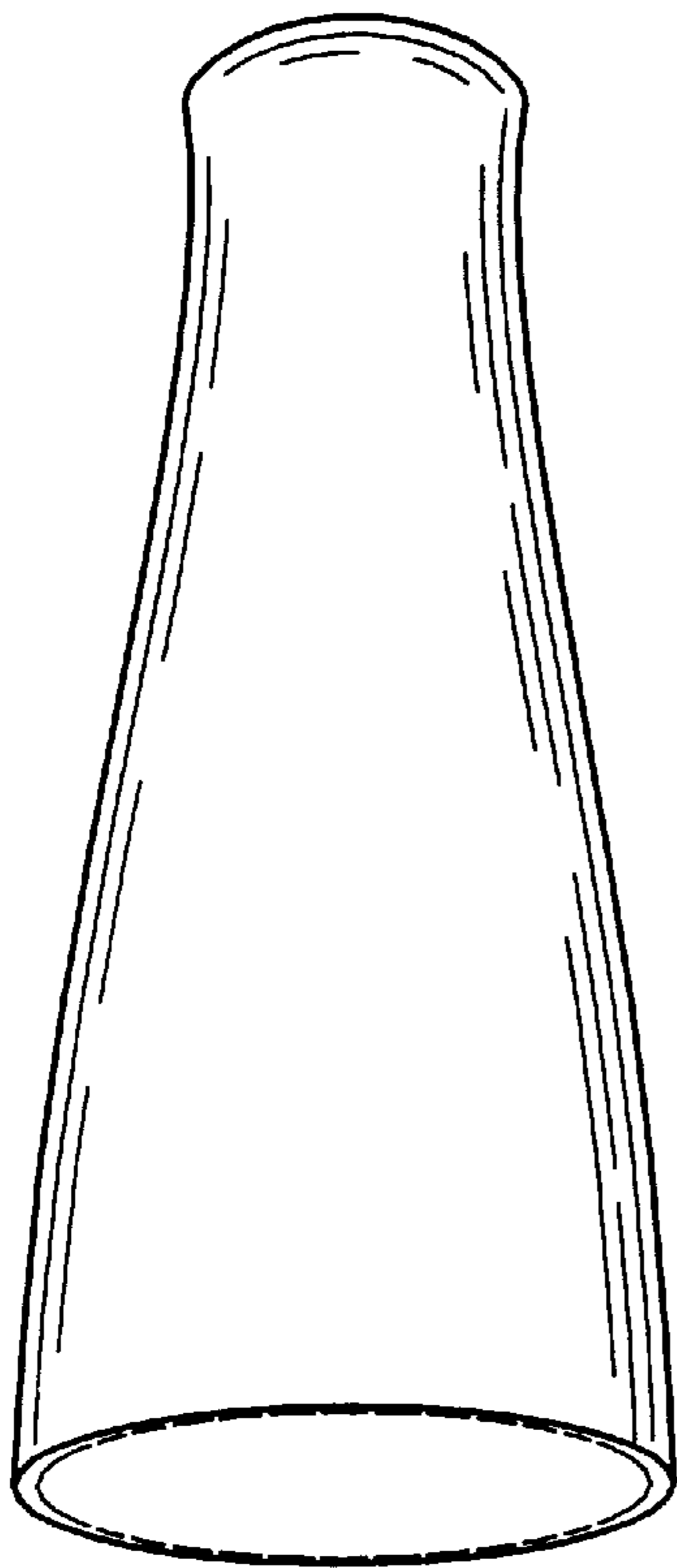

Figure - 6

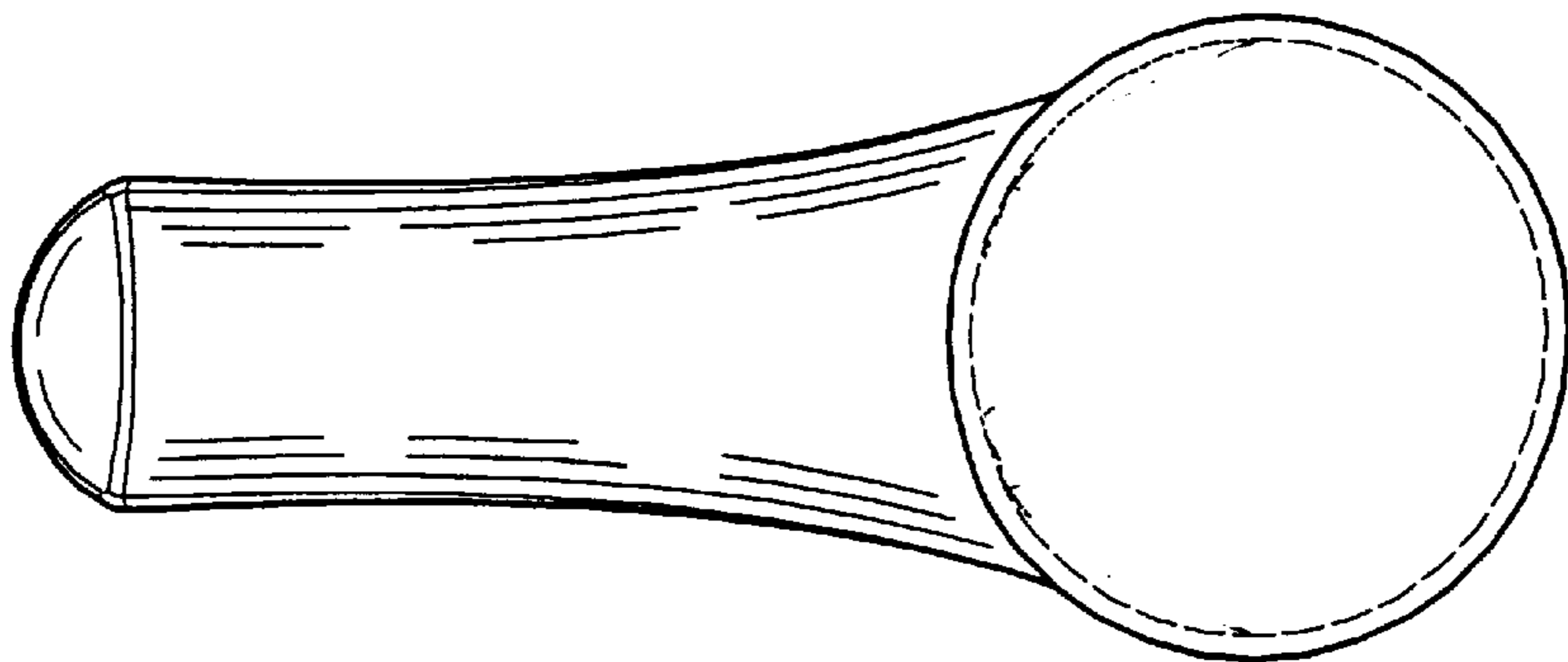

Figure - 7