



US00D433684S

# United States Patent [19]

Jean et al.

[11] Patent Number: Des. 433,684

[45] Date of Patent: \*\* Nov. 14, 2000

[54] COMPUTER FRONT BEZEL

D. 416,245 11/1999 Jean et al. .... D14/445  
5,116,261 5/1992 Lan et al. .... 312/292

[75] Inventors: Paul Jean, Taipei; Kaven Kan, Taipei; Ying Sheng Yeh, Taipei, all of Taiwan

Primary Examiner—Freda Nunn  
Attorney, Agent, or Firm—Wei Te Chung

[73] Assignee: Hon Hai Precision Ind. Co., Ltd., Taipei Hsien, Taiwan

[57] CLAIM

The ornamental design for a computer front bezel, as shown and described.

[\*\*] Term: 14 Years

### DESCRIPTION

[21] Appl. No.: 29/116,190

FIG. 1 is a perspective view of a computer front bezel showing our new design;  
FIG. 2 is a front elevational view thereof;  
FIG. 3 is a rear elevational view thereof;  
FIG. 4 is a left side elevational view thereof;  
FIG. 5 is a right side elevational view thereof;  
FIG. 6 is a top plan elevational view thereof;  
FIG. 7 is a bottom plan view thereof; and,  
FIG. 8 is a perspective view thereof showing the computer front bezel mounted to a computer case it being understood that the case and all design features of said case are shown in broken lines for illustrative purposes only and form no part of the claimed design.

[22] Filed: Dec. 28, 1999

[51] LOC (7) Cl. .... 14-02

[52] U.S. Cl. .... D14/444

[58] Field of Search ..... D14/441, 444, D14/445, 446; D13/162, 184, 199, 164, 177; 312/223.2, 292

### [56] References Cited

#### U.S. PATENT DOCUMENTS

- D. 410,456 6/1999 Fu ..... D14/444
- D. 410,641 6/1999 Fu ..... D14/444
- D. 410,642 6/1999 Fu ..... D14/444
- D. 416,010 11/1999 Jean et al. .... D14/445

1 Claim, 6 Drawing Sheets

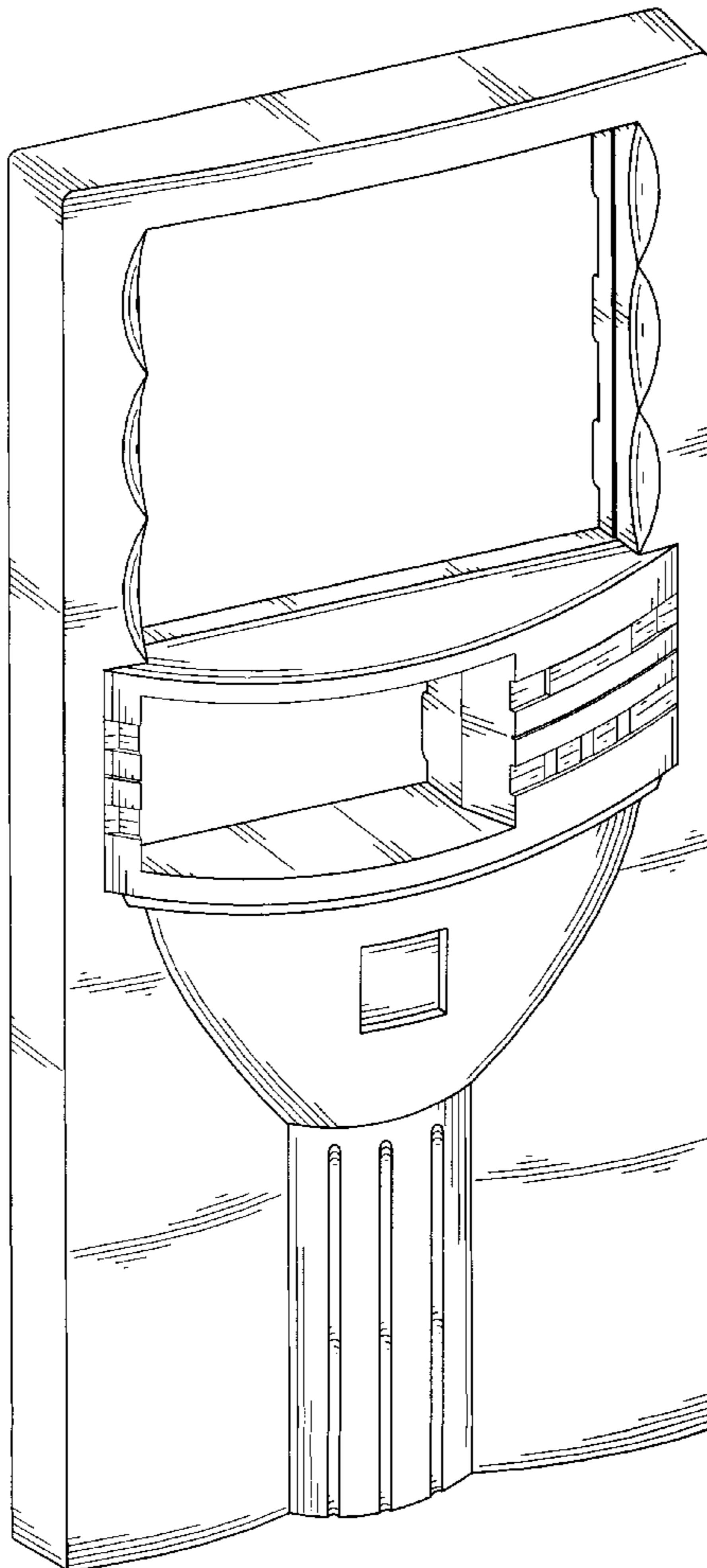

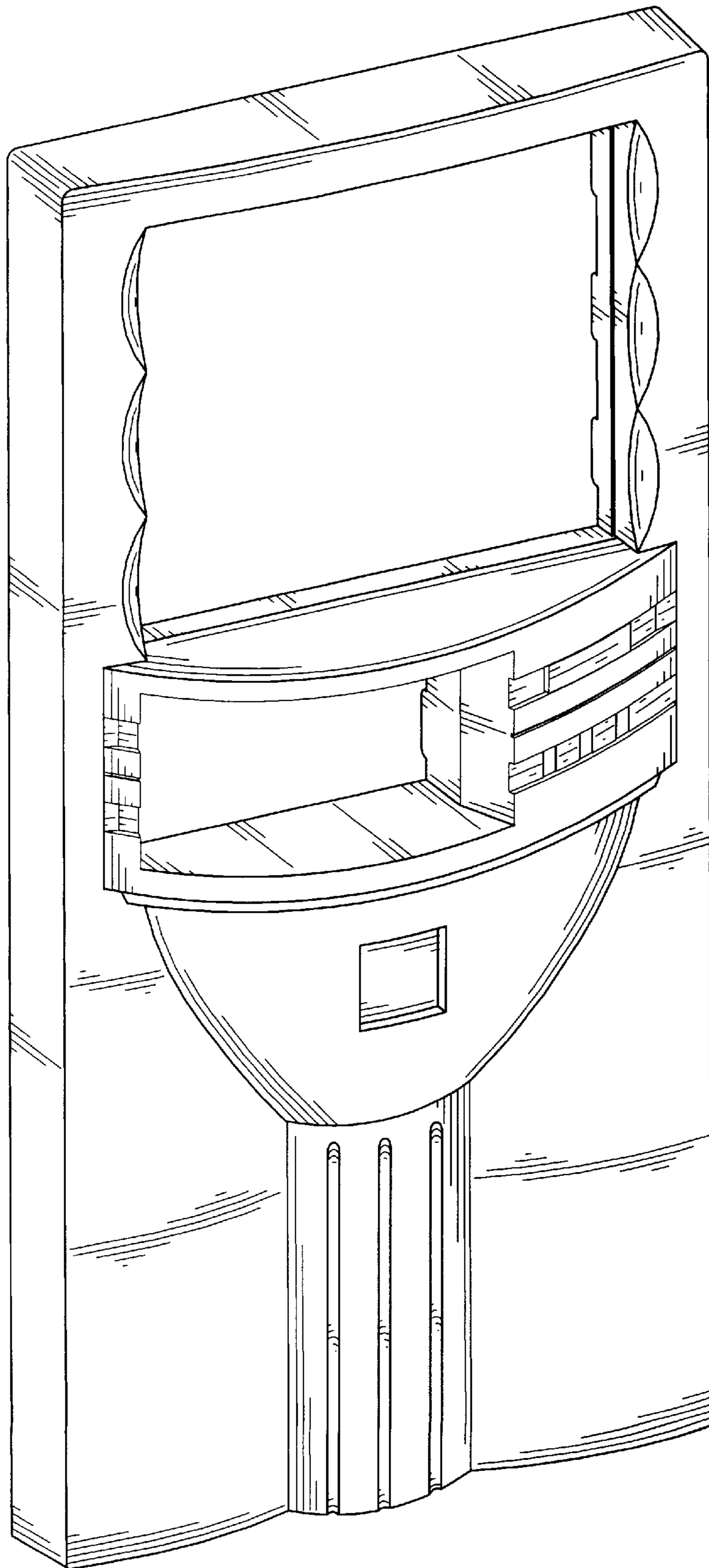

FIG. 1

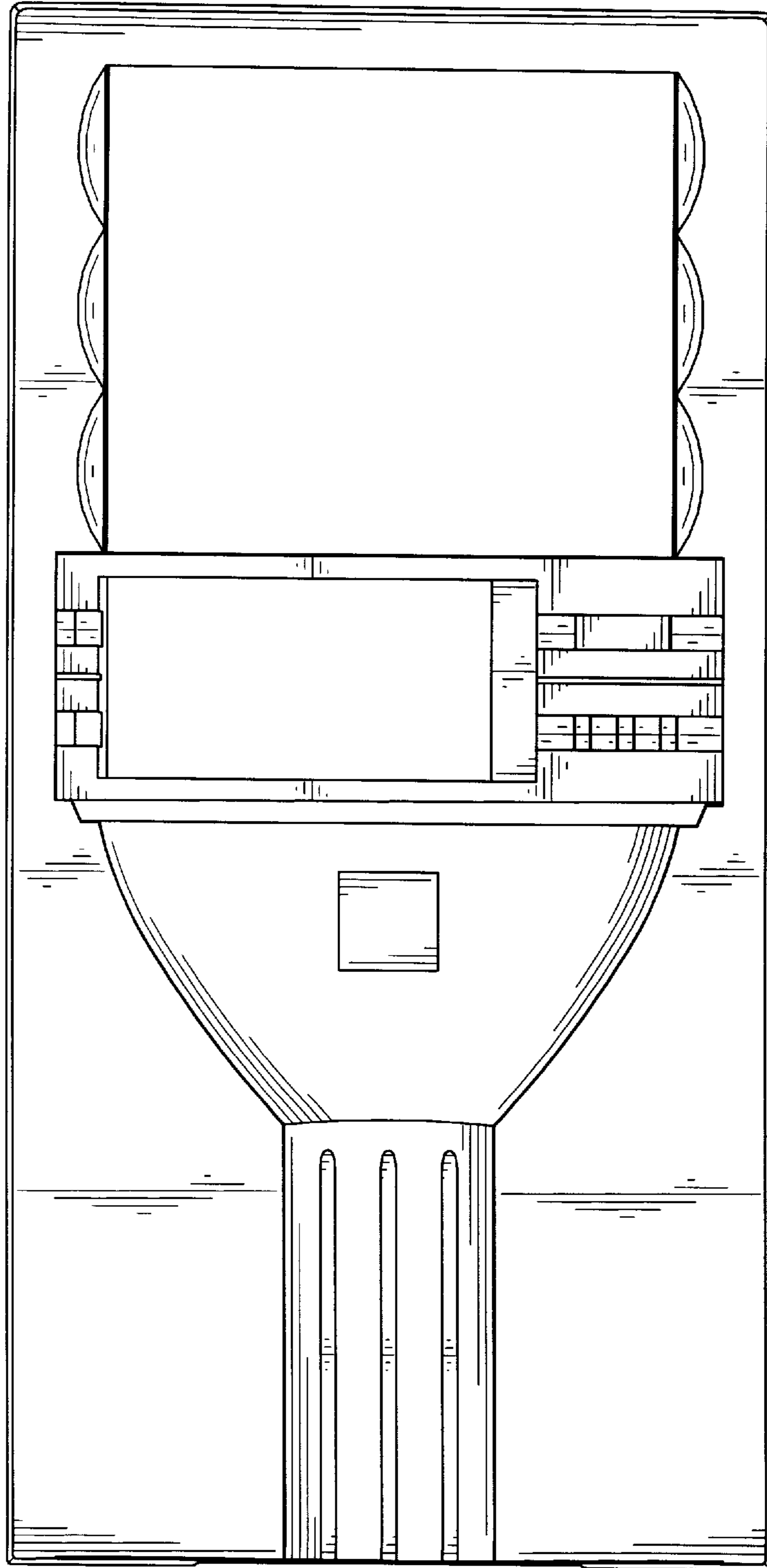

FIG. 2

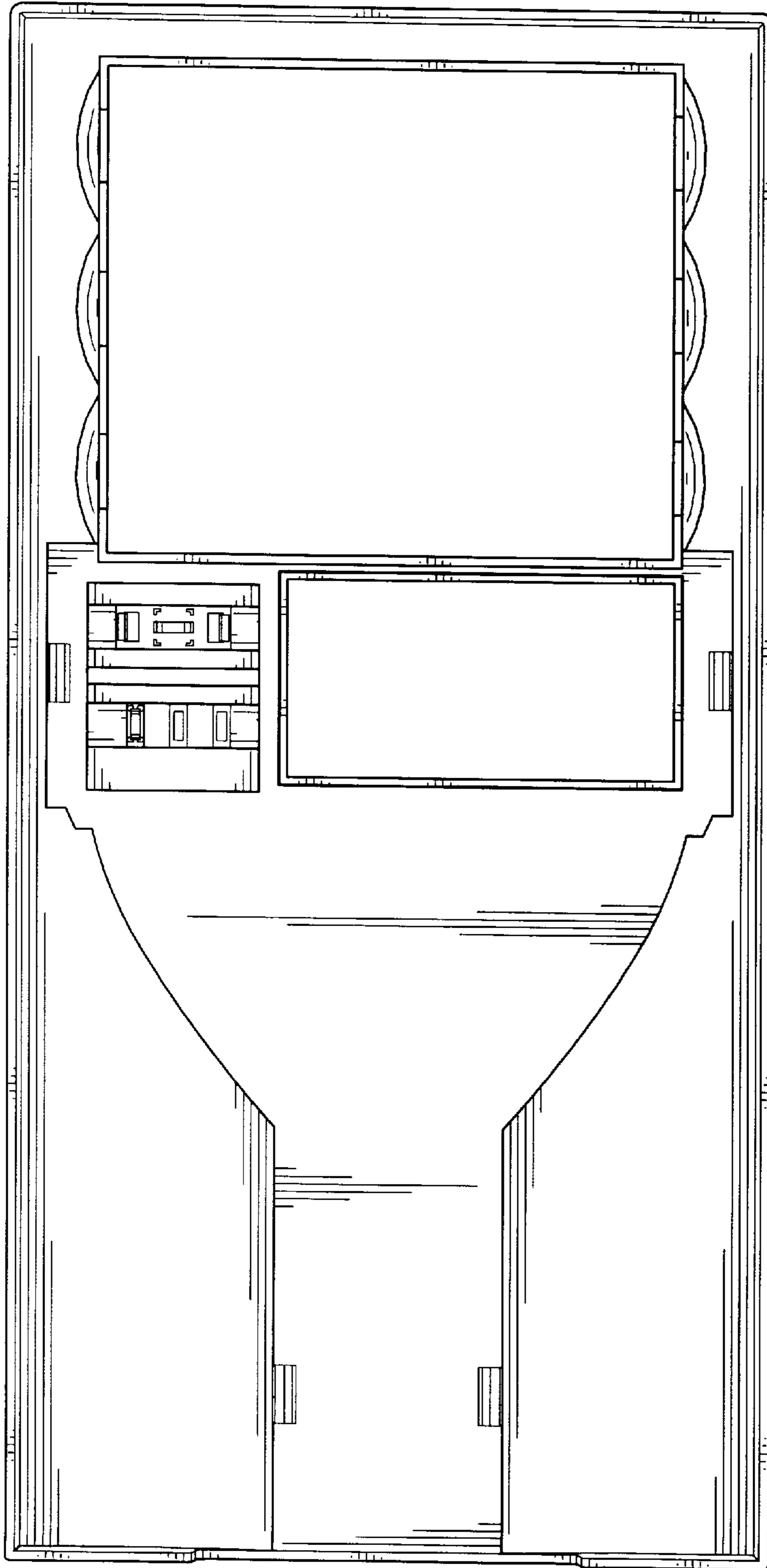

FIG. 3

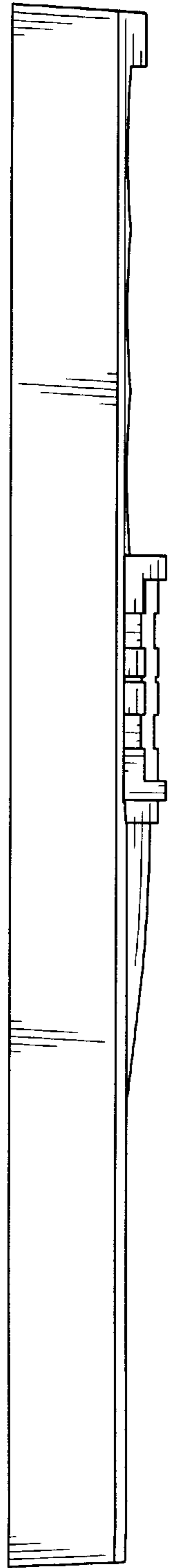

FIG. 4

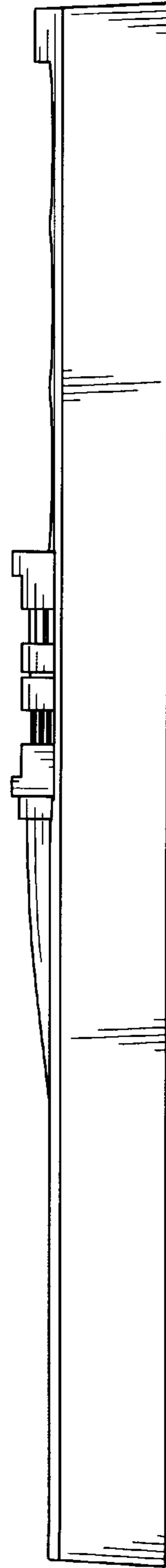

FIG. 5

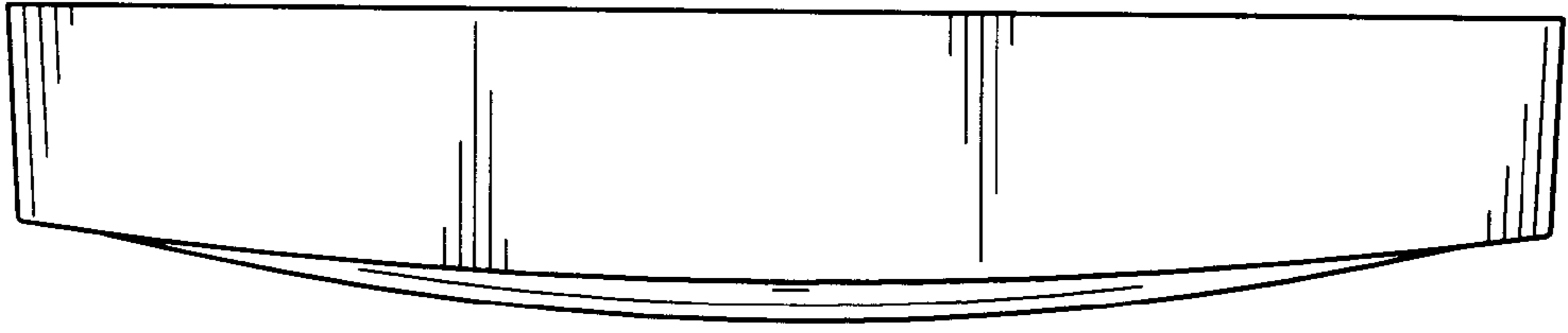

FIG. 6

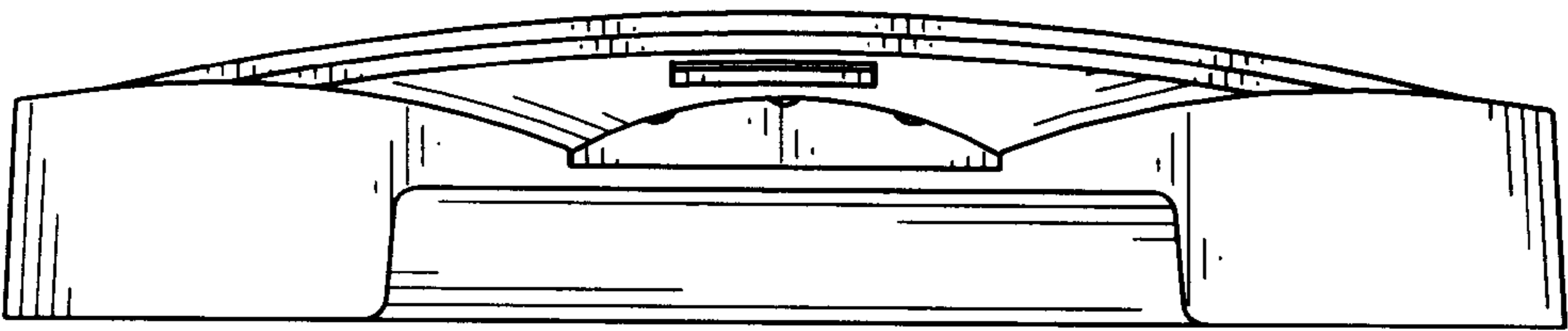

FIG. 7

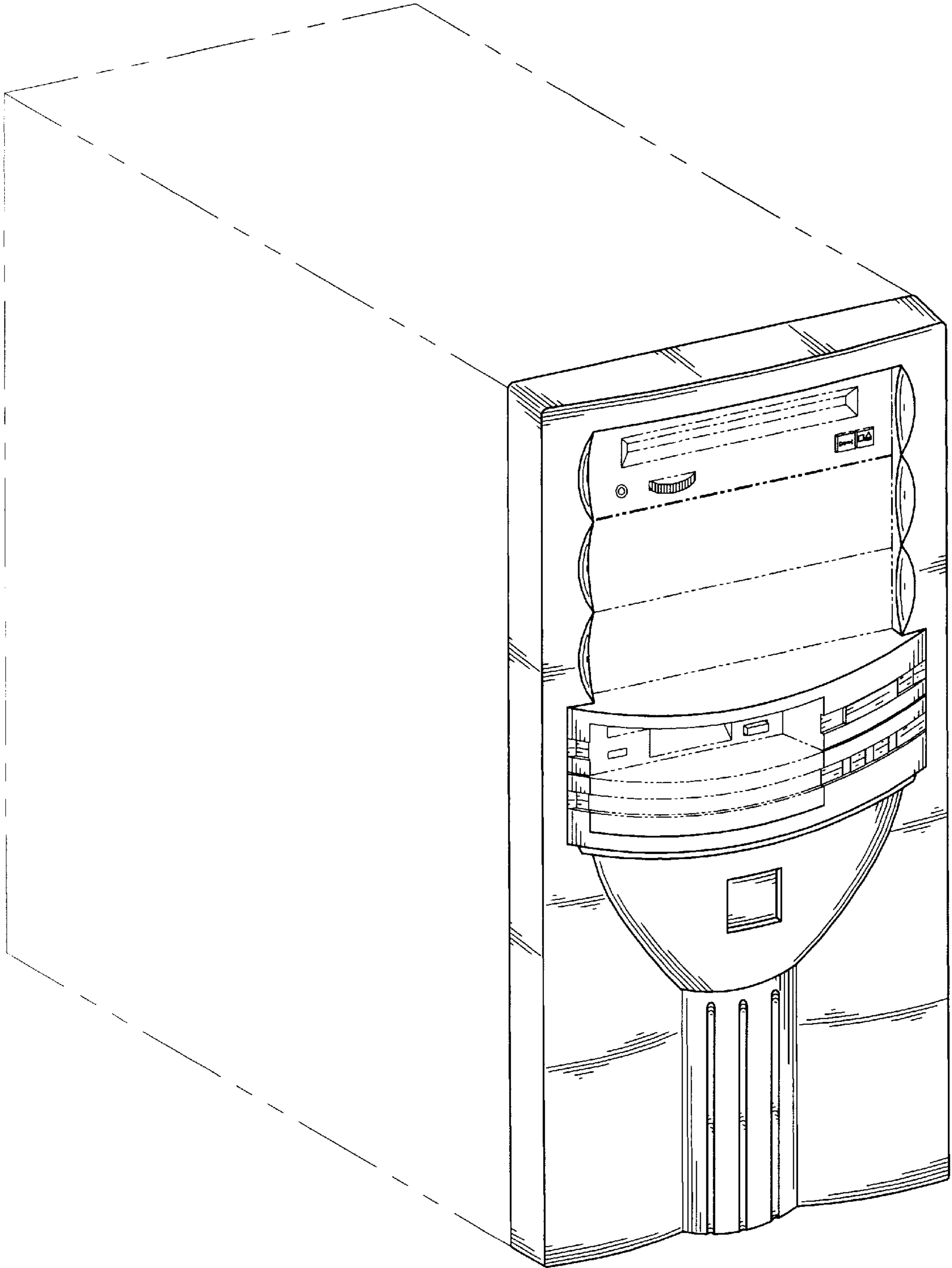

FIG. 8