



US00D433623S

**United States Patent** [19]  
**Crawford**

[11] **Patent Number: Des. 433,623**

[45] **Date of Patent: \*\* Nov. 14, 2000**

[54] **CONTAINER**

[75] Inventor: **John C. Crawford**, Mahopac, N.Y.

[73] Assignee: **Colgate-Palmolive Company**, New York, N.Y.

[\*\*] Term: **14 Years**

[21] Appl. No.: **29/090,393**

[22] Filed: **Jul. 8, 1998**

[51] **LOC (7) Cl.** ..... **09-01**

[52] **U.S. Cl.** ..... **D9/300; D9/542**

[58] **Field of Search** ..... D9/300, 530, 542,  
D9/543, 558, 573, 574; 222/321.1-321.9,  
324

[56] **References Cited**

**U.S. PATENT DOCUMENTS**

D. 229,889 1/1974 Brody ..... D9/542  
D. 281,861 12/1985 Jones et al. .... D9/542 X

D. 315,299 3/1991 Gerardiello ..... D9/558  
D. 337,496 7/1993 Laubach et al. .... D9/300  
D. 376,310 12/1996 Crawford ..... D9/300

*Primary Examiner*—James Gandy  
*Assistant Examiner*—Cathron B. Matta  
*Attorney, Agent, or Firm*—Michael McGreal

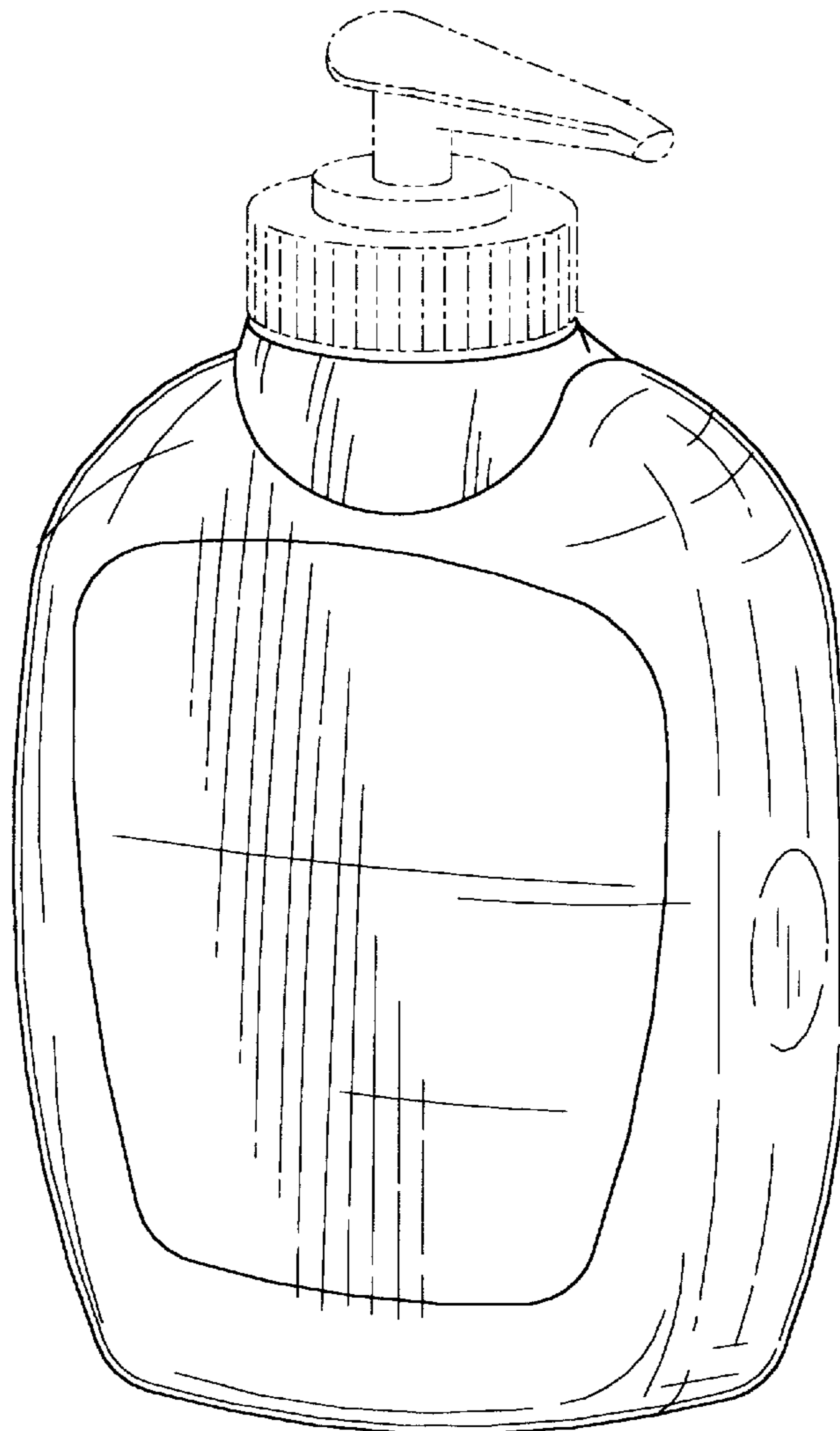
[57] **CLAIM**

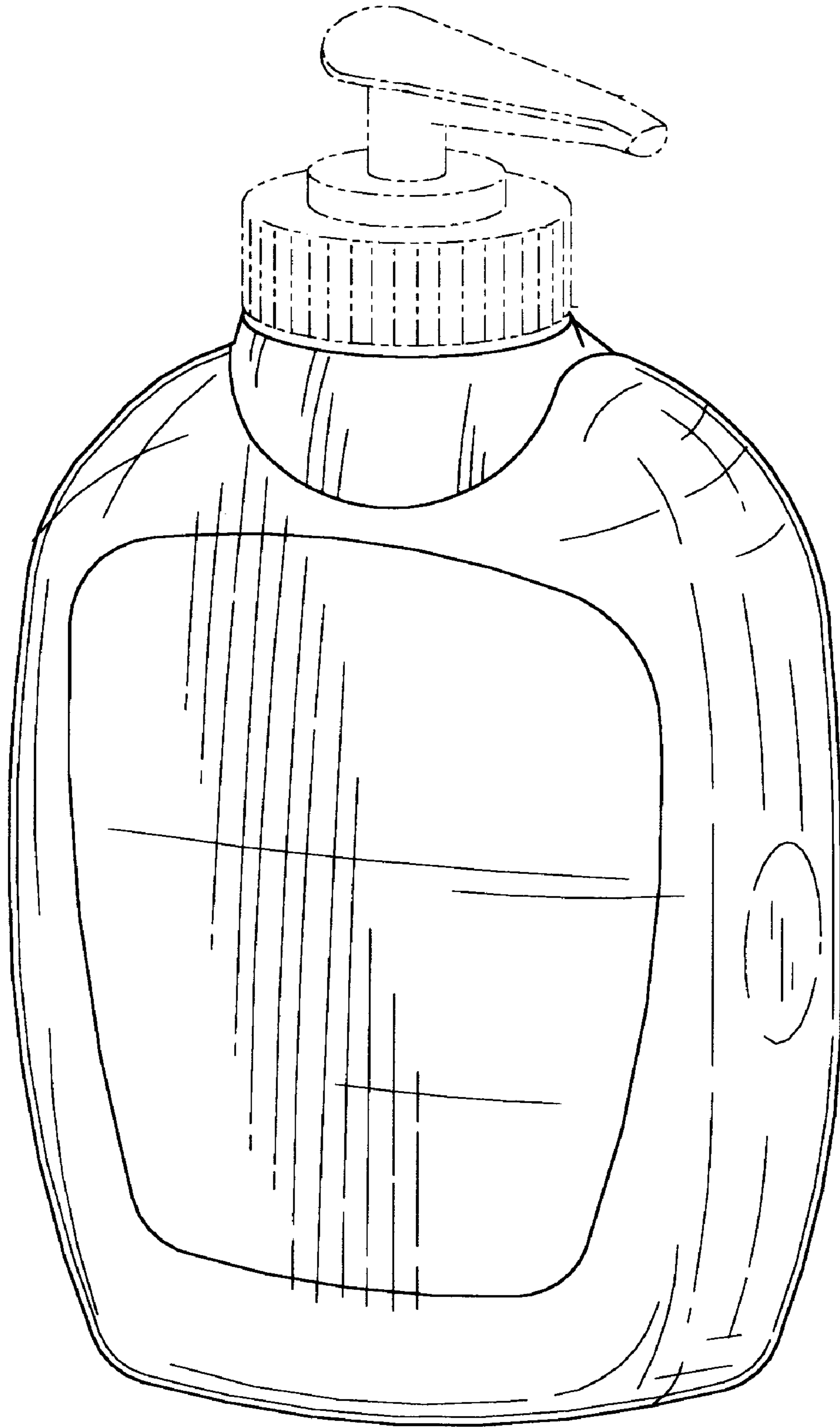
The ornamental design for a container, as shown and described.

**DESCRIPTION**

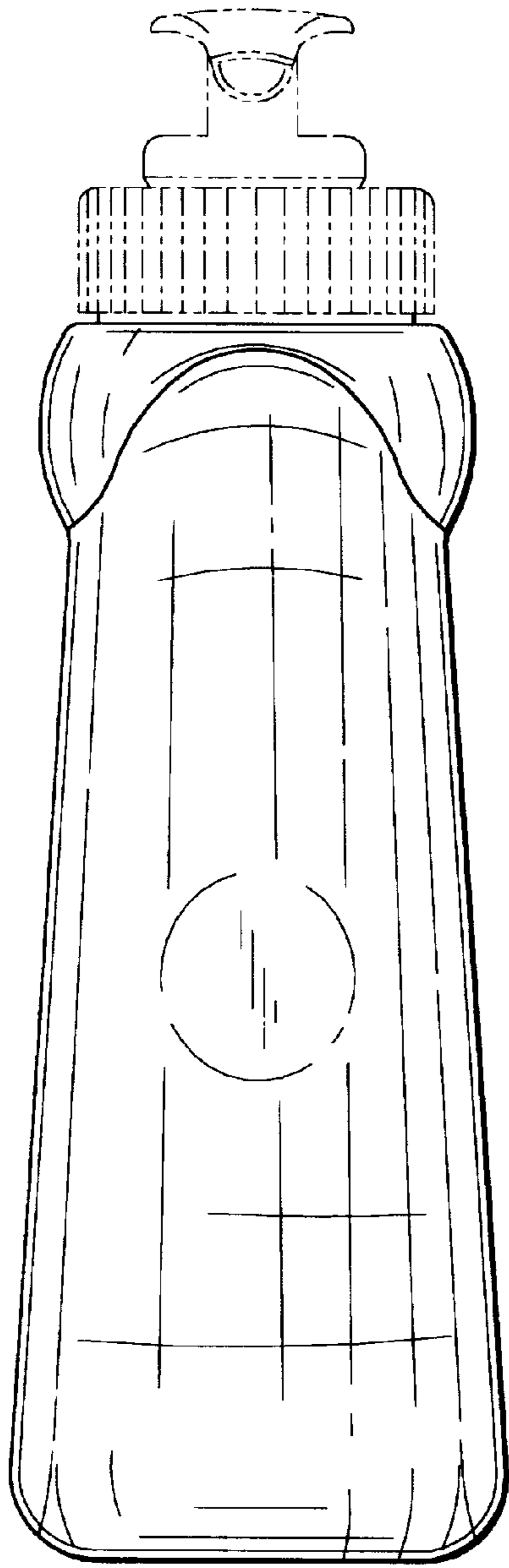
FIG. 1 is a perspective view of the container of my design.  
FIG. 2 is a right side elevation view.  
FIG. 3 is a left side elevation view thereof.  
FIG. 4 is a front and rear elevation view thereof.  
FIG. 5 is a top plan view thereof; and,  
FIG. 6 is a bottom plan view thereof.  
The broken line showing of a pump closure is for illustrative purposes only and forms no part of the claimed design.

**1 Claim, 3 Drawing Sheets**

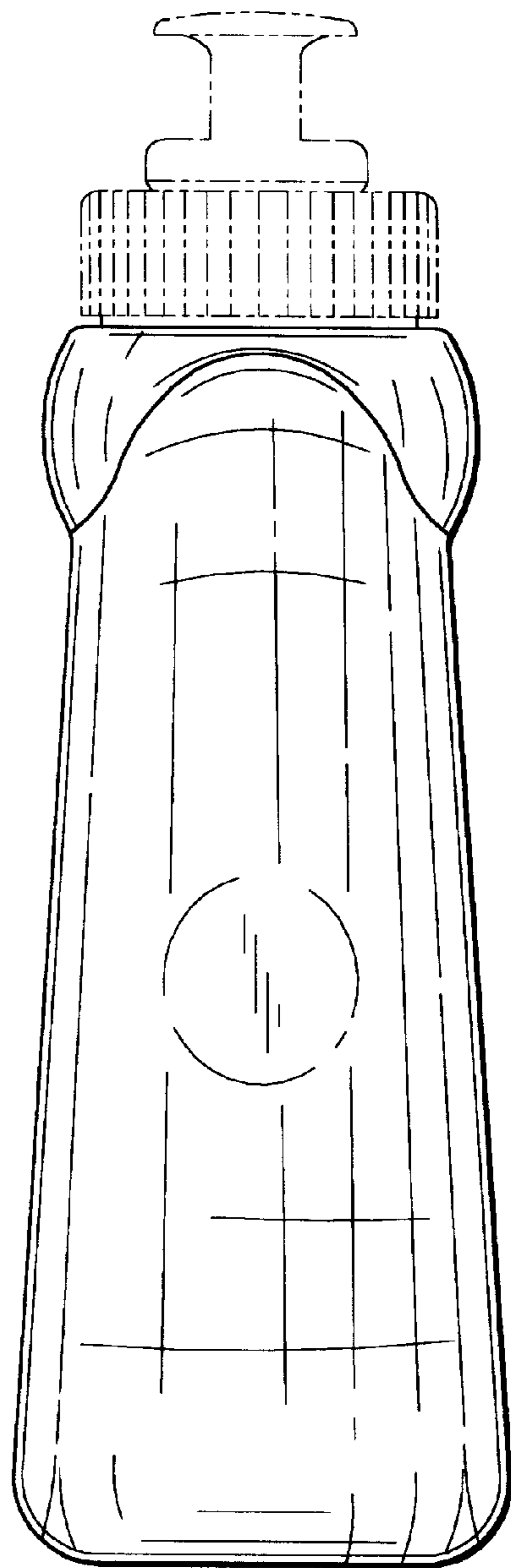




**FIG. 1**



*FIG. 2*



*FIG. 3*

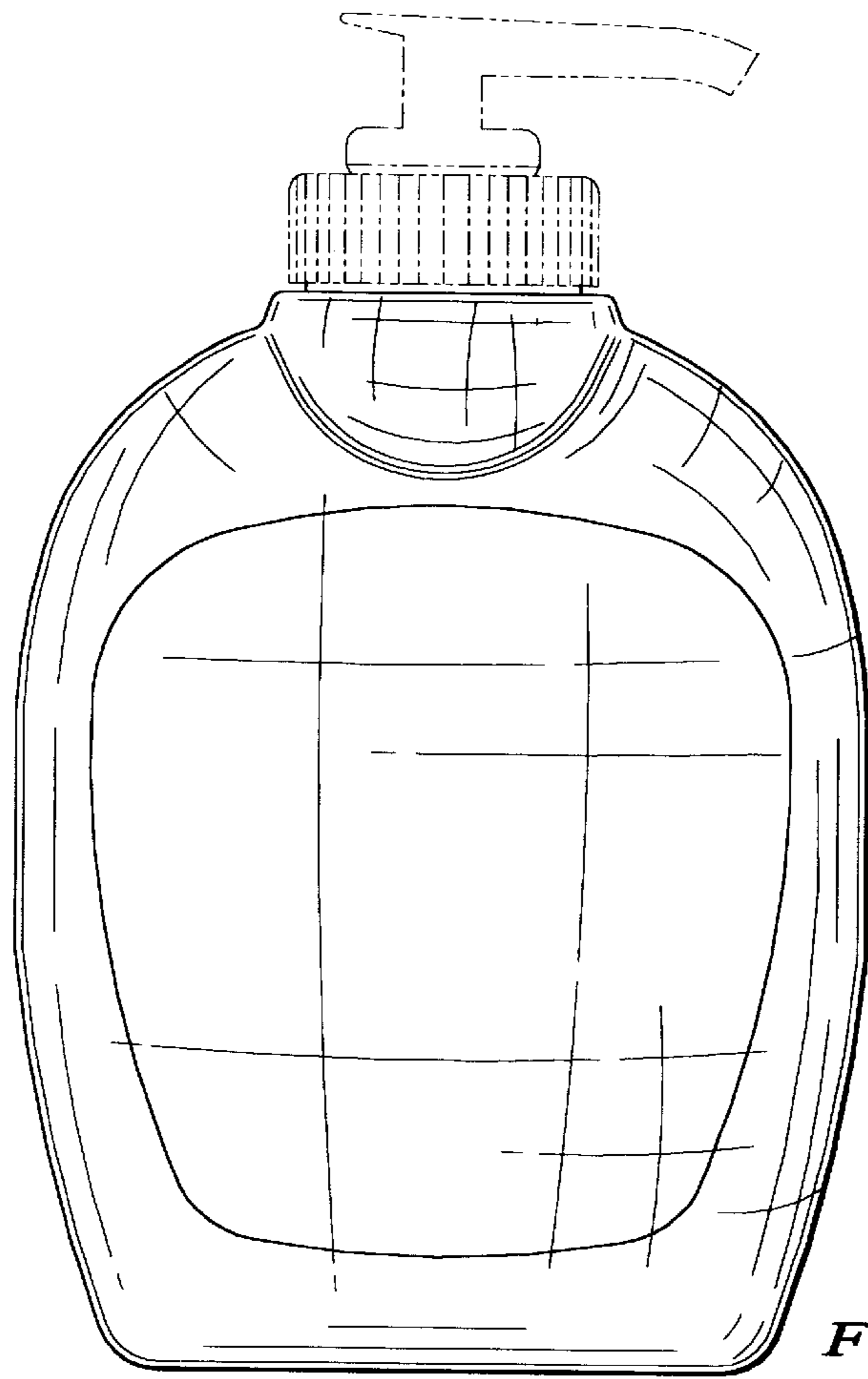


FIG. 4

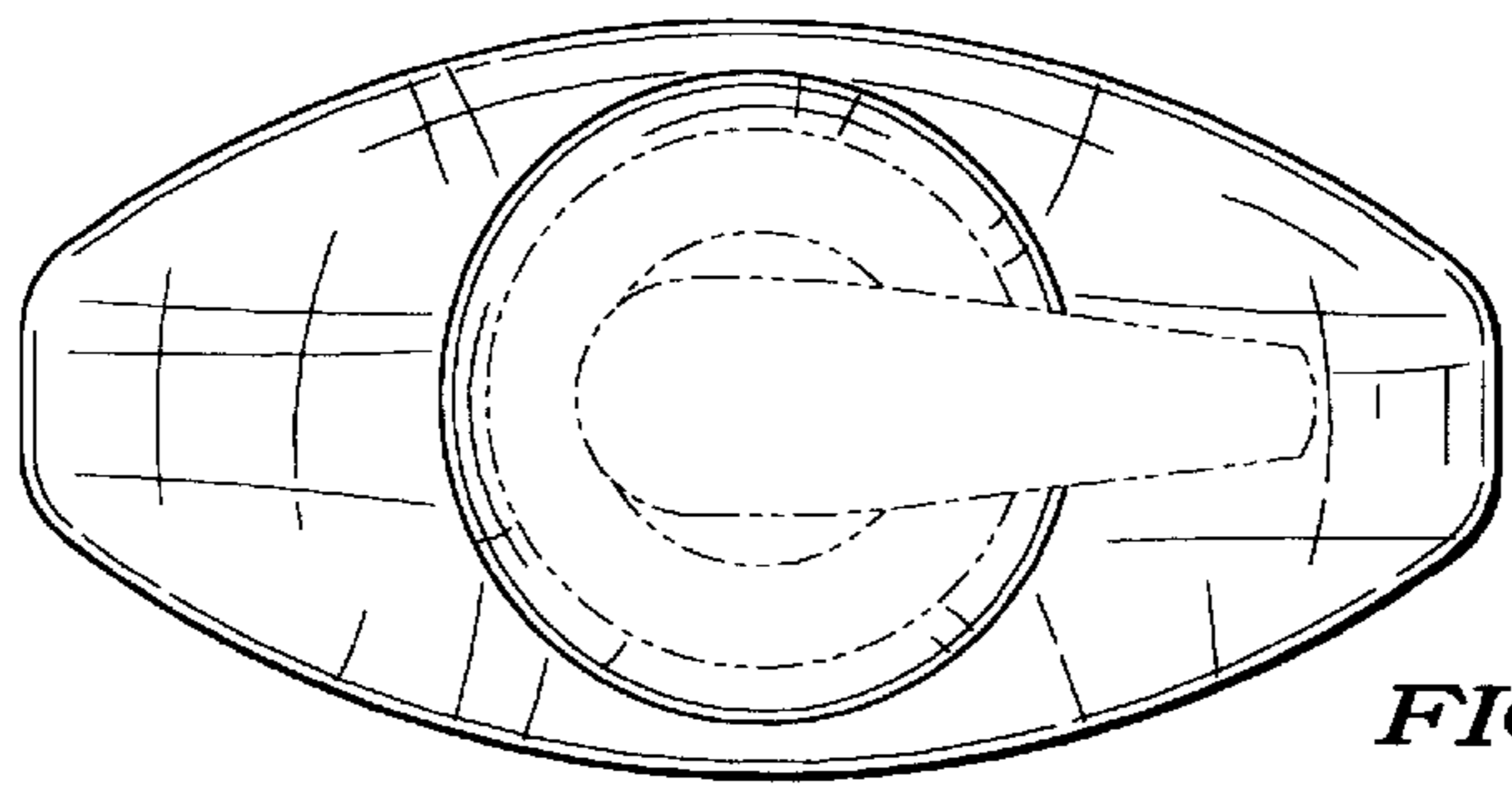


FIG. 5

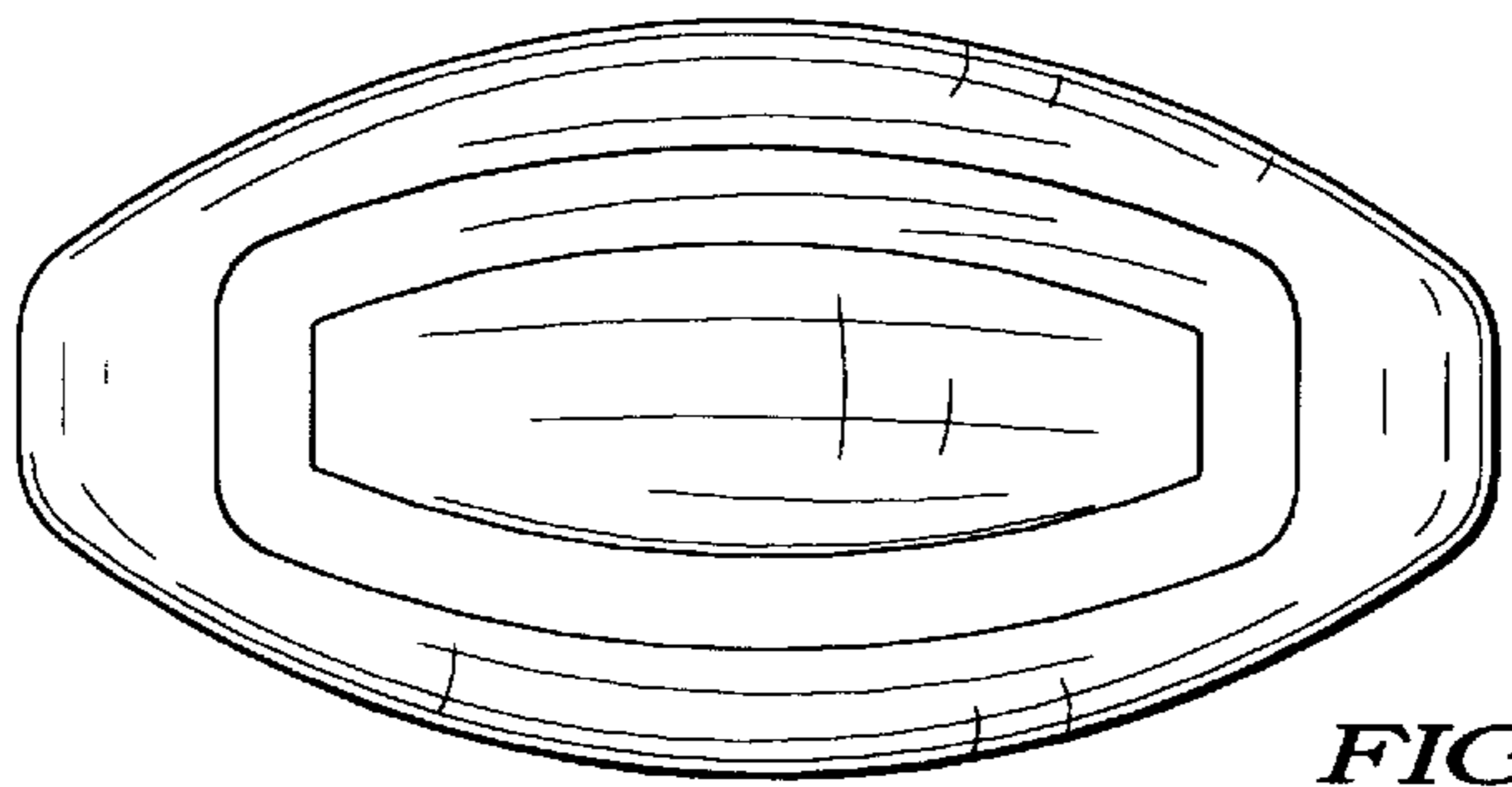


FIG. 6