



US00D433551S

United States Patent [19] Powell

[11] Patent Number: **Des. 433,551**

[45] Date of Patent: **** Nov. 7, 2000**

[54] **LAUNDRY IRON**

[75] Inventor: **Dick Powell**, London, United Kingdom

[73] Assignee: **Calor S.A.**, Lyons, France

[**] Term: **14 Years**

[21] Appl. No.: **29/108,275**

[22] Filed: **Jul. 23, 1999**

[30] **Foreign Application Priority Data**

Jan. 25, 1999 [FR] France 99 0574

[51] **LOC (7) Cl.** **07-05**

[52] **U.S. Cl.** **D32/70**

[58] **Field of Search** D32/68, 69, 70;
38/77.1, 77.2, 77.3, 77.4, 77.5, 74, 69,
79, 77.8, 77.7, 88; 219/245, 254, 273, 275

[56] **References Cited**

U.S. PATENT DOCUMENTS

- D. 362,944 10/1995 Sham et al. D32/70
- D. 365,184 12/1995 DeBlois et al. D32/70
- D. 386,863 11/1997 Lin D32/70
- D. 393,509 4/1998 Gudfin D32/70

- D. 402,779 12/1998 Gudfin D32/70
- D. 409,807 5/1999 Kondo D32/70
- D. 413,005 8/1999 Taylor D32/70
- 5,138,778 8/1992 Brandolini 38/77.8
- 5,509,221 4/1996 Patrick et al. 38/77.5

Primary Examiner—Susan J. Lucas
Assistant Examiner—Cynthia E. Ramirez
Attorney, Agent, or Firm—Cantor Colburn LLP

[57] **CLAIM**

The ornamental design for a laundry iron, as shown and described.

DESCRIPTION

FIG. 1 is a top and front perspective view of a laundry iron, showing my new design;
FIG. 2 is a side elevational view thereof taken from the left of FIG. 1;
FIG. 3 is a right side elevational view thereof taken from the right of FIG. 1;
FIG. 4 is a top plan view thereof;
FIG. 5 is a bottom plan view thereof;
FIG. 6 is a front elevational view thereof; and,
FIG. 7 is a rear elevational view thereof.

1 Claim, 7 Drawing Sheets

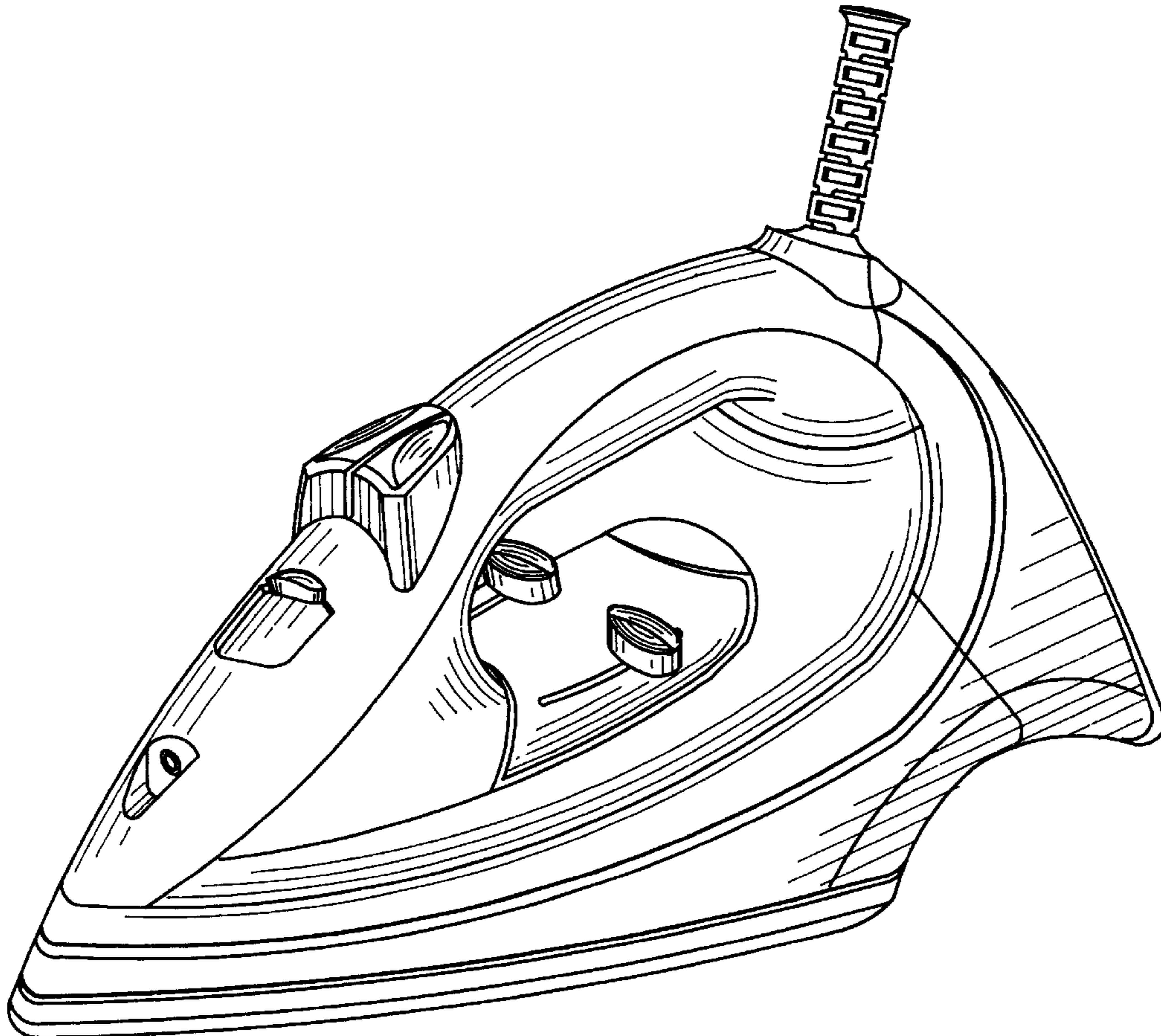

FIG. 1

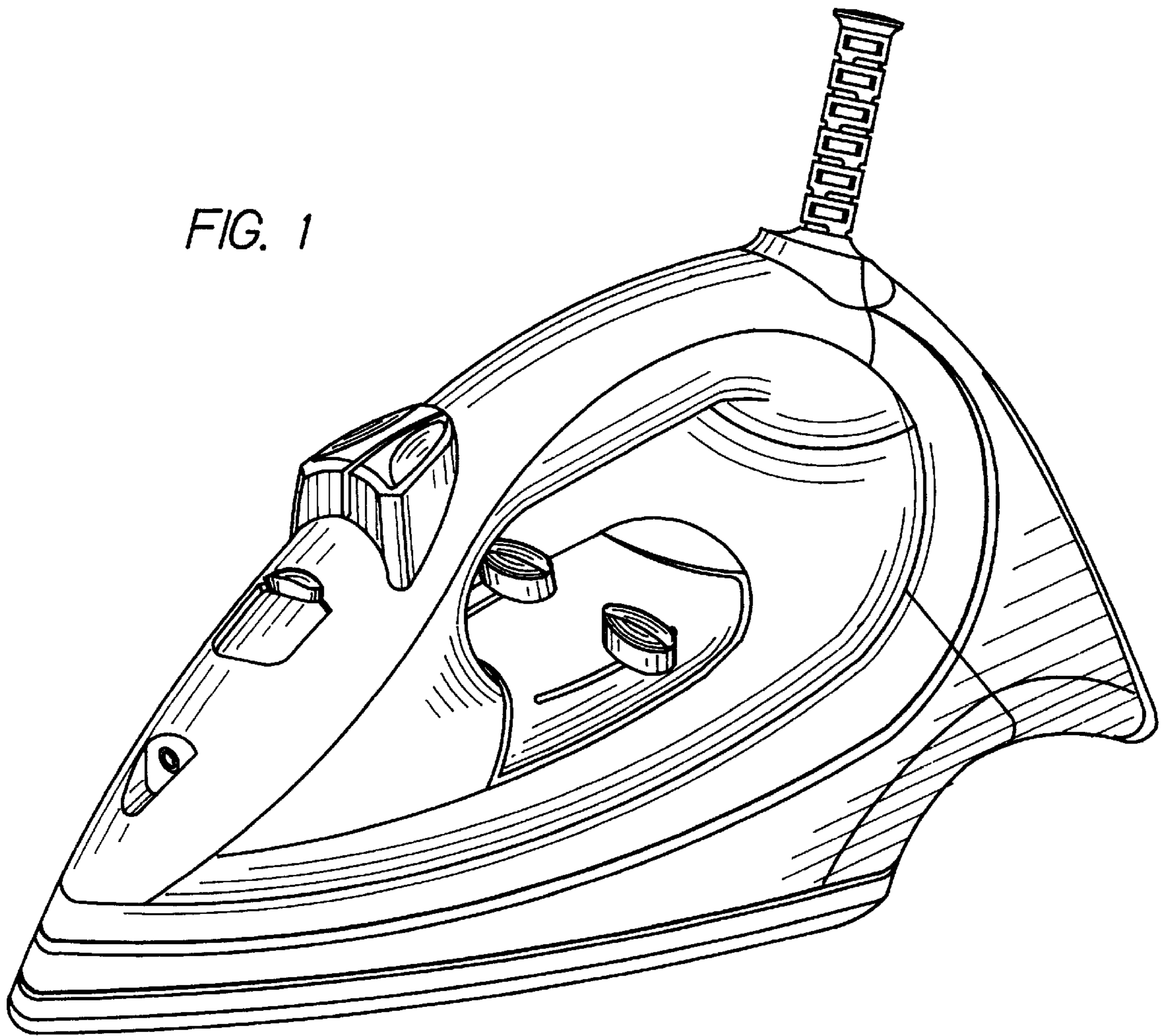

FIG. 2

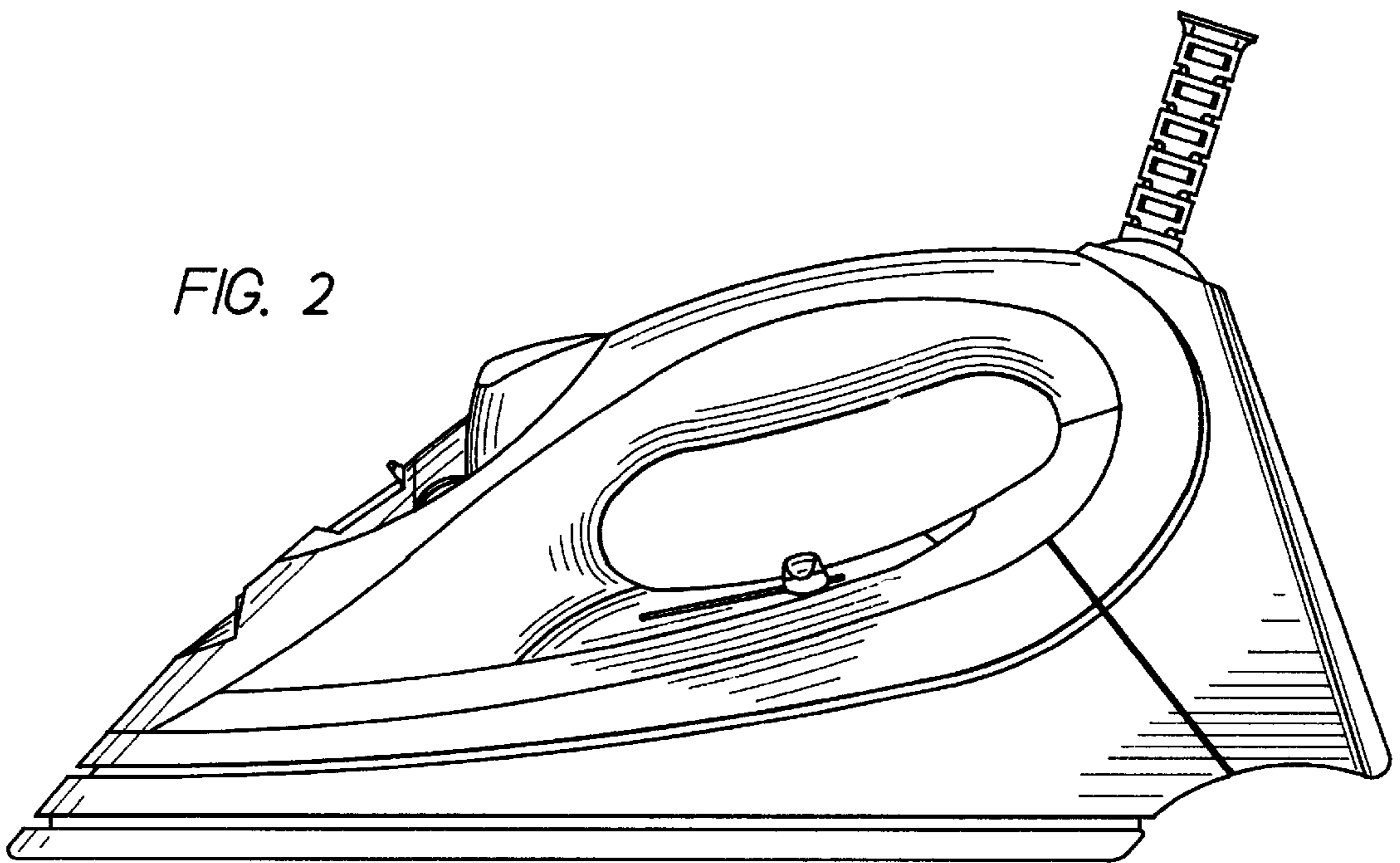

FIG. 3

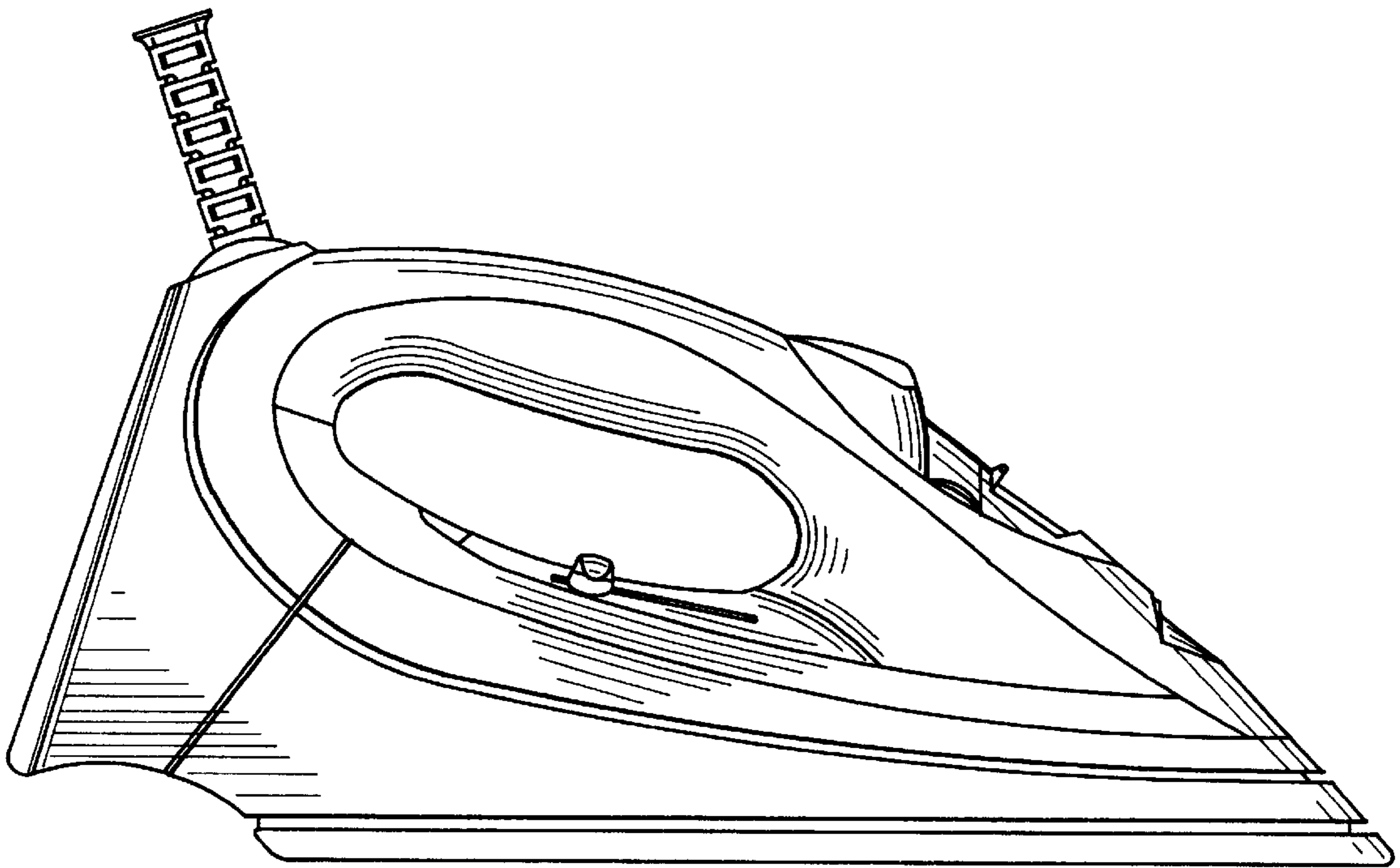

FIG. 4

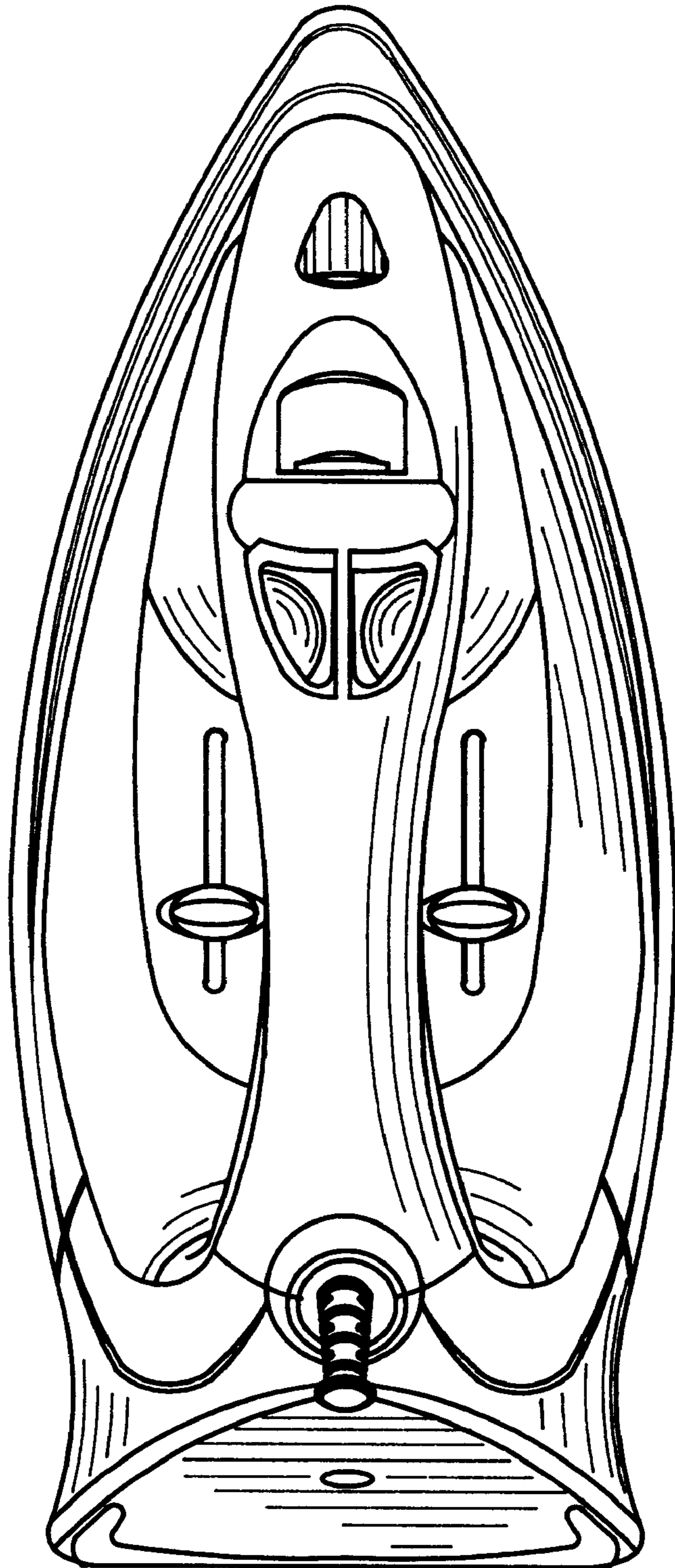

FIG. 5

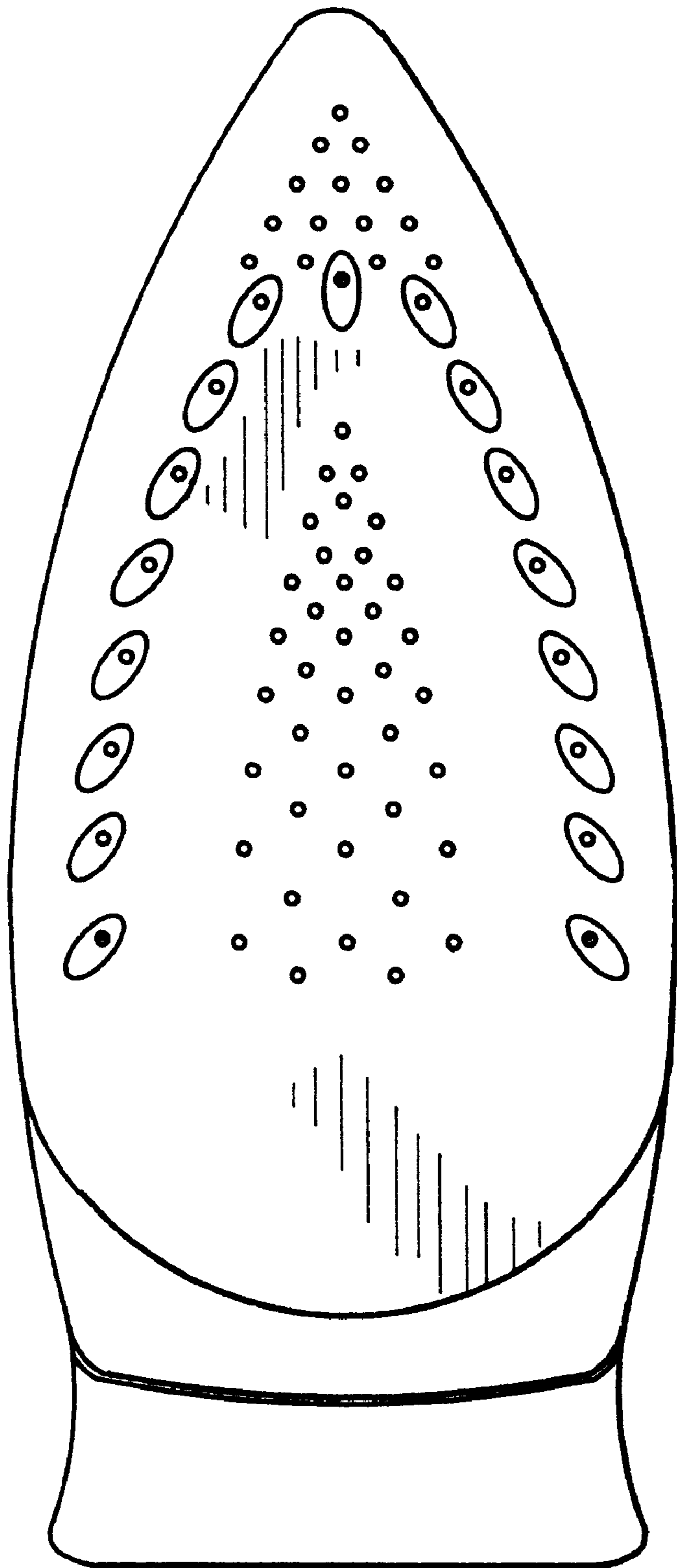

FIG. 6

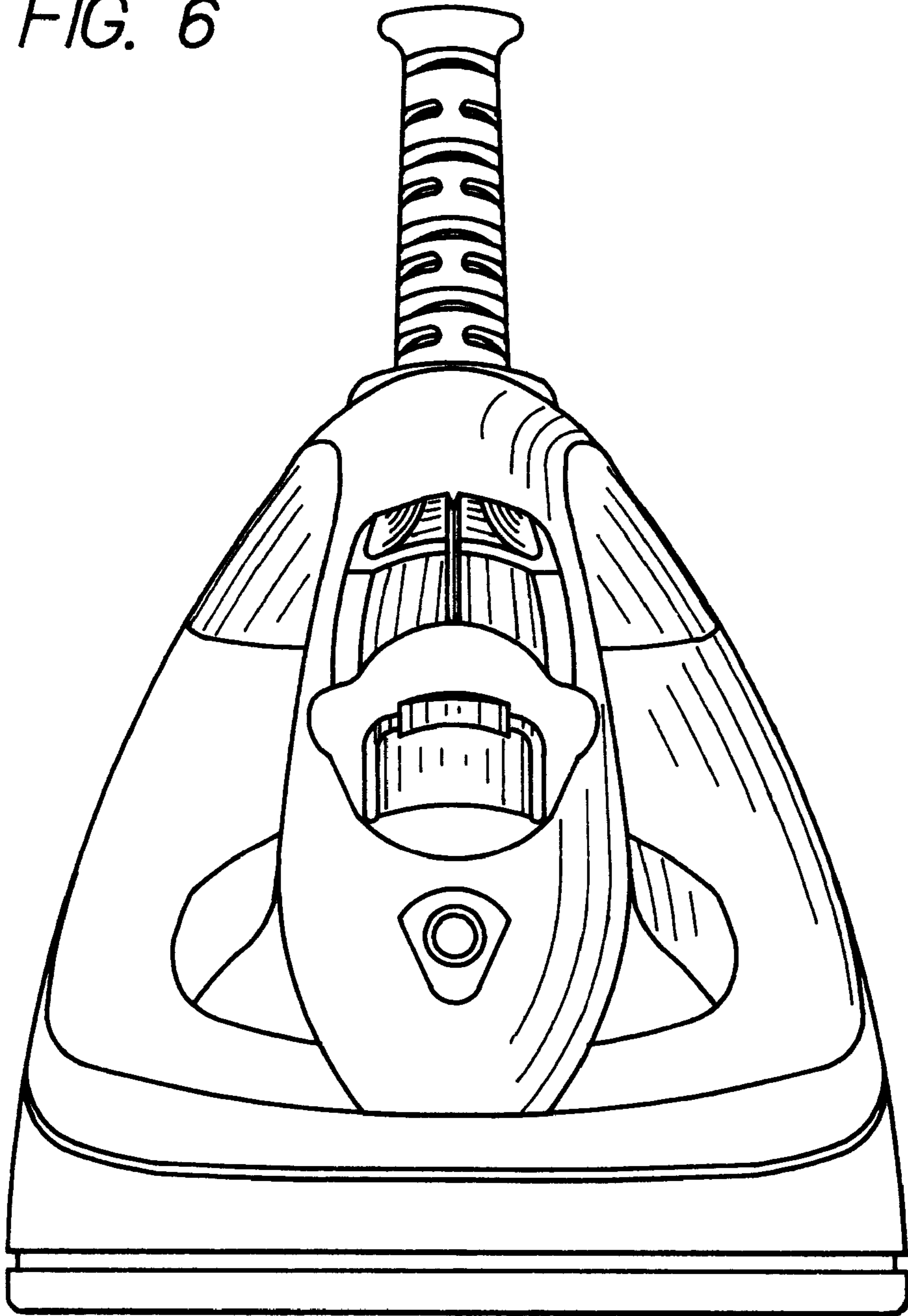

FIG. 7

