



US00D433524S

United States Patent [19] Szymanek

[11] **Patent Number: Des. 433,524**

[45] **Date of Patent: ** Nov. 7, 2000**

[54] **LIGHT FIXTURE**

D. 404,161 1/1999 Herst et al. D26/26

[75] Inventor: **D. David Szymanek**, Thousand Oaks, Calif.

OTHER PUBLICATIONS

Lighting magazine, Feb. 1959, MUS lighting fixture.

[73] Assignee: **Thin-Lite Corporation**, Camarillo, Calif.

Primary Examiner—Susan J. Lucas
Attorney, Agent, or Firm—Fulwider Patton Lee & Utecht, LLP

[**] Term: **14 Years**

[21] Appl. No.: **29/112,799**

[57] CLAIM

[22] Filed: **Oct. 25, 1999**

The ornamental design for a light fixture, as shown and described.

Related U.S. Application Data

DESCRIPTION

[63] Continuation-in-part of application No. 29/104,949, May 17, 1999.

FIG. 1 is a broken bottom perspective view showing my new design;

[51] **LOC (7) Cl.** **26-05**

FIG. 2 is a broken front view, in enlarged scale, thereof;

[52] **U.S. Cl.** **D26/76**

FIG. 3 is a broken bottom view, in enlarged scale, thereof;

[58] **Field of Search** D26/75-78; 362/216, 362/217, 218, 219, 220, 221, 222, 223, 224, 225

FIG. 4 is a right hand end view, in enlarged scale, thereof;

FIG. 5 is a broken top view, in enlarged scale, thereof; and,

FIG. 6 is a left end view, in enlarged scale, thereof.

[56] References Cited

The light fixture is broken away in FIGS. 1, 2, 3 and 4 to indicate indeterminate length.

U.S. PATENT DOCUMENTS

D. 333,530 2/1993 Boundy D26/76 X

1 Claim, 3 Drawing Sheets

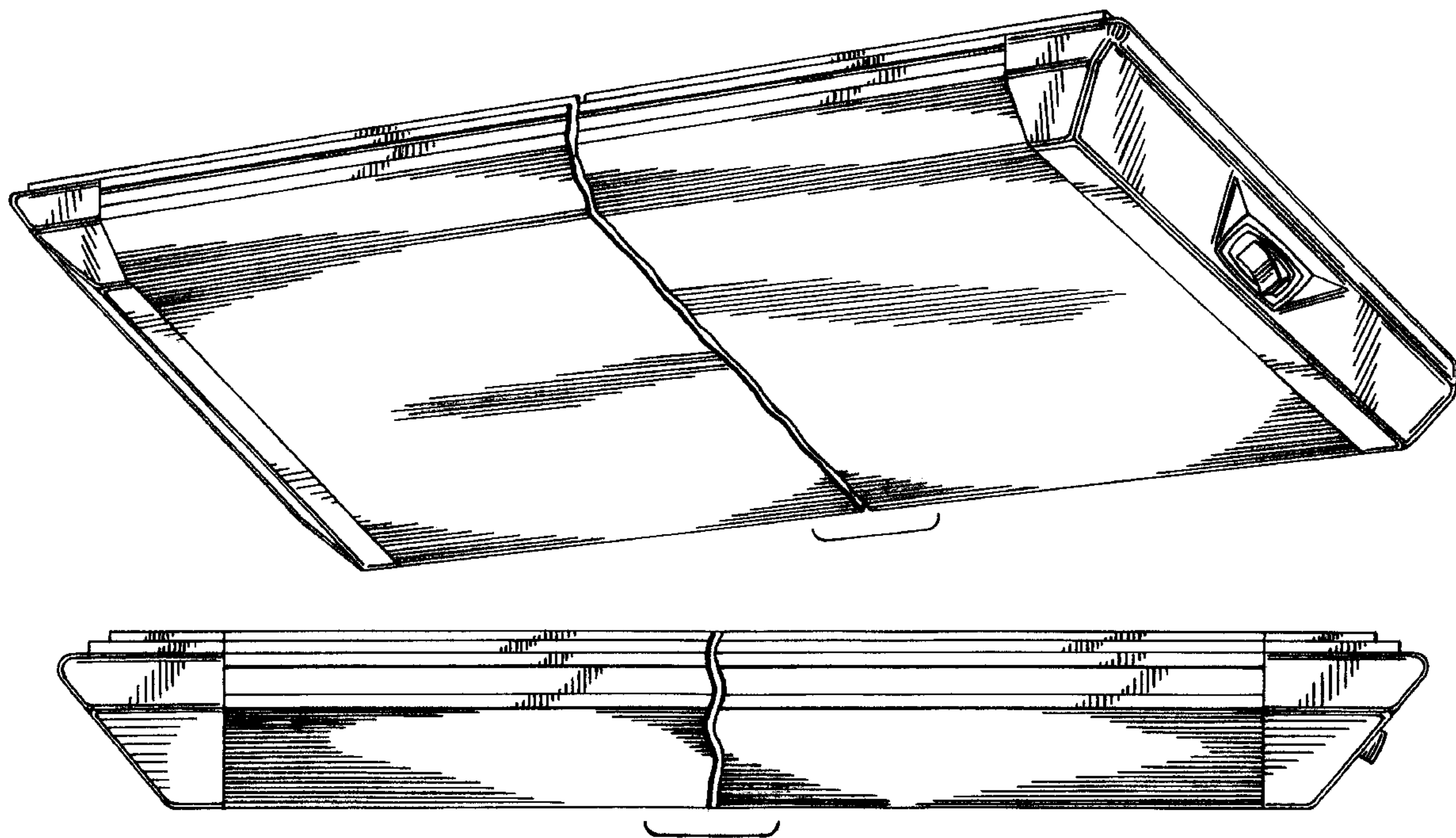

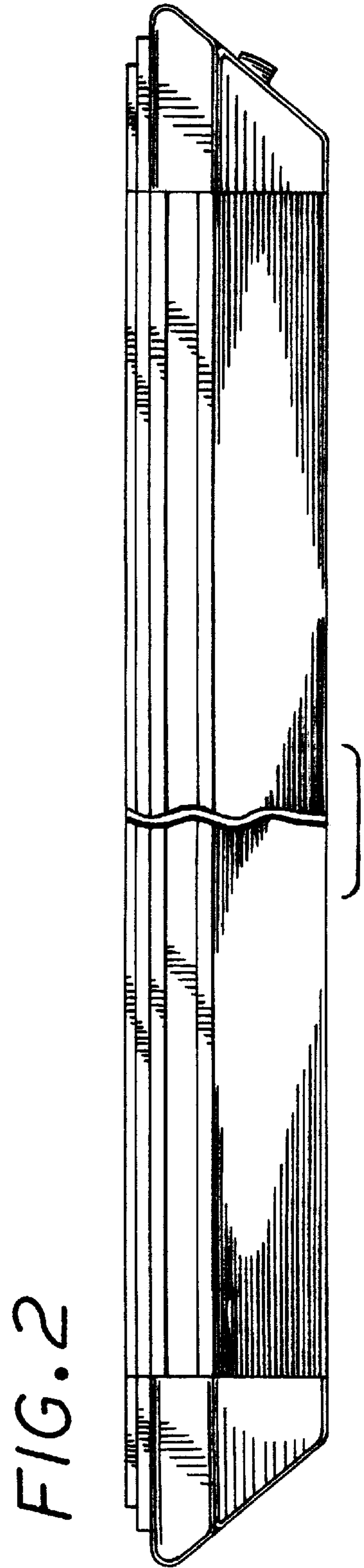
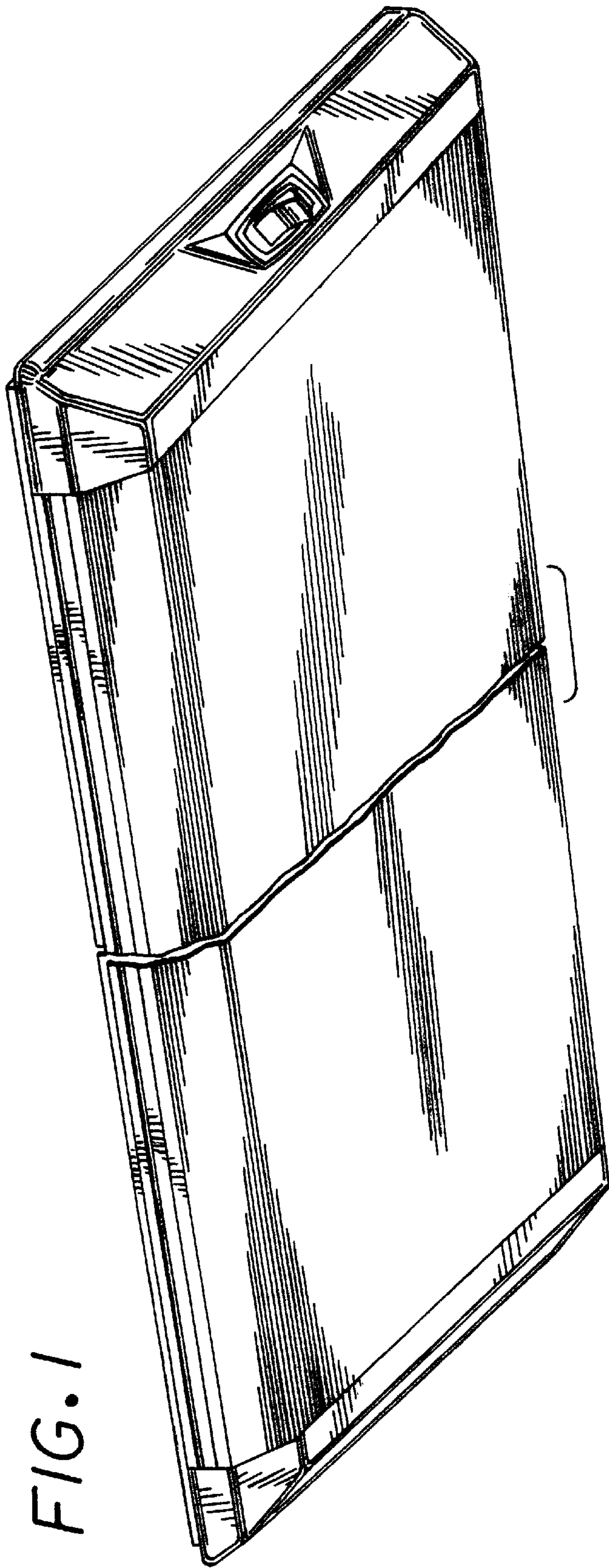

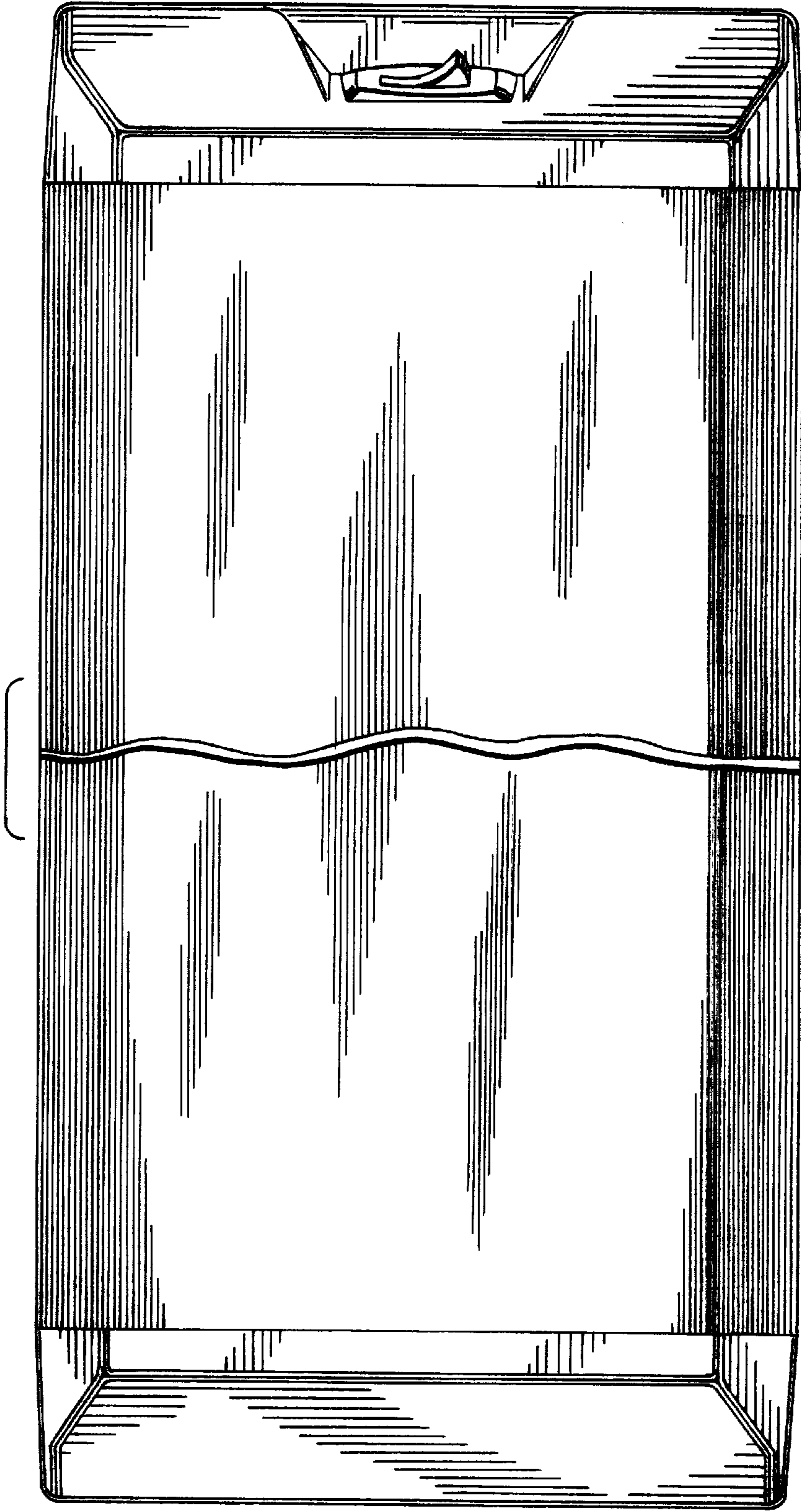

FIG. 3

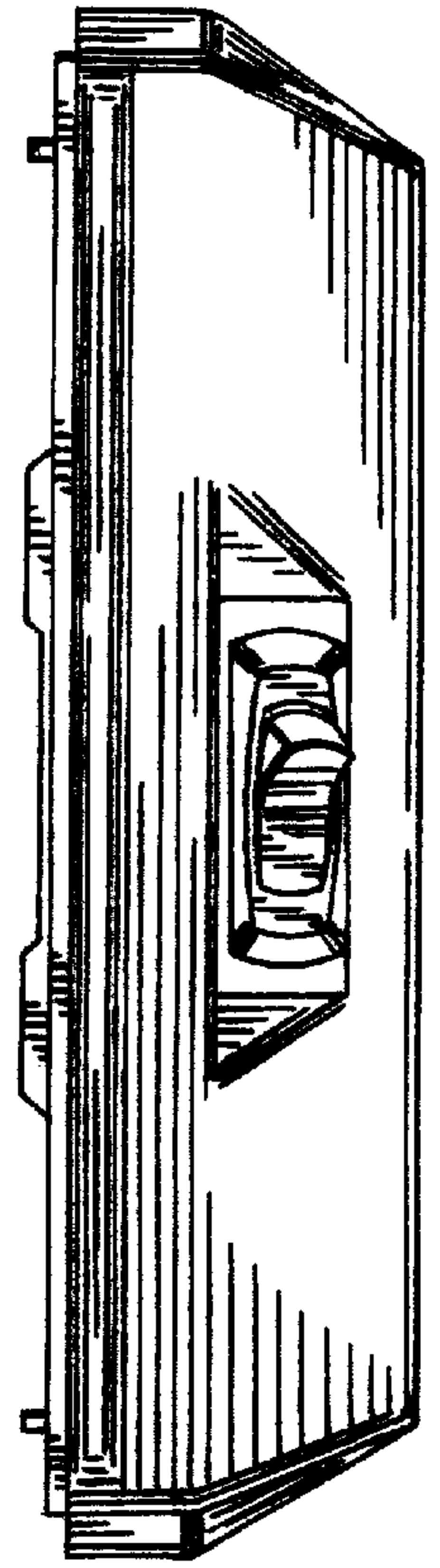

FIG. 4

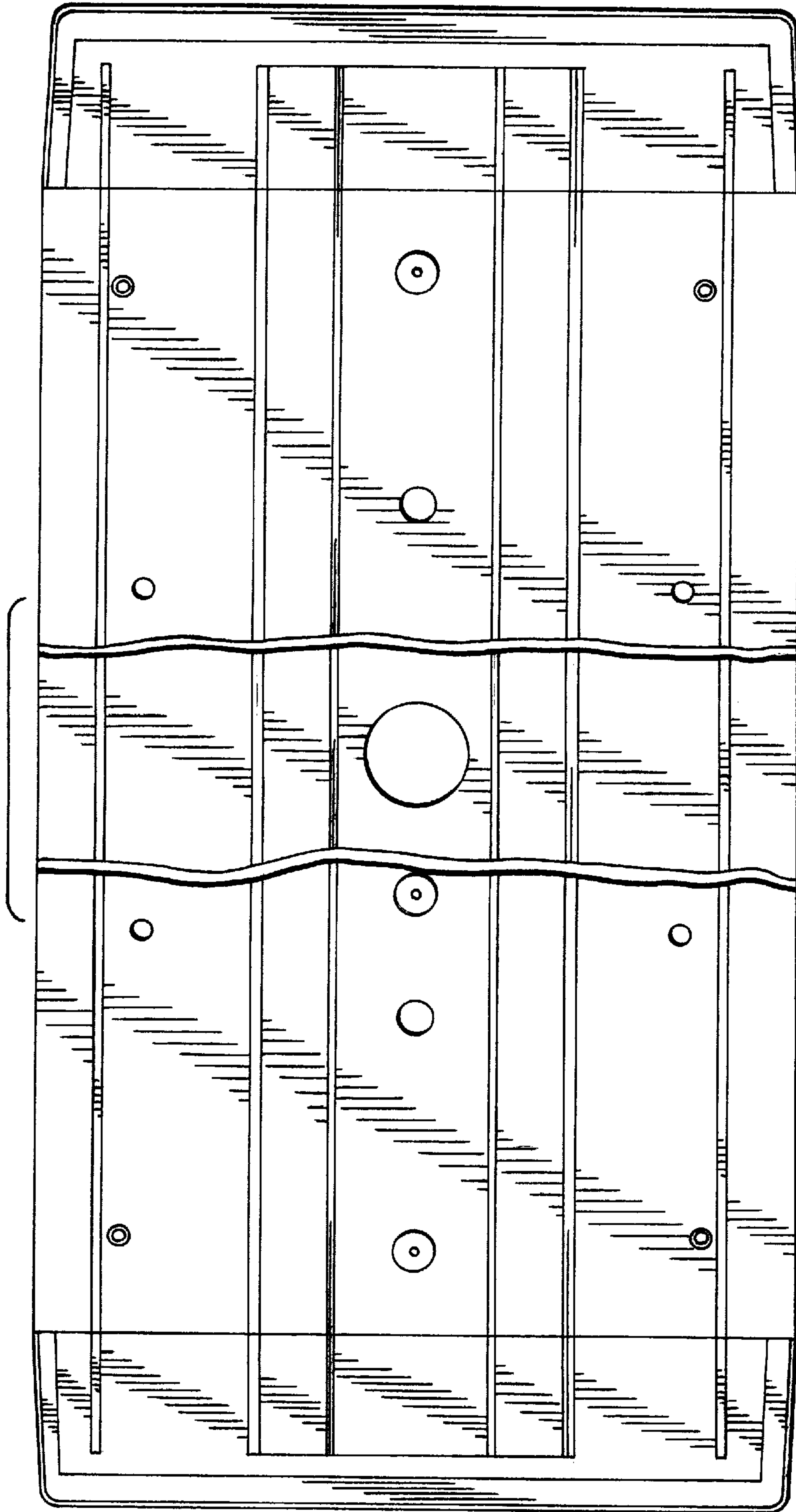

FIG. 5

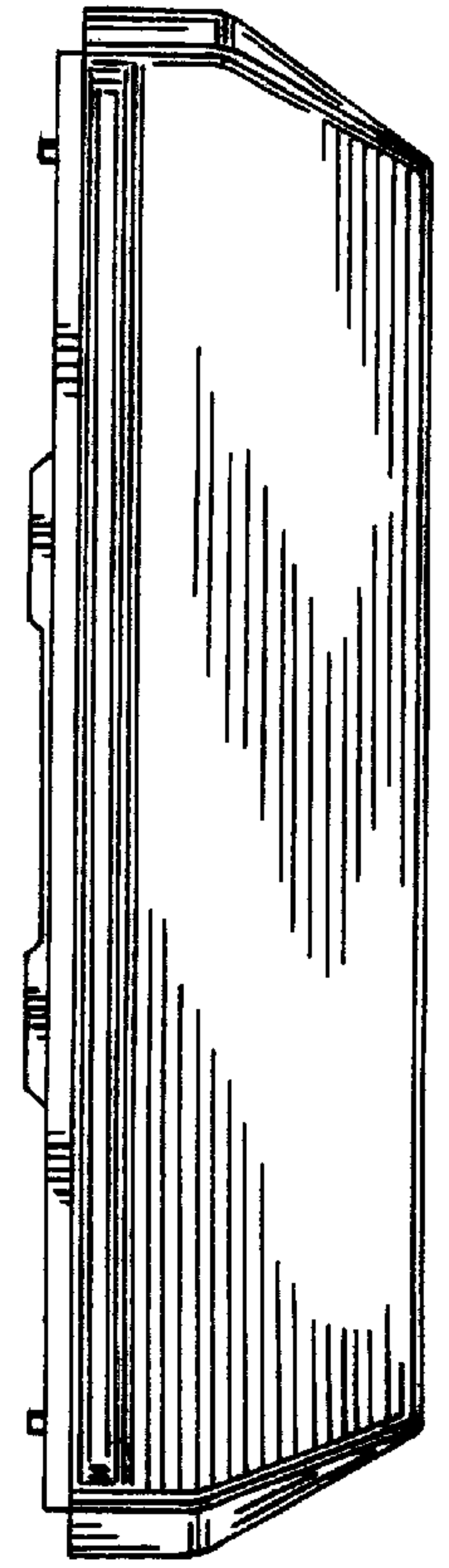

FIG. 6