



US00D433461S

United States Patent [19] Goto

[11] Patent Number: Des. 433,461

[45] Date of Patent: ** Nov. 7, 2000

[54] **GAME MACHINE**

[75] Inventor: **Teiyu Goto**, Tokyo, Japan

[73] Assignee: **Sony Computer Entertainment Inc.**,
Japan

[**] Term: **14 Years**

[21] Appl. No.: **29/121,505**

[22] Filed: **Apr. 10, 2000**

Related U.S. Application Data

[62] Division of application No. 29/099,764, Jan. 28, 1999.

[51] **LOC (7) Cl.** **21-01**

[52] **U.S. Cl.** **D21/330**

[58] **Field of Search** D21/324-330;
273/148 B; 463/1, 29-35, 46, 47

[56] **References Cited**

U.S. PATENT DOCUMENTS

D. 376,822	12/1996	Osterhout	D21/329
D. 383,798	9/1997	Yokoi et al.	D21/331
D. 399,267	10/1998	Fai	D21/329
D. 400,617	11/1998	Tsai	D21/330
D. 401,297	11/1998	Fai	D21/329
D. 402,708	12/1998	Tai	D21/330
D. 405,125	2/1999	Yokoi	D21/329
D. 407,122	3/1999	Tsai	D21/330
D. 407,760	4/1999	Yokoi	D21/329
D. 410,500	6/1999	Toma et al.	D21/329
D. 412,186	7/1999	Goto	D21/330
5,046,739	9/1991	Reichow	273/148 B X
5,161,803	11/1992	Ohara	463/46 X
5,184,830	2/1993	Okada et al.	463/29
5,212,368	5/1993	Hara	463/46 X
5,213,327	5/1993	Kitaue	463/38

OTHER PUBLICATIONS

Hong Kong Enterprise, p. 133.

Hong Kong Enterprise, p. 1183.

“The Point Network No. 39,” (Dec. 20, 1997).

Advertisement Flyer of Itoyokado for Jan. 1-4, 1999.

Primary Examiner—Prabhakah Deshmukh

Attorney, Agent, or Firm—Rader, Fishman&Grauer

[57] **CLAIM**

The ornamental design for a game machine, as shown and described.

DESCRIPTION

FIG. 1 is a perspective view of a first embodiment of a game machine showing my new design;

FIG. 2 is a top plan view design;

FIG. 3 is a left side elevational view thereof;

FIG. 4 is a front elevational view thereof;

FIG. 5 is a bottom plan view thereof;

FIG. 6 is a right side elevational view thereof; and

FIG. 7 is a rear elevational view thereof.

FIG. 8 is another perspective view thereof, wherein the cover portion is in the open position.

FIG. 9 is a perspective view of a second embodiment of a game machine showing my new design;

FIG. 10 is a top plan view thereof;

FIG. 11 is a left side elevational view thereof;

FIG. 12 is a front elevational view thereof;

FIG. 13 is a bottom plan view thereof;

FIG. 14 is a right side elevational view thereof; and

FIG. 15 is a rear elevational view thereof; and,

FIG. 16 is another perspective view thereof, wherein the cover portion is in the open position.

1 Claim, 8 Drawing Sheets

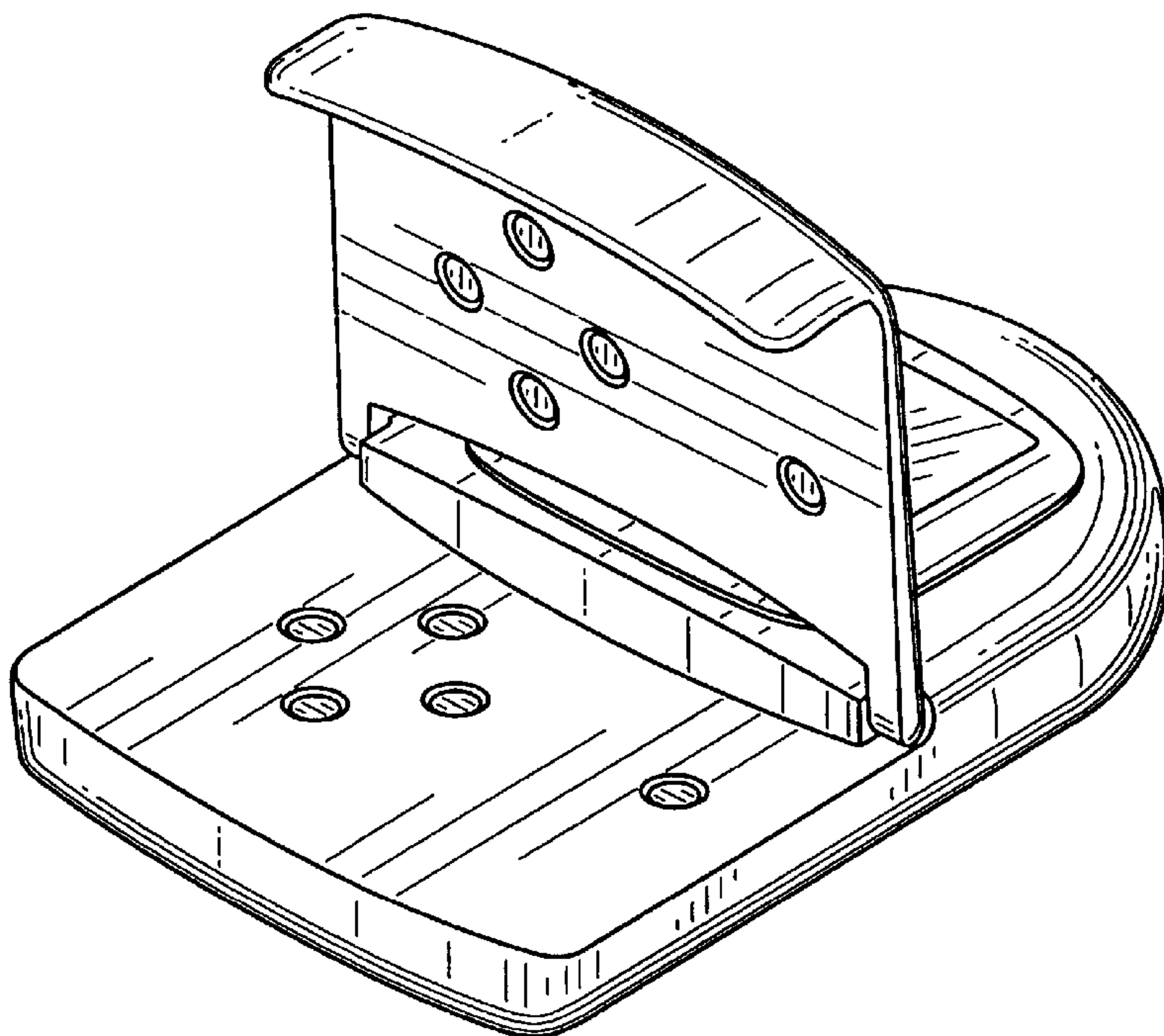

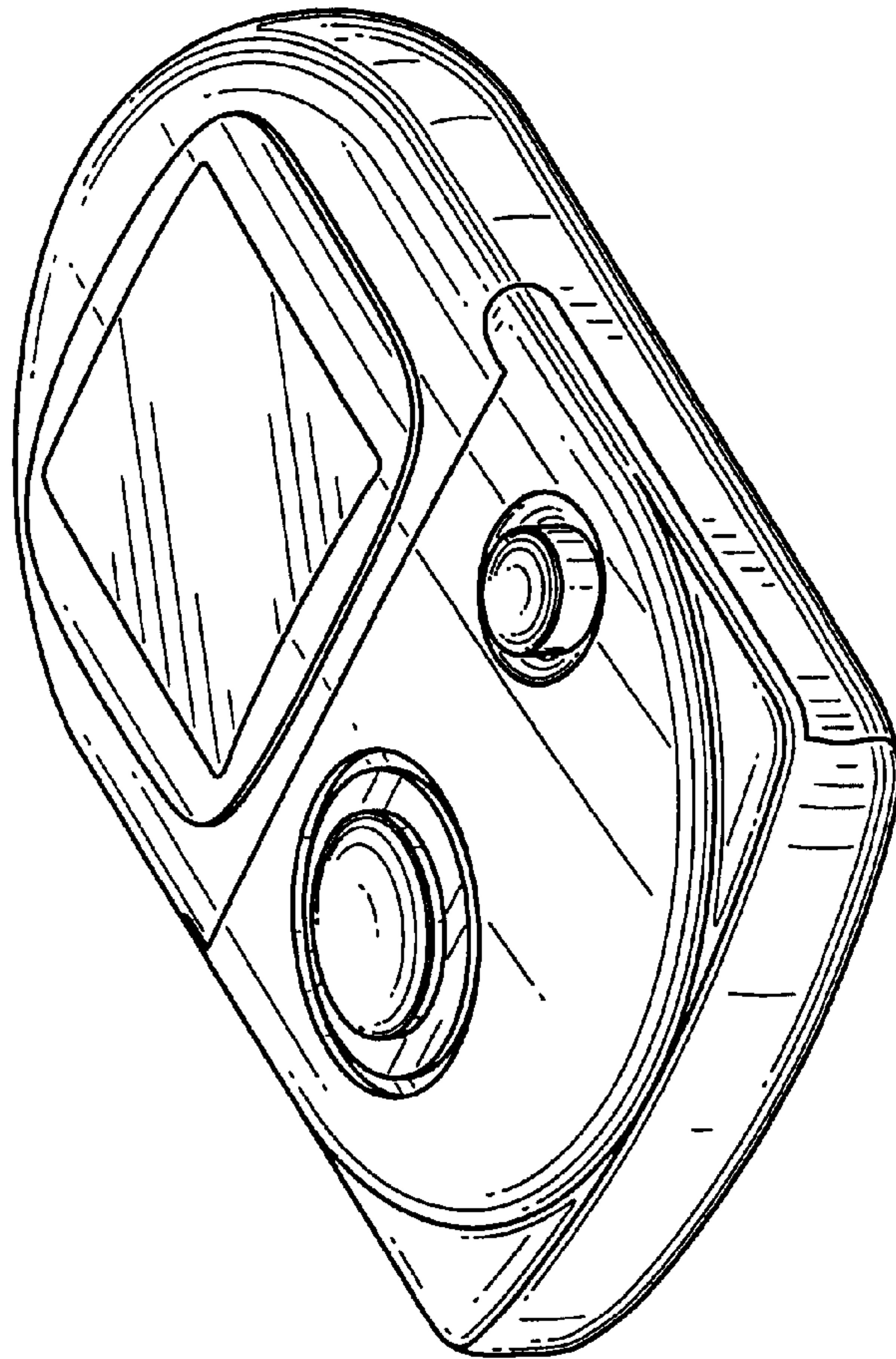

FIG. 1

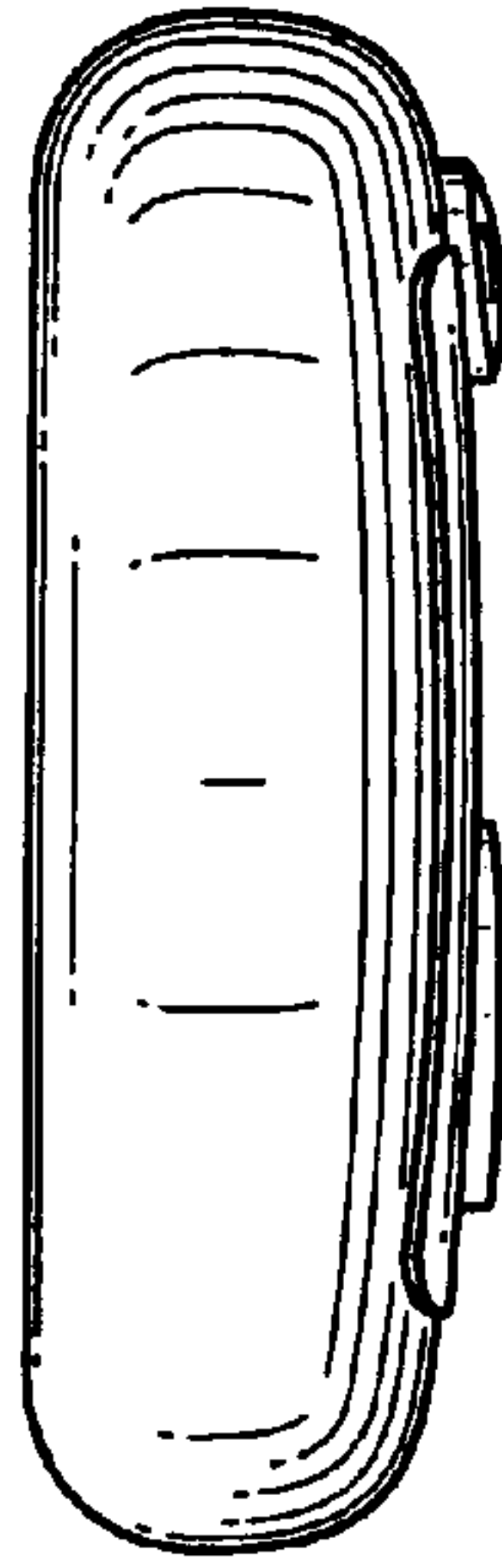

FIG. 2

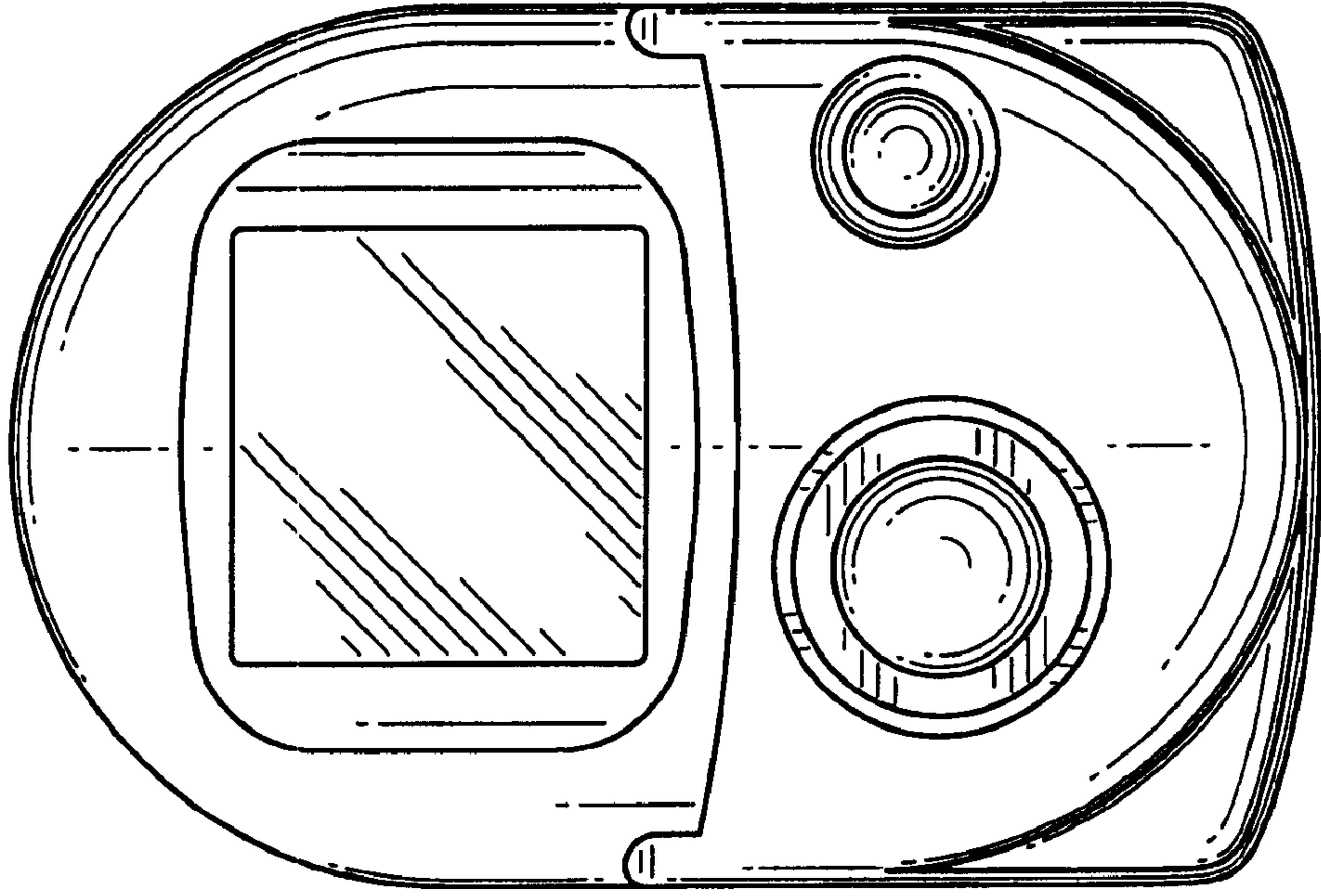

FIG. 4

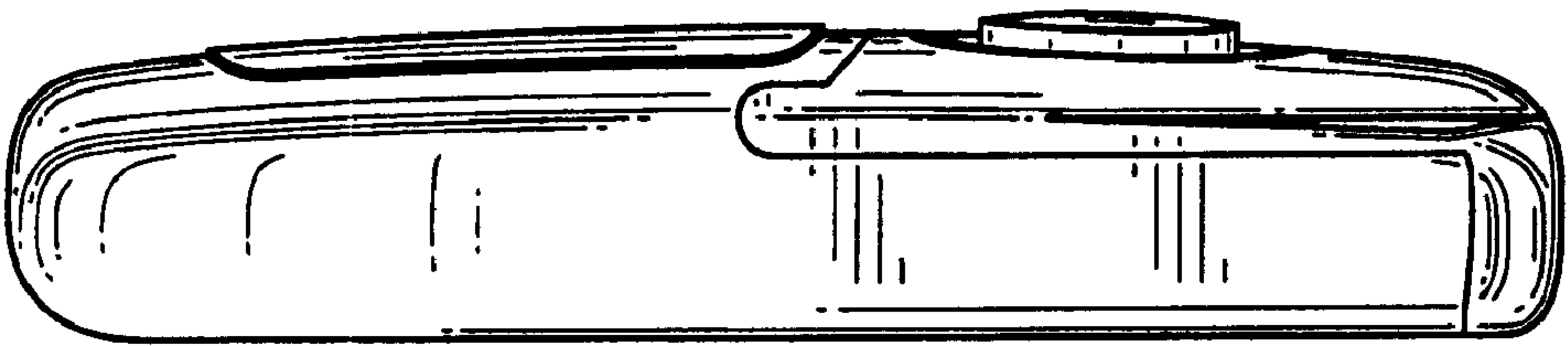

FIG. 3

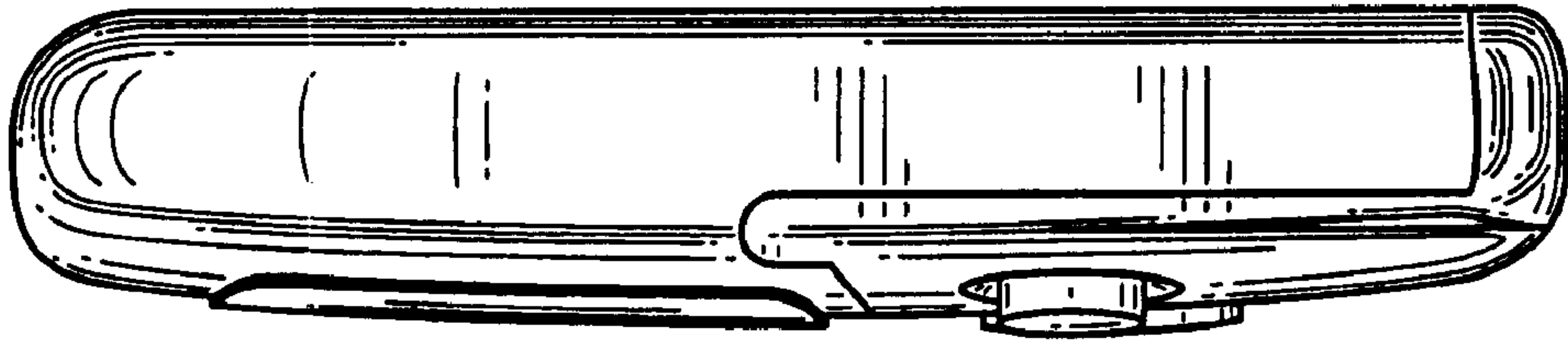

FIG. 6



FIG. 5

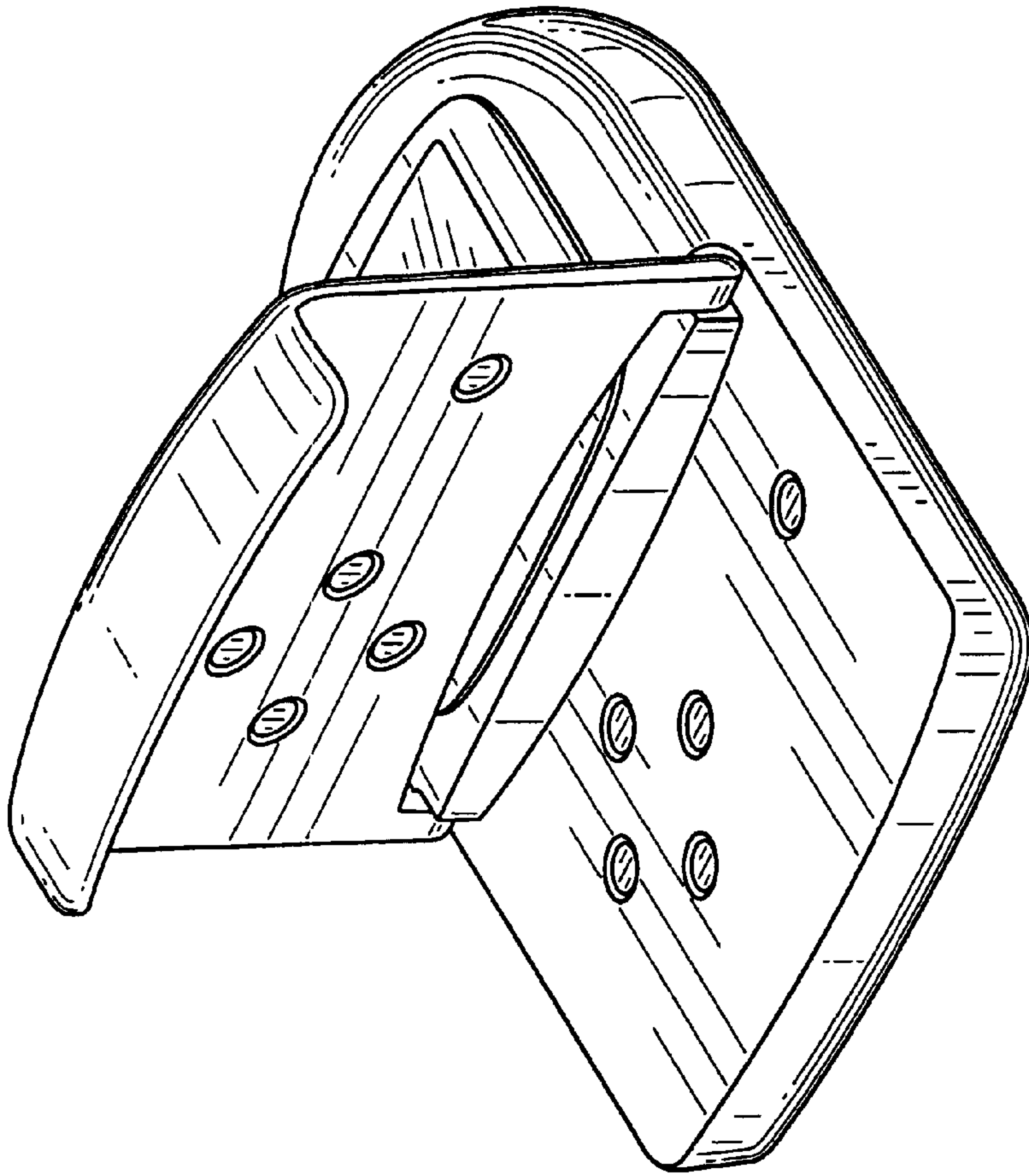

FIG. 8

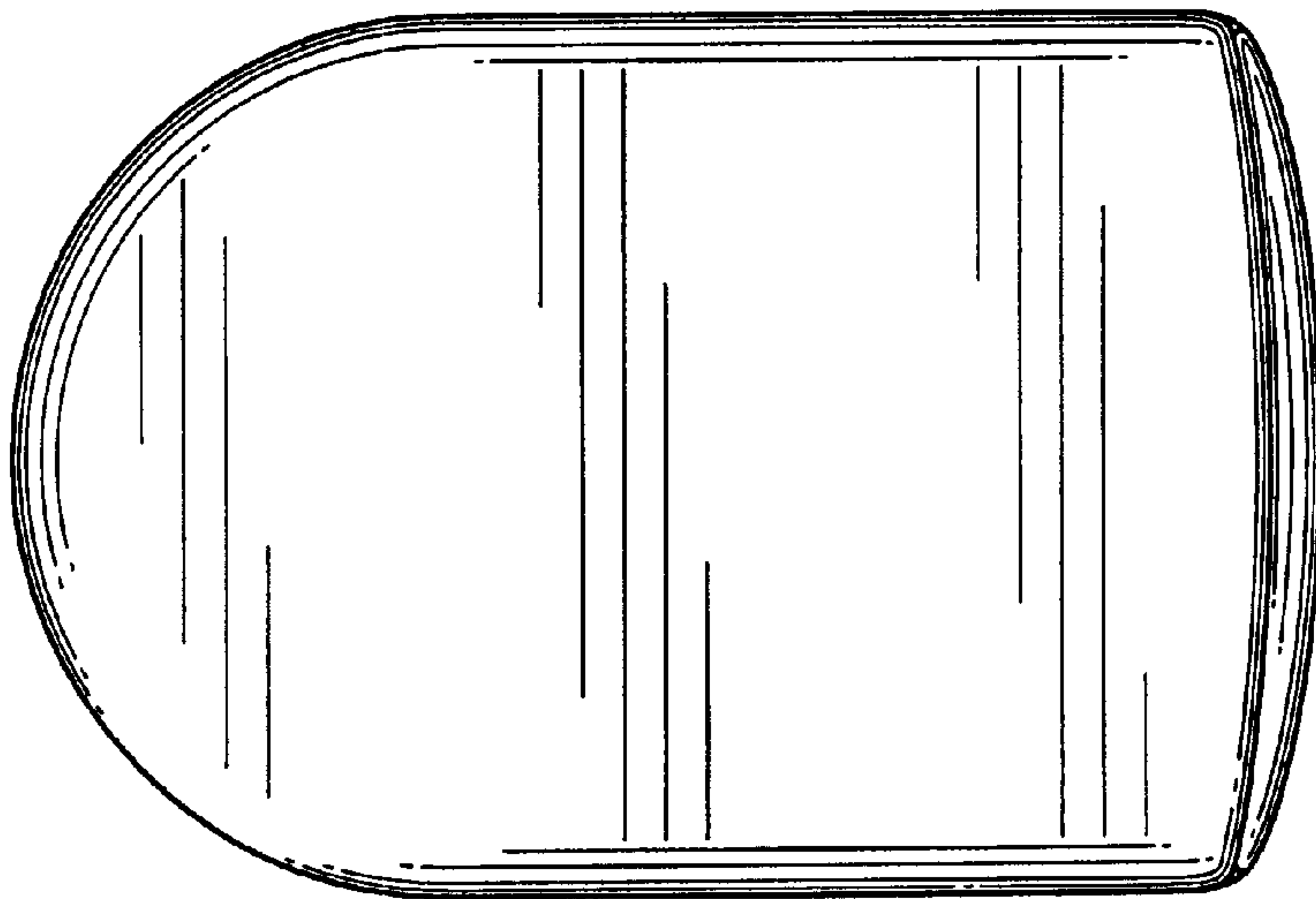

FIG. 7

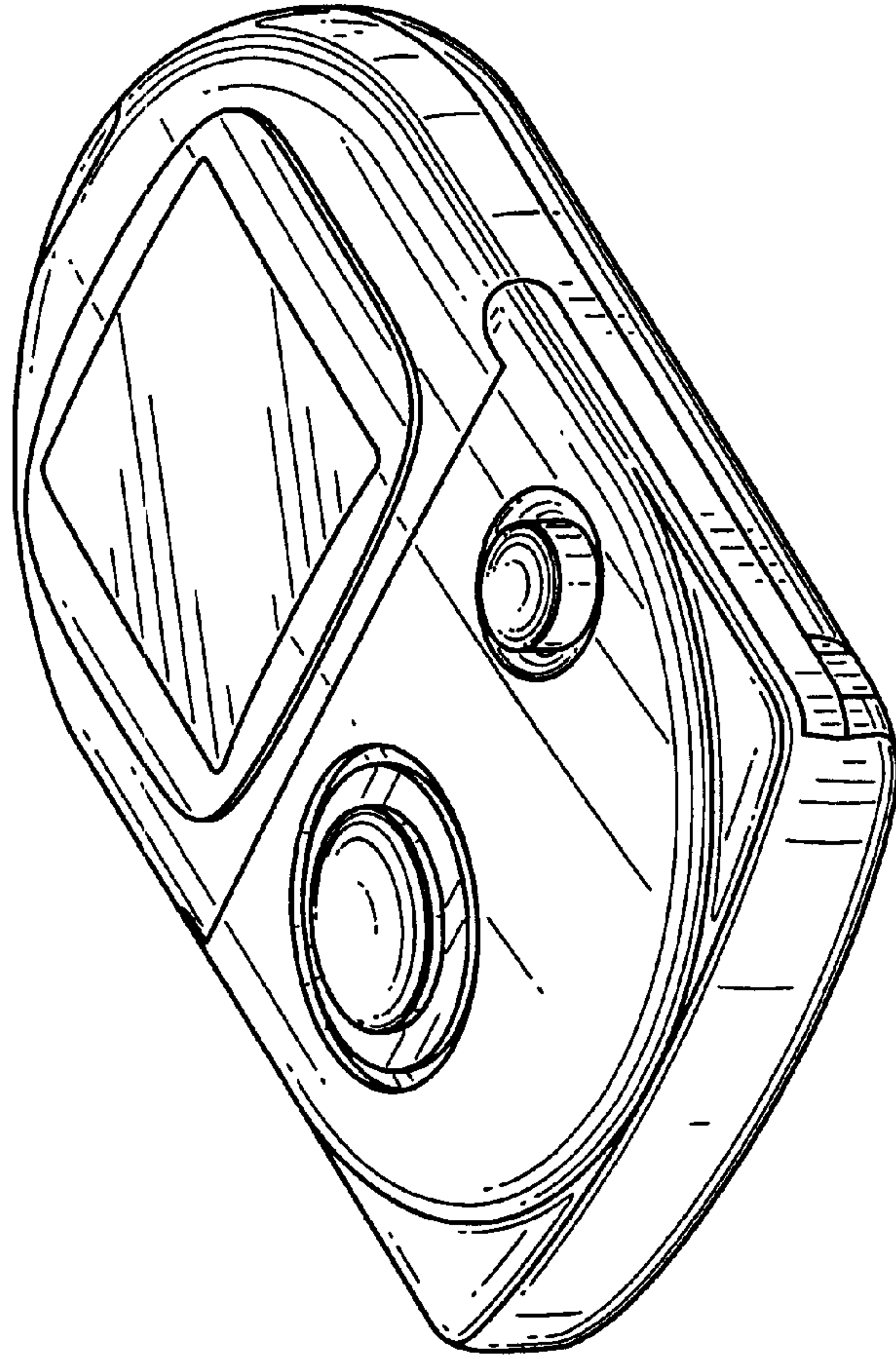

FIG. 9

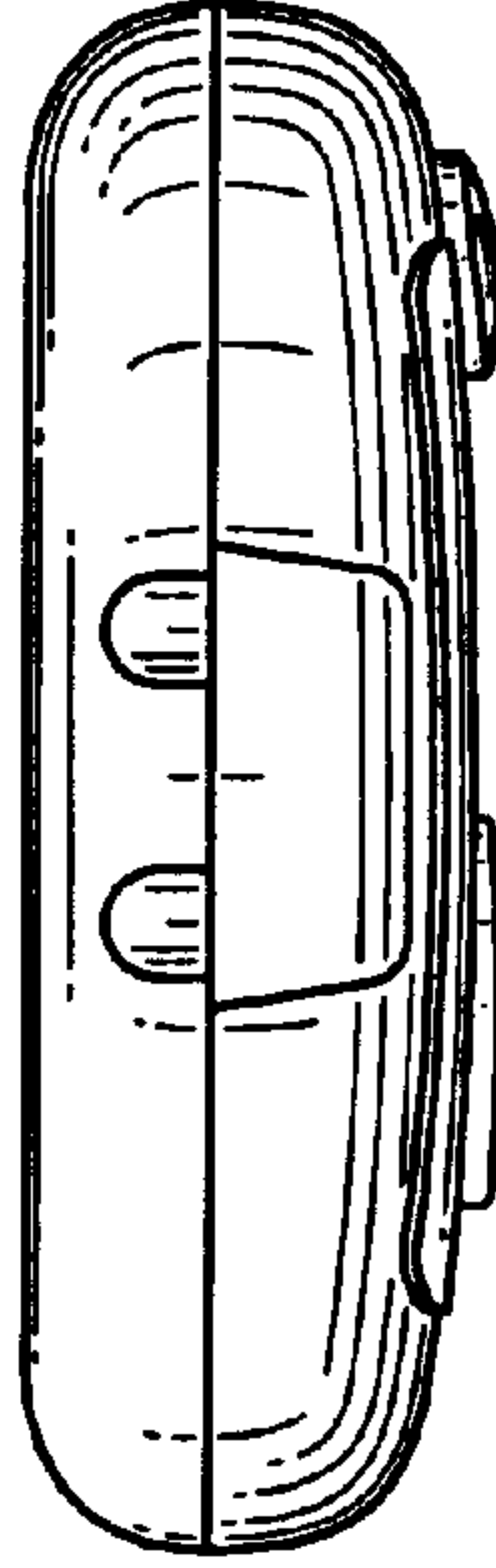

FIG. 10

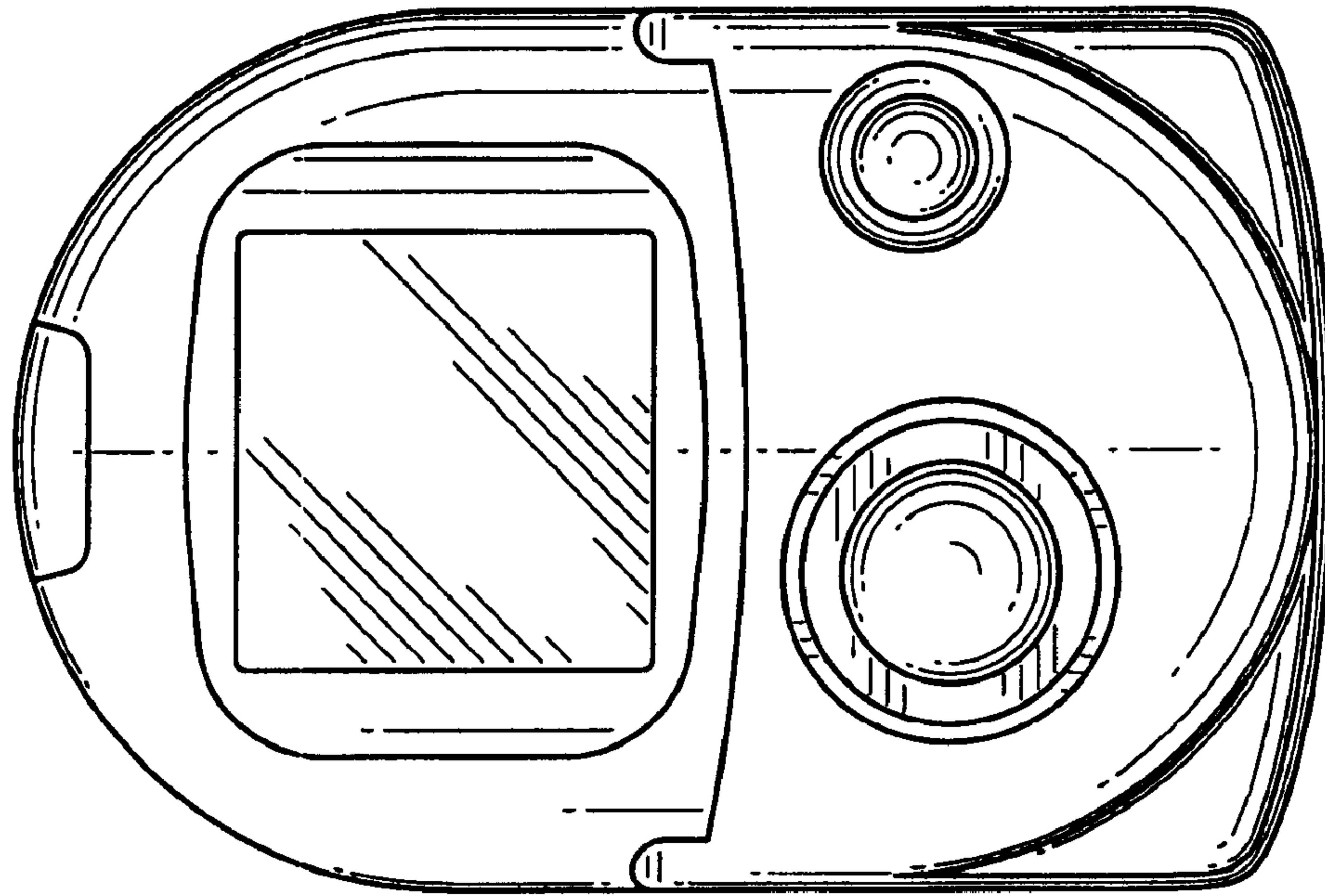

FIG. 12

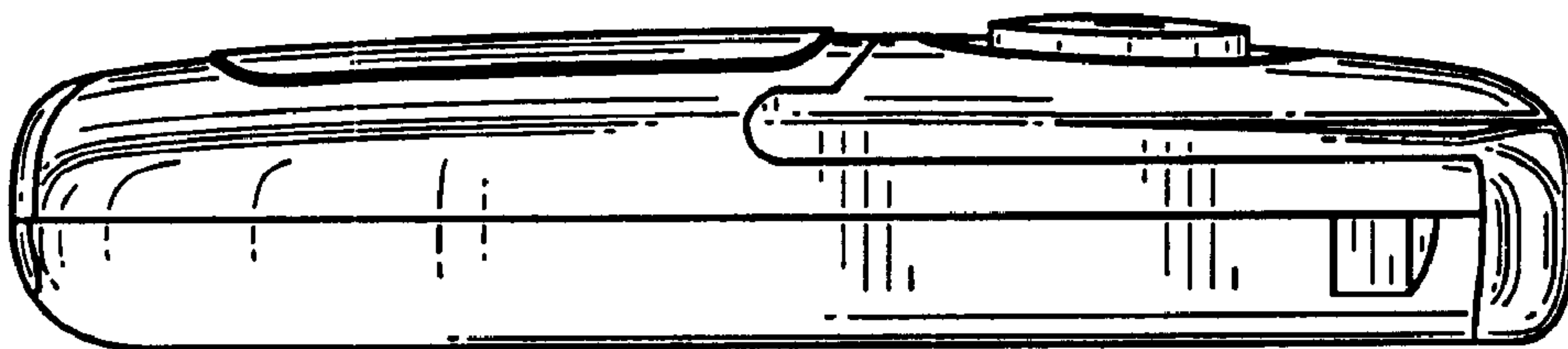

FIG. 11

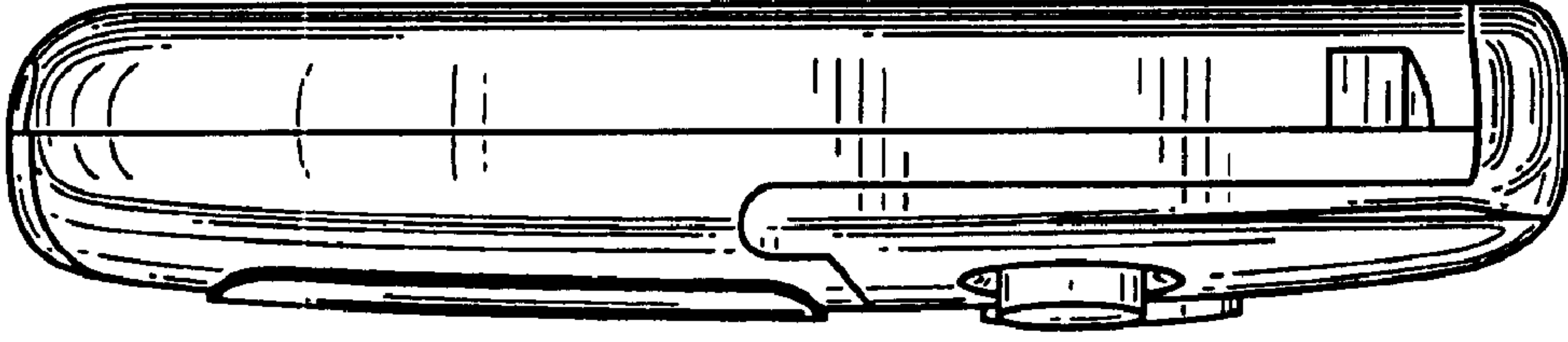

FIG. 14

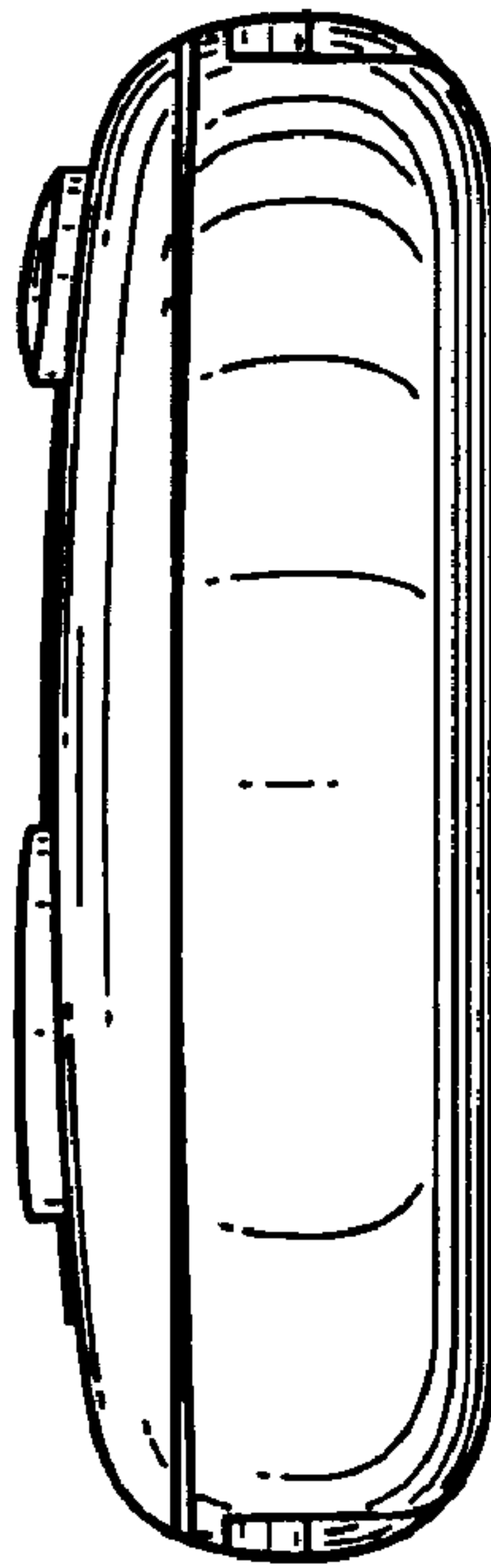

FIG. 13

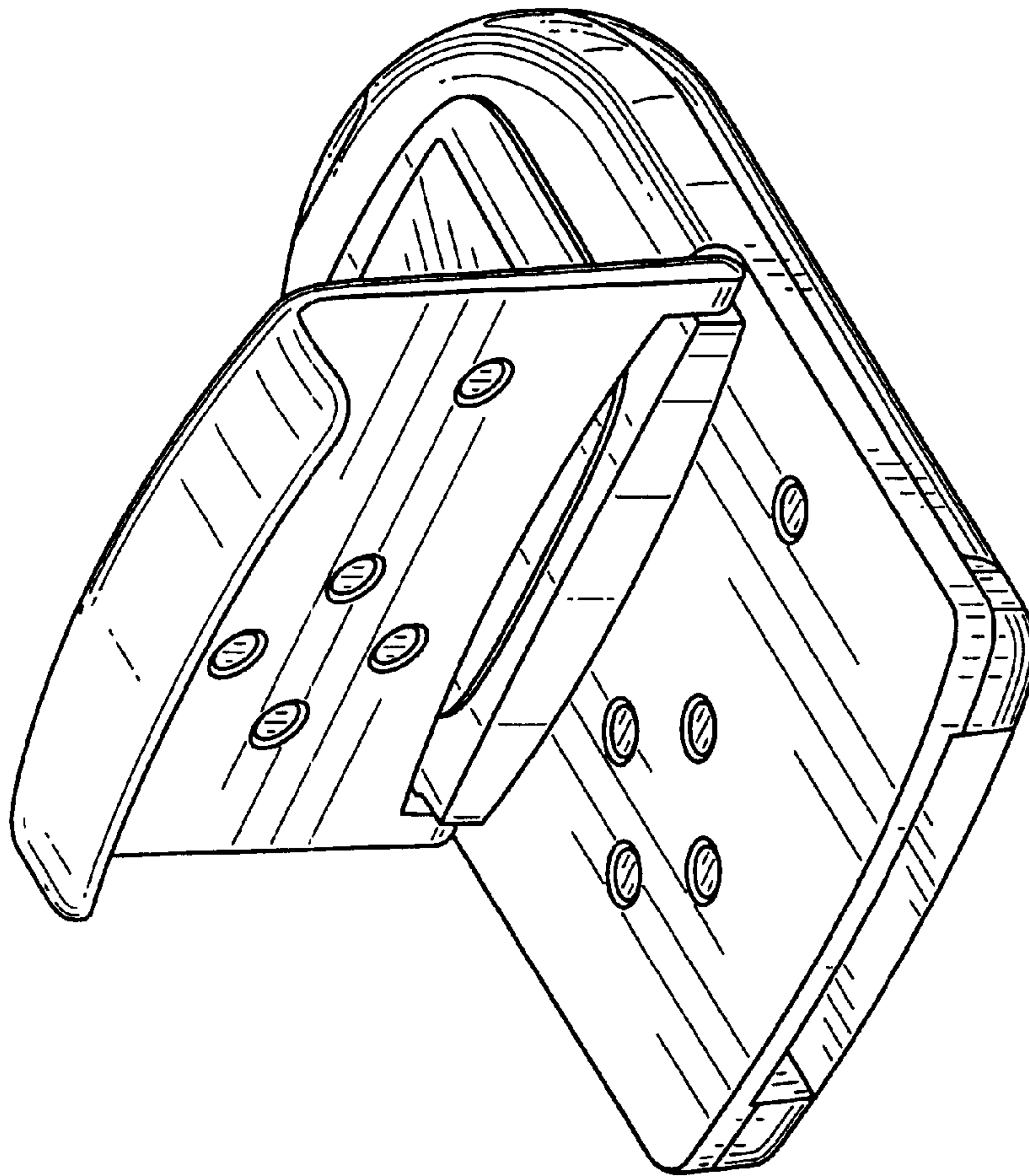

FIG. 16

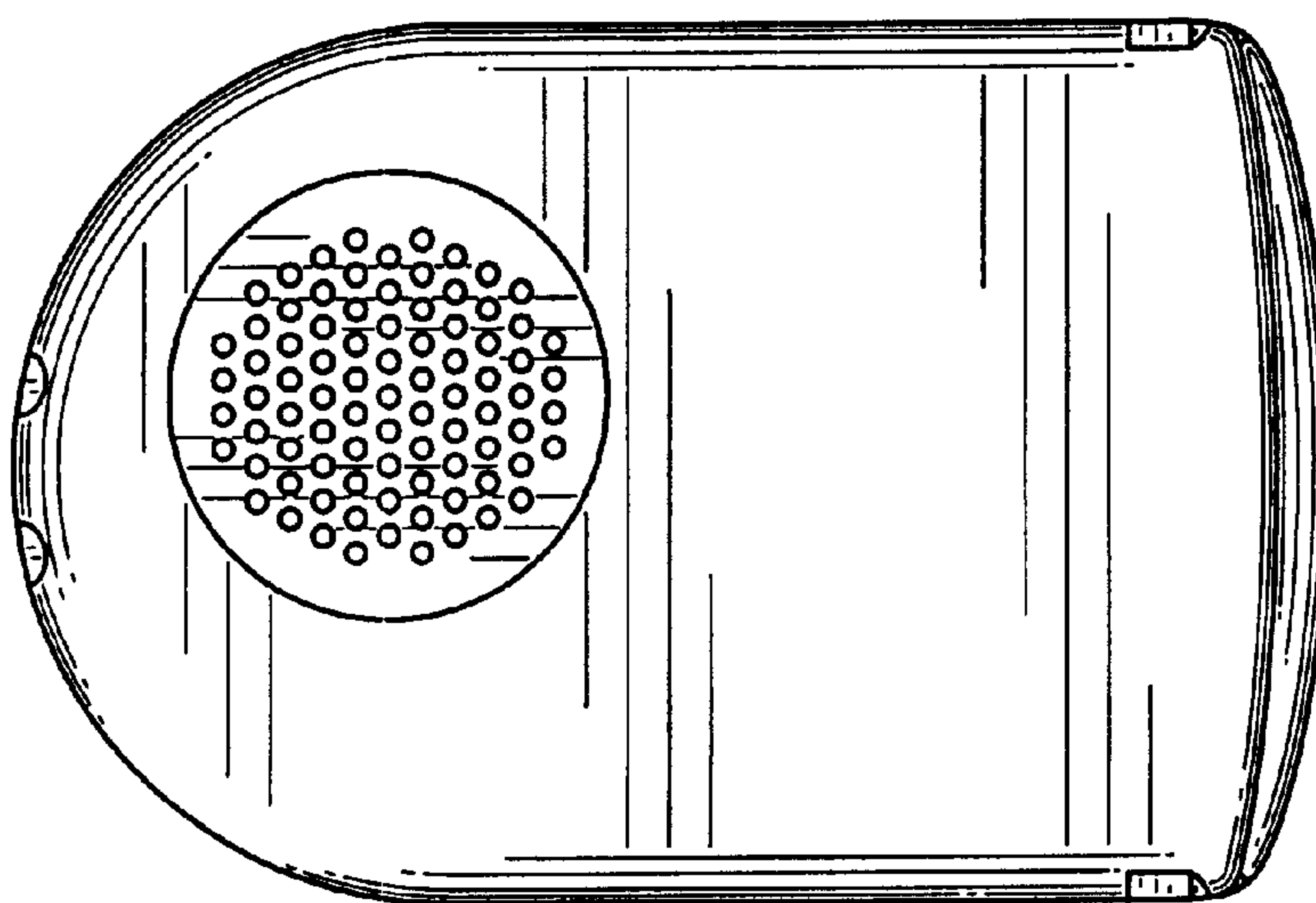

FIG. 15