



US00D433448S

**United States Patent** [19]  
**Rosenbaum**

[11] **Patent Number: Des. 433,448**  
[45] **Date of Patent: \*\* Nov. 7, 2000**

[54] **WRITING INSTRUMENT WITH BULBOUS GRIP**

[75] Inventor: **Barry Rosenbaum**, West Bloomfield, Mich.

[73] Assignee: **Advance Watch Company, Ltd.**, Warren, Mich.

[\*\*] Term: **14 Years**

[21] Appl. No.: **29/109,920**

[22] Filed: **Aug. 24, 1999**

[51] **LOC (7) Cl.** ..... **19-06**

[52] **U.S. Cl.** ..... **D19/51; D19/55; D19/56; D19/57**

[58] **Field of Search** ..... D19/35, 36, 41-51, D19/53-58, 81-85; 401/6, 7, 88, 99, 100, 110-116, 209, 243-247, 202, 262

[56] **References Cited**

**U.S. PATENT DOCUMENTS**

- D. 64,772 5/1924 Swanberg .
- D. 82,821 12/1930 Furedy .
- D. 89,339 2/1933 Hale .
- D. 92,534 6/1934 Hale .
- D. 100,845 8/1936 Bloser .
- 111,287 1/1871 Wendell .
- D. 146,025 12/1946 Harris .
- D. 150,320 7/1948 Starr ..... D19/51
- D. 160,309 10/1950 Fainberg et al. .
- D. 162,522 3/1951 Currence et al. .
- D. 175,864 10/1955 Steinberg et al. .
- D. 178,632 9/1956 Bloser .
- D. 181,180 10/1957 Bloser .
- D. 191,432 10/1961 Chapman ..... D19/51
- D. 227,037 5/1973 Bajusz .
- D. 240,817 8/1976 Funahashi .
- 255,961 4/1882 Faber .
- D. 259,727 6/1981 Zierhut .
- D. 265,212 6/1982 Spiegel .
- D. 269,445 6/1983 Kruckel et al. .
- D. 300,229 3/1989 Lee .
- D. 307,444 4/1990 Poisson et al. .
- D. 314,978 2/1991 Oka .
- D. 316,427 4/1991 Tinz .
- D. 319,662 9/1991 Henry .

- D. 321,009 10/1991 Yubisui .
- D. 324,067 2/1992 Katami ..... D19/48
- D. 338,915 8/1993 Willat .
- D. 355,441 2/1995 Rosenbaum ..... D19/51
- 412,479 10/1889 Davis .
- D. 418,873 1/2000 Shen ..... D19/51
- 544,990 8/1895 Miller .
- 614,630 11/1898 Stewart .
- 624,853 5/1899 Oberbeck .
- 770,363 9/1904 Goldsmith .
- 782,388 2/1905 Goldsmith .
- 839,537 12/1906 Beaumel .
- 1,459,517 6/1923 Sawyer .
- 1,868,441 7/1932 Colfelt .
- 1,938,835 12/1933 Grzyb .
- 2,147,561 2/1939 Sherlock ..... D19/51 X
- 2,236,194 3/1941 Lorber .
- 2,266,942 12/1941 Wallace .
- 2,845,047 7/1958 McKendree .
- 2,956,547 10/1960 Hovey, Jr. .
- 4,035,089 7/1977 Schwartz et al. .
- 4,167,347 9/1979 Hoyle .
- 4,601,598 7/1986 Schwartz et al. .
- 4,932,800 6/1990 Lin et al. .
- 5,000,599 3/1991 McCall et al. .

*Primary Examiner*—Martie K. Holtje  
*Attorney, Agent, or Firm*—Brooks & Kushman, P.C.

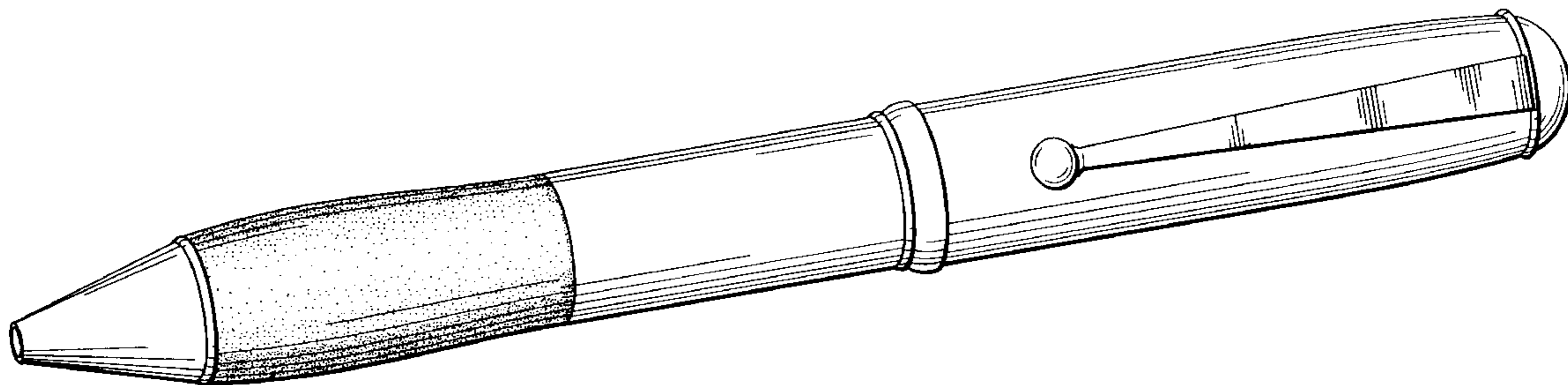
[57] **CLAIM**

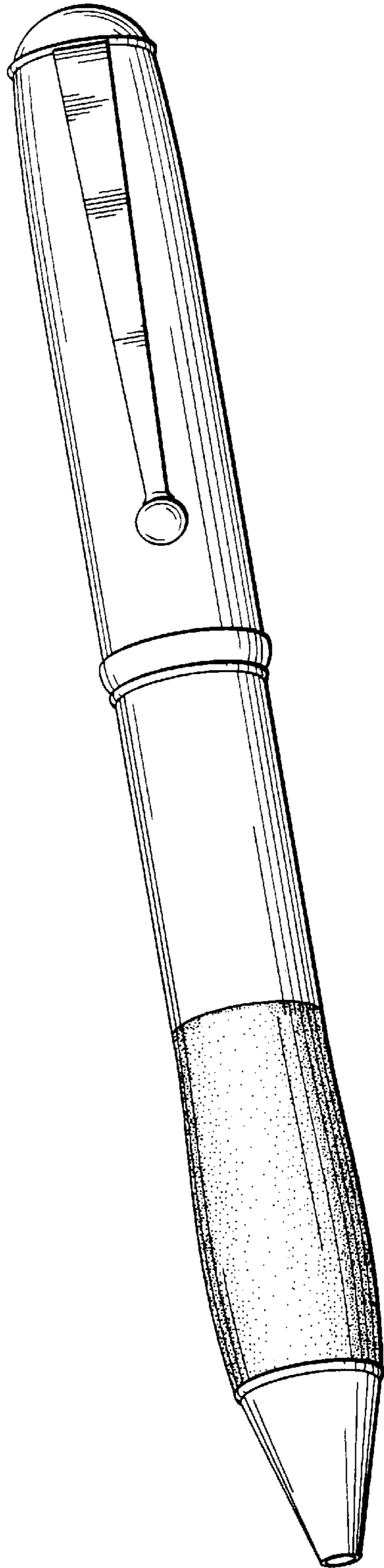
The ornamental design for a writing instrument with bulbous grip, as shown and described.

**DESCRIPTION**

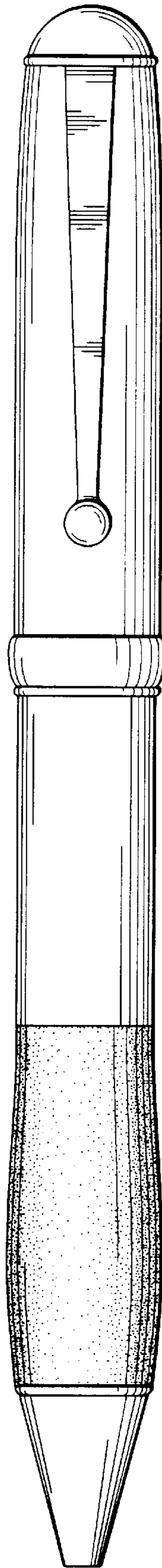
FIG. 1 is a front perspective view of the writing instrument of this invention;  
FIG. 2 is a front elevational view of the writing instrument of this invention;  
FIG. 3 is a side elevational view of the writing instrument of this invention;  
FIG. 4 is a rear elevational view of the writing instrument of this invention;  
FIG. 5 is a bottom plan view of the writing instrument of this invention; and,  
FIG. 6 is a top plan view of the writing instrument of this invention.

**1 Claim, 2 Drawing Sheets**

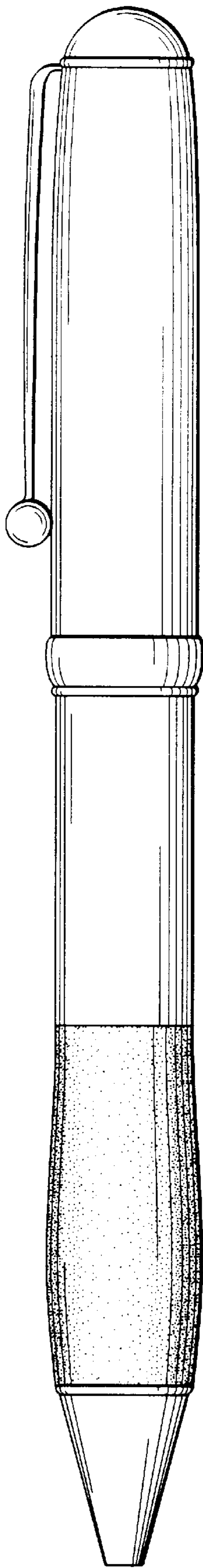




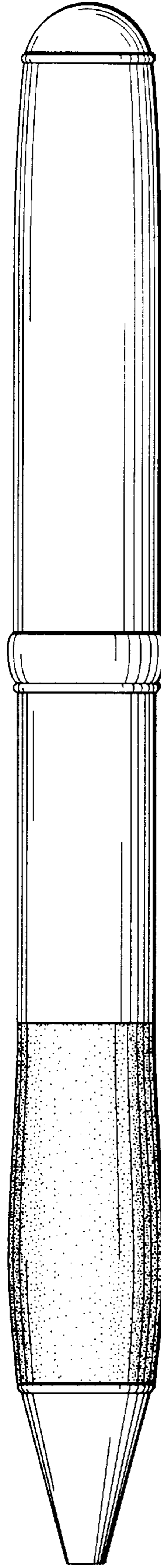
*Fig. 1*



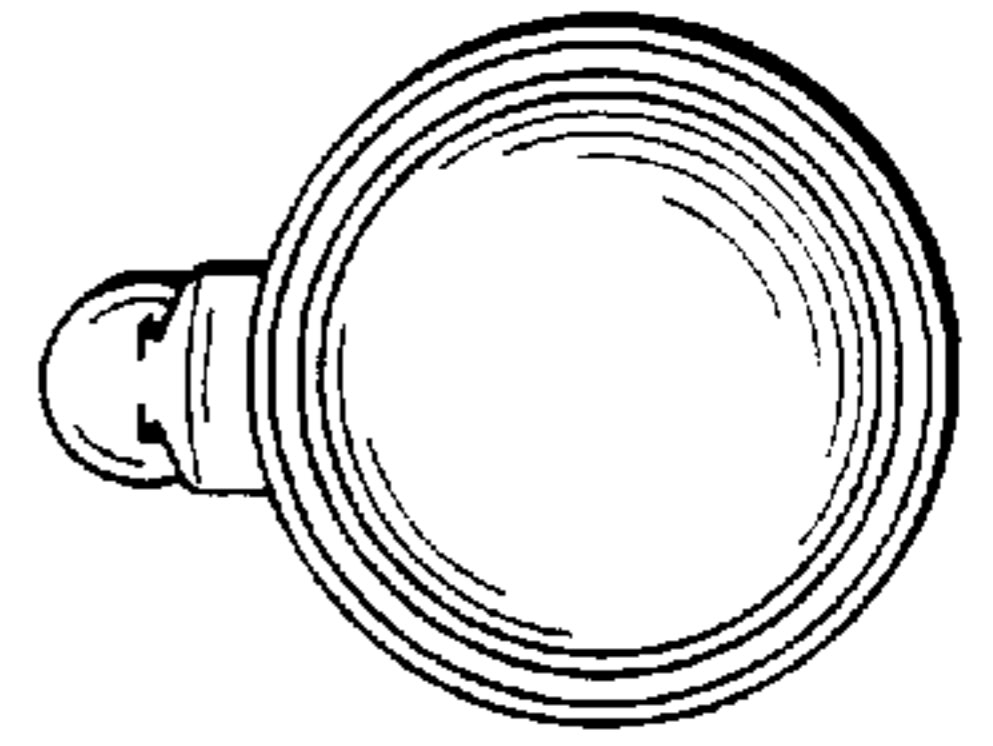
*Fig. 2*



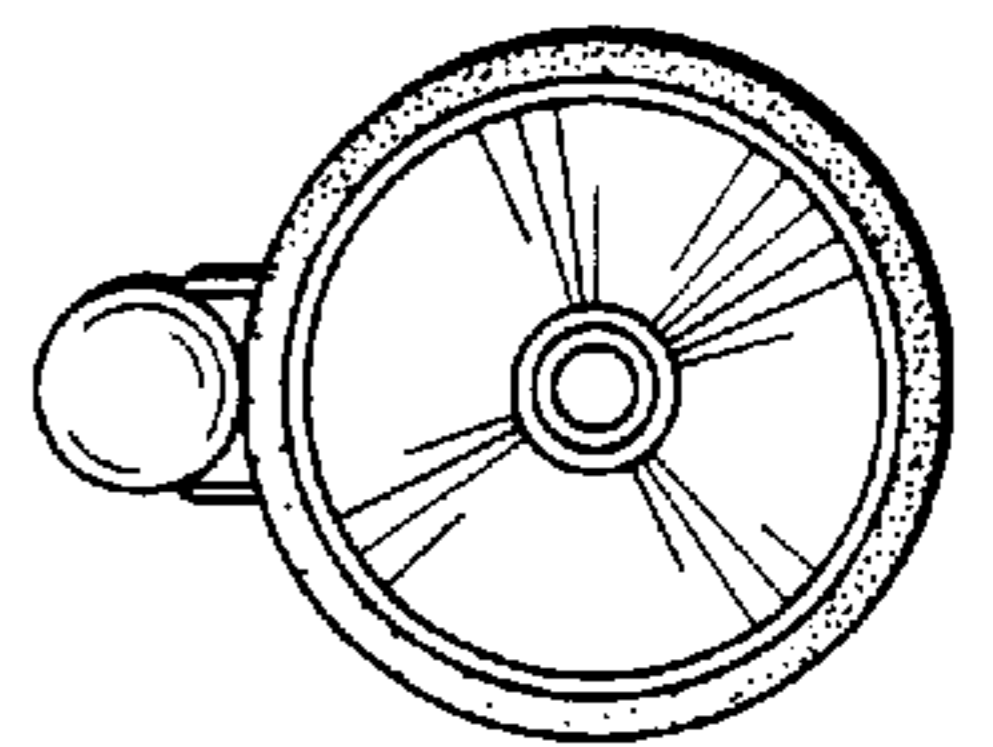
*Fig. 3*



*Fig. 4*



*Fig. 6*



*Fig. 5*