



US00D433440S

United States Patent [19]

[11] **Patent Number: Des. 433,440**

Takenouchi et al.

[45] **Date of Patent: ** Nov. 7, 2000**

[54] **ELECTRONIC COPYING MACHINE**

D. 362,457 9/1995 Shimizu D18/39
D. 384,692 10/1997 Takenouchi D18/39

[75] Inventors: **Masaaki Takenouchi; Rie Takada; Hiroshi Nakada**, all of Yokohama, Japan; **William T. Clark**, Rochester, N.Y.

Primary Examiner—Caron D. Veynar
Attorney, Agent, or Firm—Oliff & Berridge, PLC

[73] Assignee: **Fuji Xerox Co., Ltd.**, Tokyo, Japan

[57] **CLAIM**

[**] Term: **14 Years**

The ornamental design for an electronic copying machine, as shown and described.

[21] Appl. No.: **29/108,764**

DESCRIPTION

[22] Filed: **Aug. 4, 1999**

[30] **Foreign Application Priority Data**

Feb. 9, 1999 [JP] Japan 11-2777

FIG. 1 is a perspective view of the top, front and left side of an electronic copying machine showing our new design;

[51] **LOC (7) Cl.** **16-03**

FIG. 2 is a front view thereof;

[52] **U.S. Cl.** **D18/39**

FIG. 3 is a top plan view thereof;

[58] **Field of Search** D18/36-39; 399/1,

FIG. 4 is a right side view thereof;

399/3, 151; 355/400

FIG. 5 is a left side view thereof;

FIG. 6 is a rear view thereof; and,

FIG. 7 is a bottom view thereof.

[56] **References Cited**

U.S. PATENT DOCUMENTS

D. 358,412 5/1995 Momose et al. D18/39

1 Claim, 7 Drawing Sheets

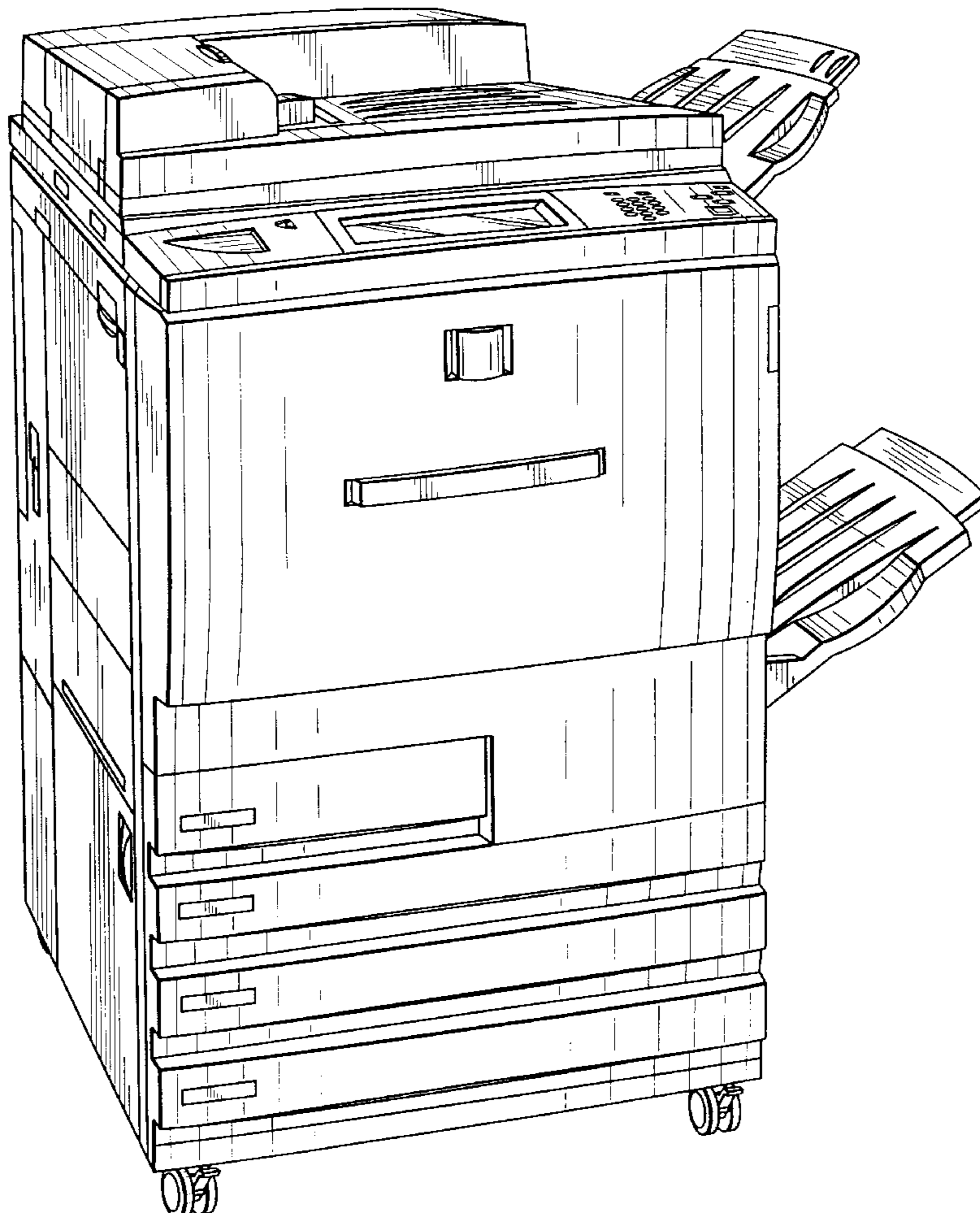

FIG. 1

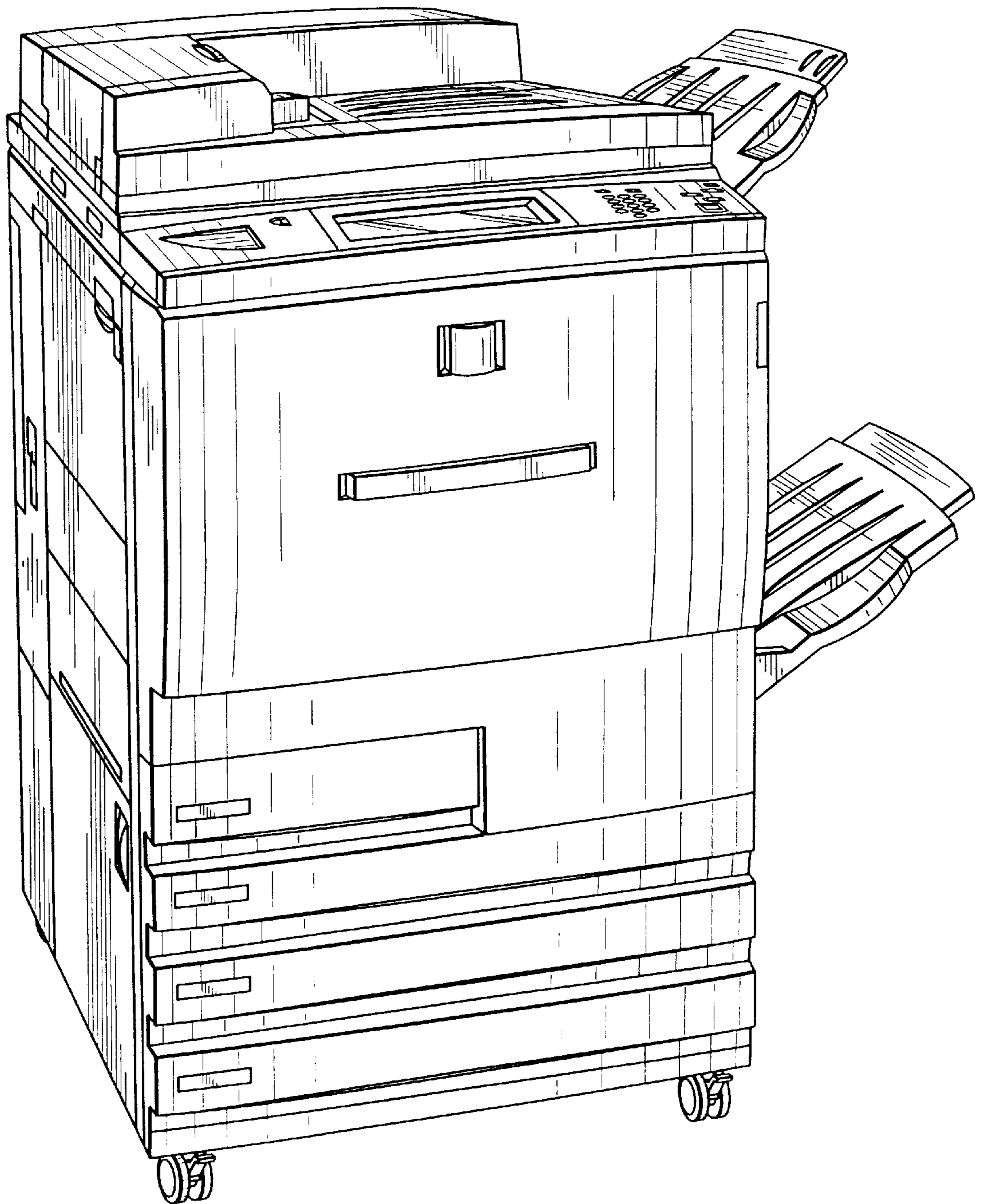

FIG. 2

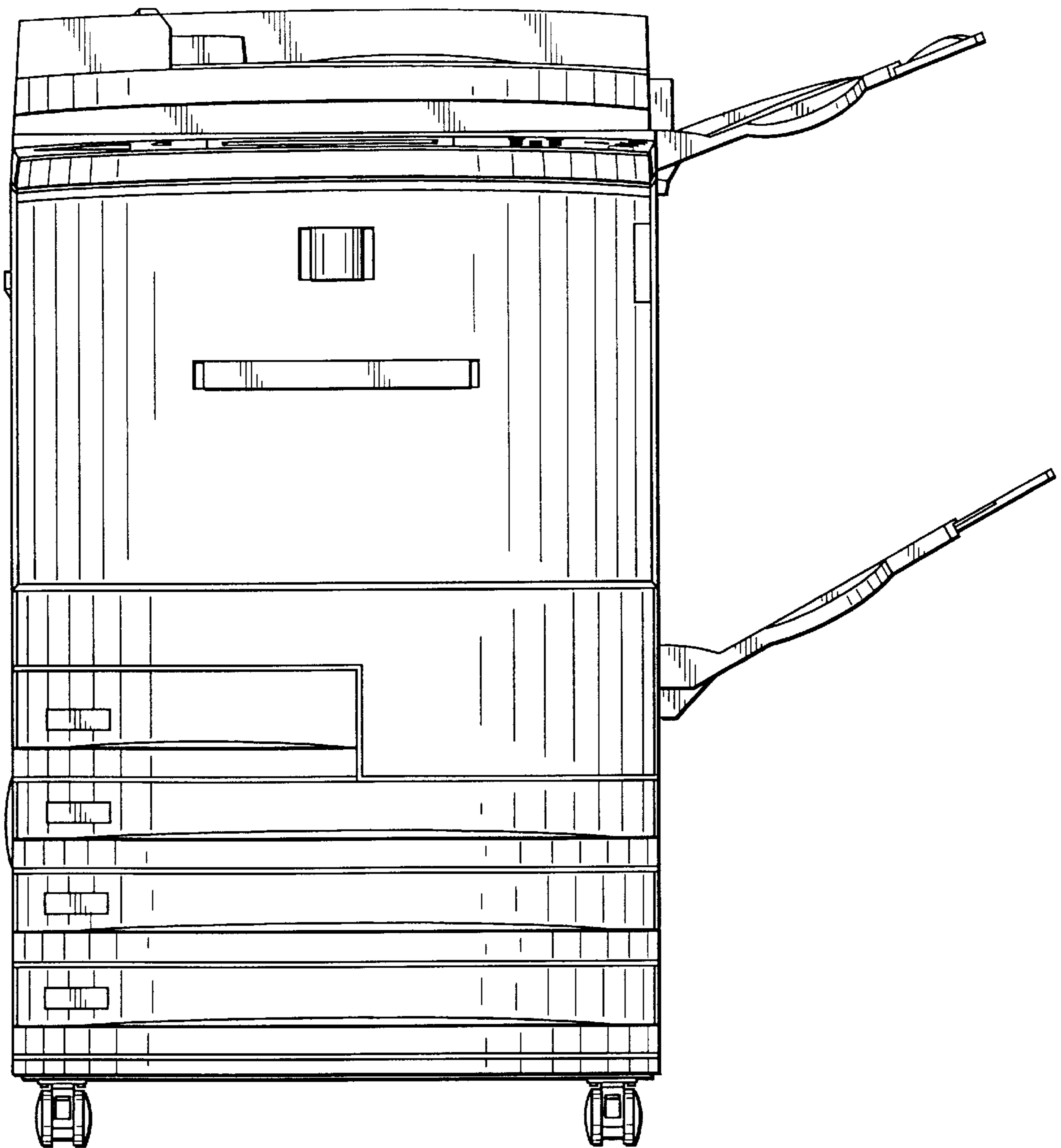

FIG. 3

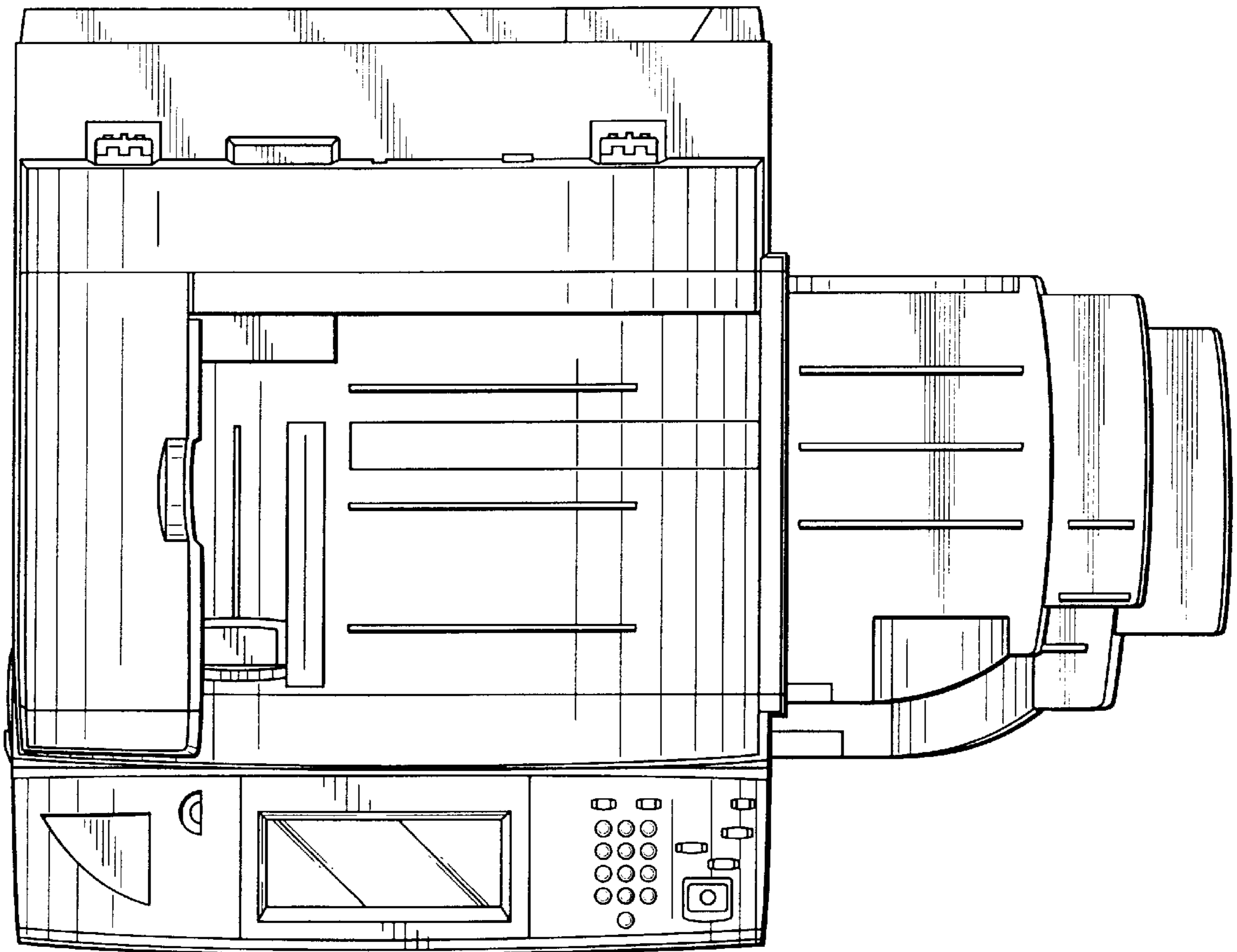

FIG. 4

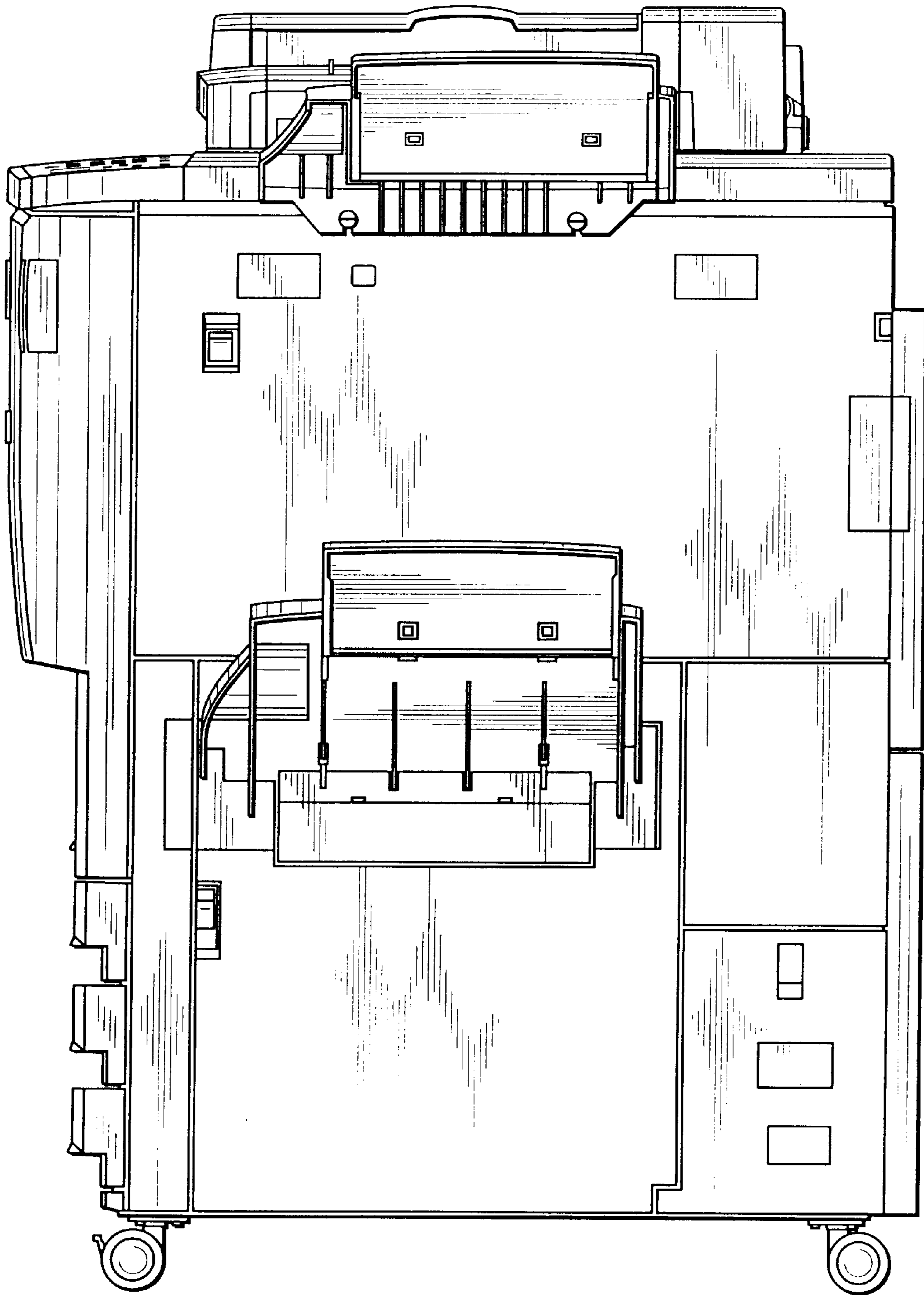

FIG. 5



FIG. 6

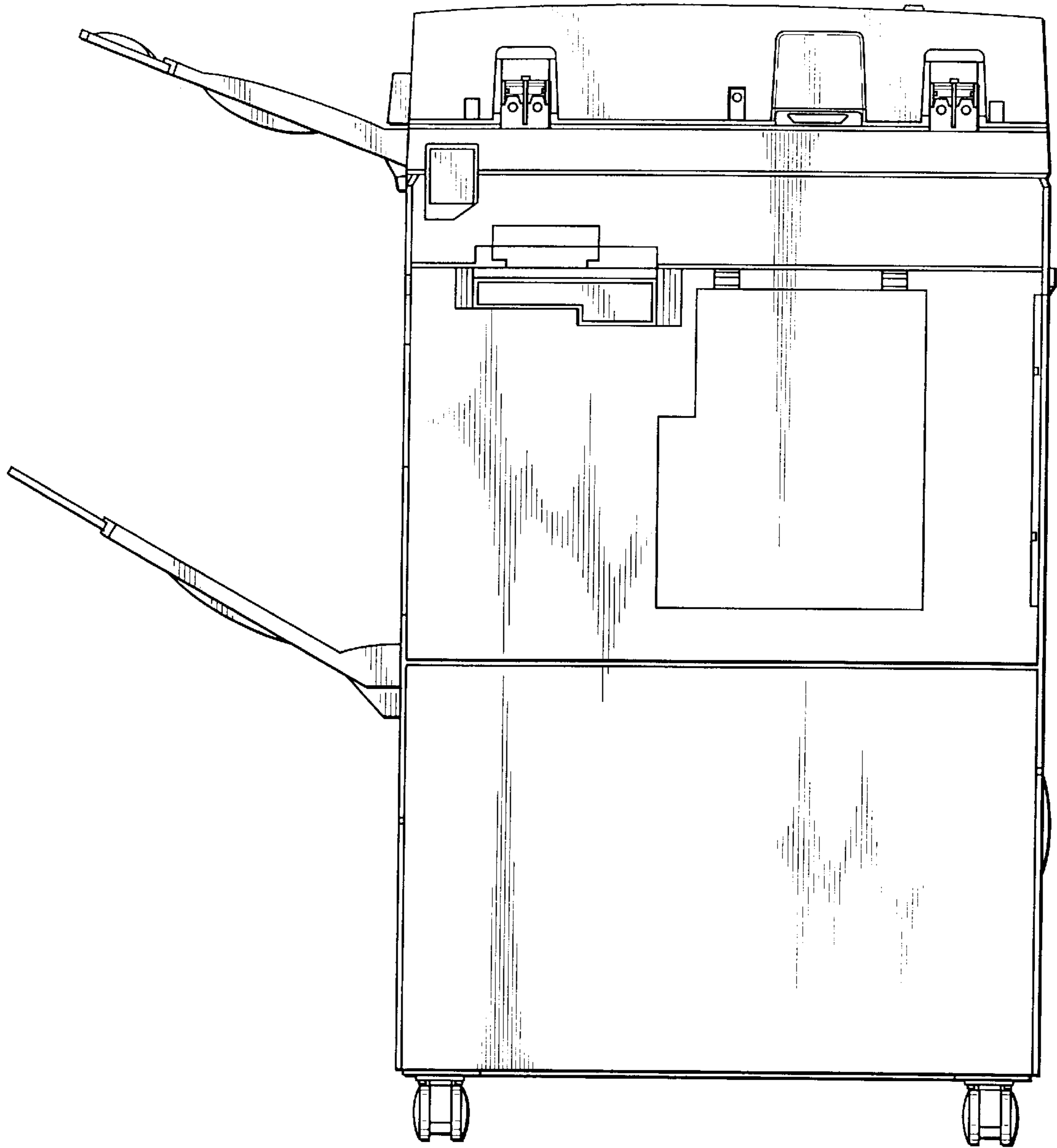

FIG. 7

