



US00D433438S

# United States Patent [19] Wharram

[11] Patent Number: Des. 433,438

[45] Date of Patent: \*\* Nov. 7, 2000

[54] RESTAURANT ORDERING UNIT

Primary Examiner—Caron D. Veynar

[76] Inventor: **Kevin G Wharram**, Suite 157, 235  
Earls Court Road, London SW5 9FE,  
United Kingdom

[57] CLAIM

The ornamental design for a restaurant ordering unit, as shown and described.

[\*\*] Term: 14 Years

DESCRIPTION

[21] Appl. No.: 29/120,453

FIG. 1 is a front elevational view of the restaurant ordering unit of the present invention;

[22] Filed: Mar. 17, 2000

FIG. 2 is a rear elevational view of the restaurant ordering unit of FIG. 1;

[51] LOC (7) Cl. .... 18-01

FIG. 3 is a left side elevational view of the restaurant ordering unit of FIG. 1;

[52] U.S. Cl. .... D18/4.4; D18/4.6

FIG. 4 is a right side elevational view of the restaurant ordering unit of FIG. 1;

[58] Field of Search ..... D18/2, 6, 7, 4.1,  
D18/4.3-4.6; 235/2, 7 R, 61 R; 705/15,  
16, 17; D14/346

FIG. 5 is a top plan view of the restaurant ordering unit of FIG. 1; and,

[56] References Cited

FIG. 6 is a bottom plan view of the restaurant ordering unit of FIG. 1.

### U.S. PATENT DOCUMENTS

|            |         |                |       |          |
|------------|---------|----------------|-------|----------|
| D. 362,013 | 9/1995  | Benjamin       | ..... | D18/7    |
| D. 406,271 | 3/1999  | Henriksen      | ..... | D18/7    |
| D. 410,440 | 6/1999  | Carnell        | ..... | D14/346  |
| 4,257,306  | 3/1981  | Laflamme       | ..... | 84/485 R |
| 4,875,164  | 10/1989 | Monfort        | ..... | 463/25   |
| 5,235,509  | 8/1993  | Mueller et al. | ..... | 705/15   |

The broken lines showing of letters in FIG. 1 is for illustrative purposes only and form no part of the claimed design. The electrical cord in FIGS. 3-6 shown broken away to indicate indeterminate length.

1 Claim, 5 Drawing Sheets

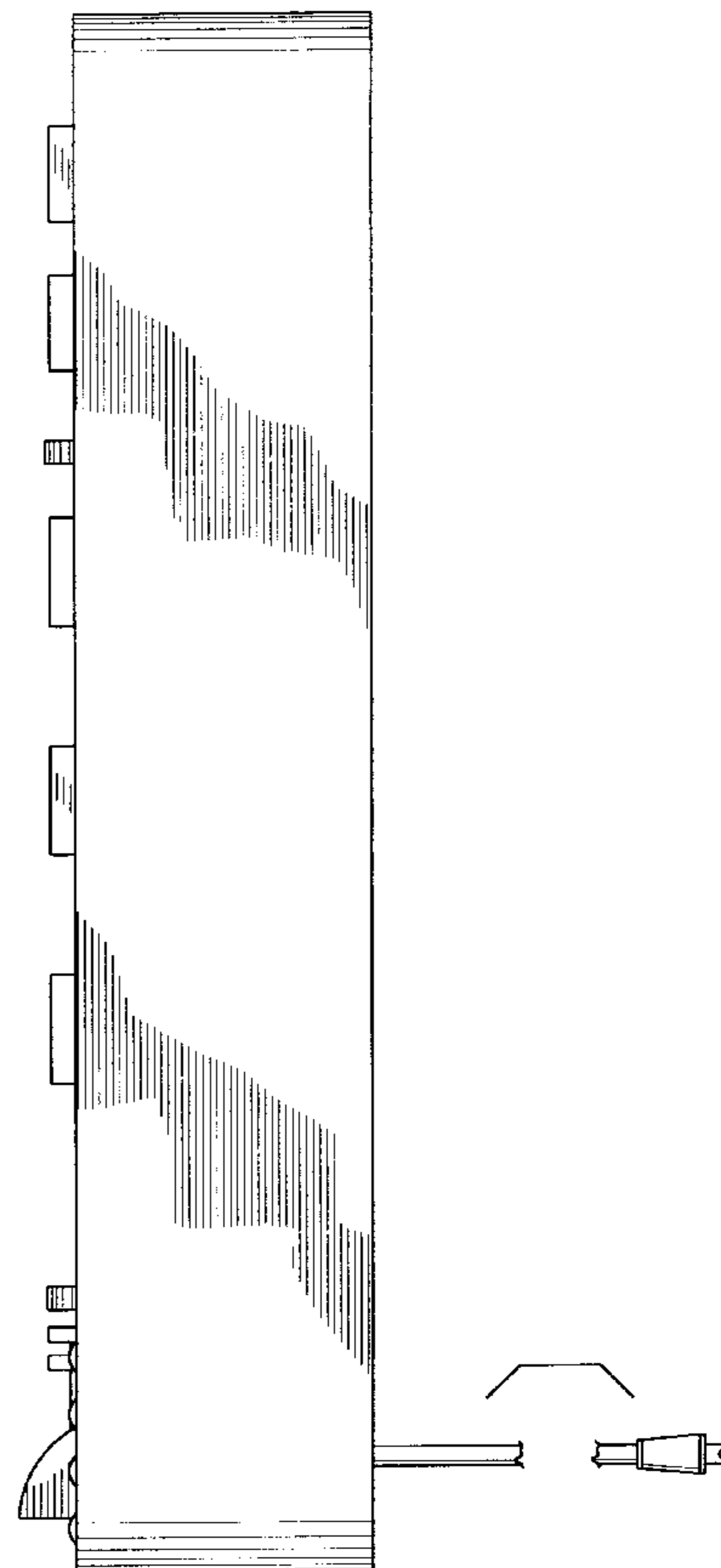
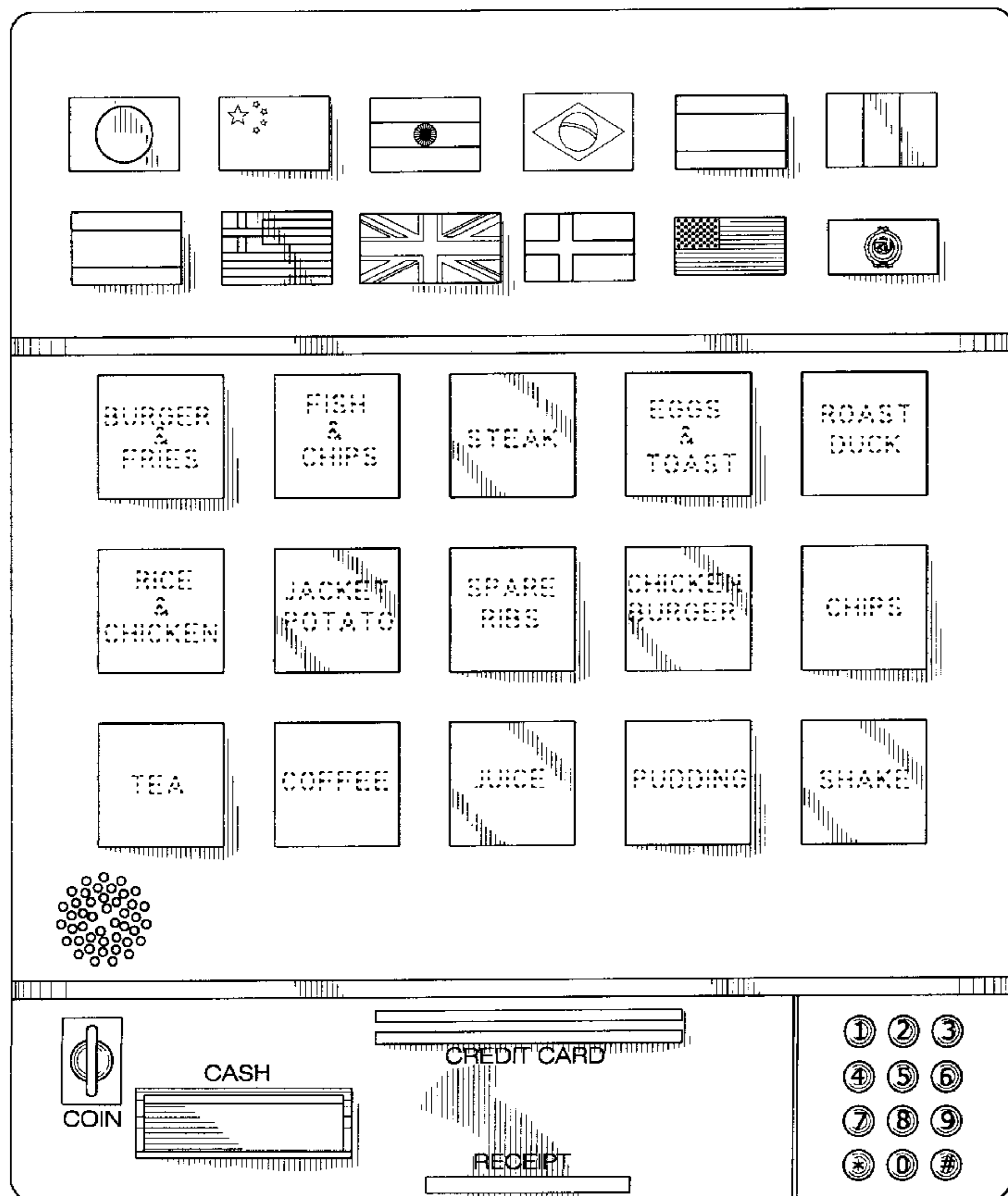

FIG. 1

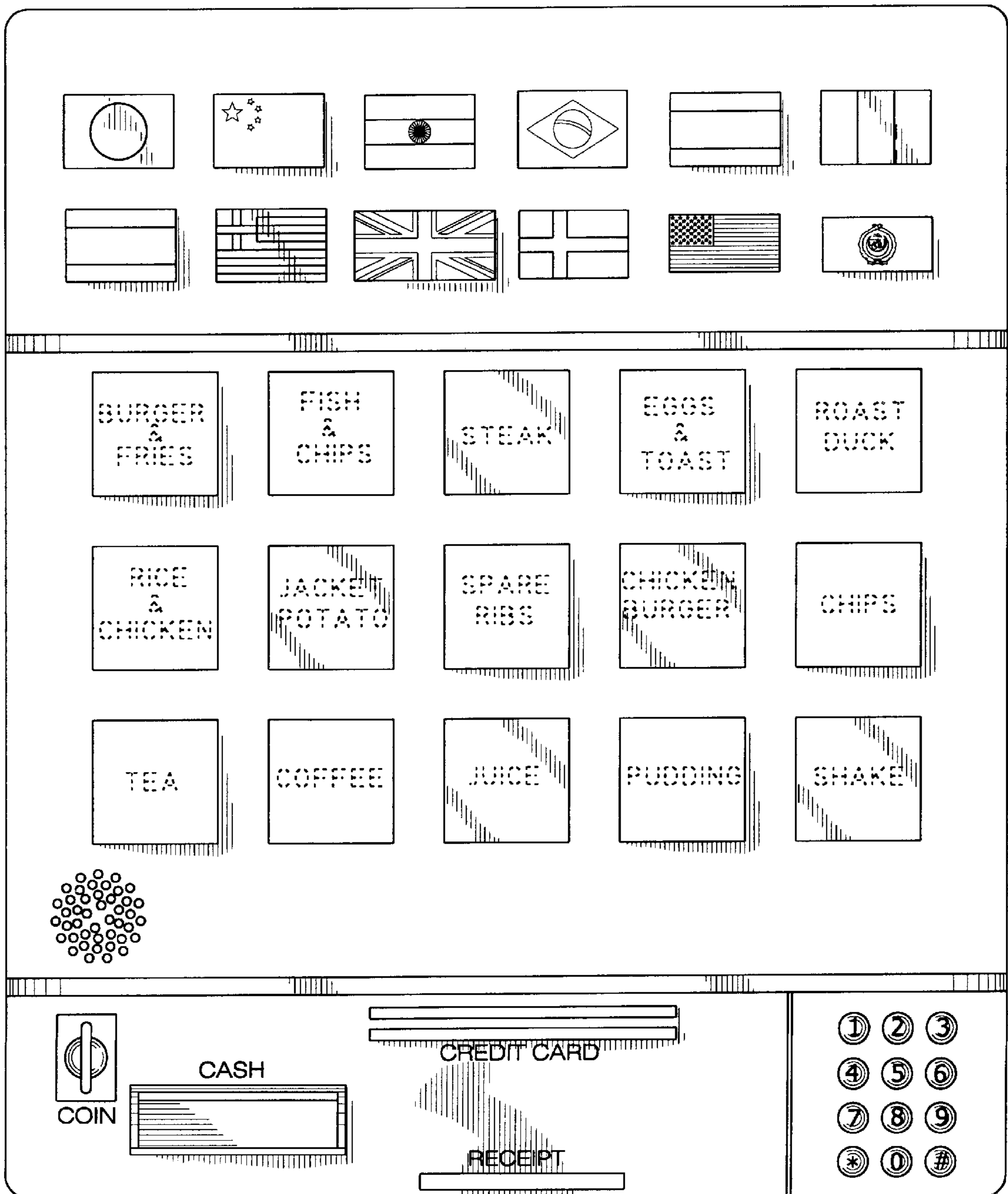

FIG. 2

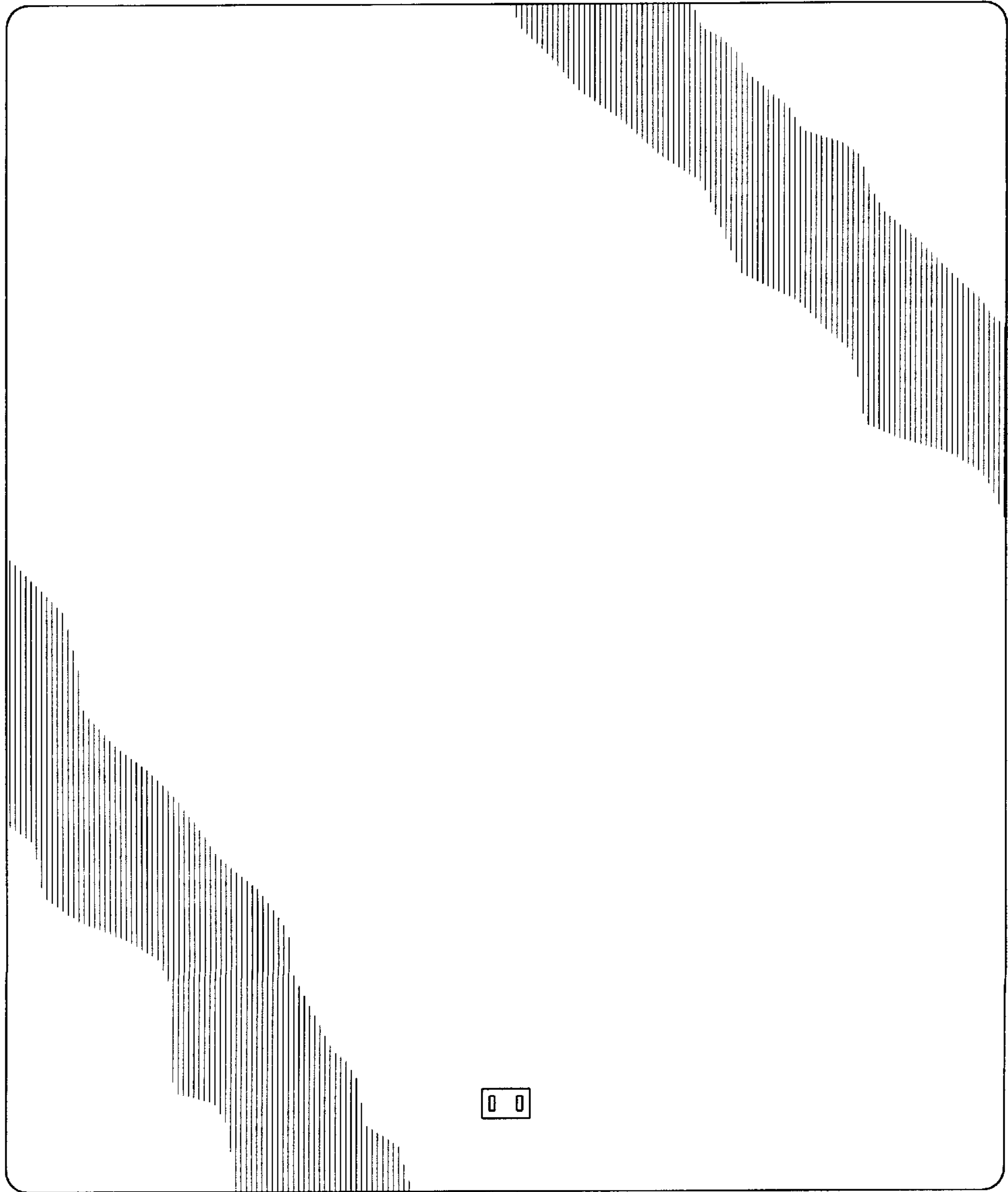
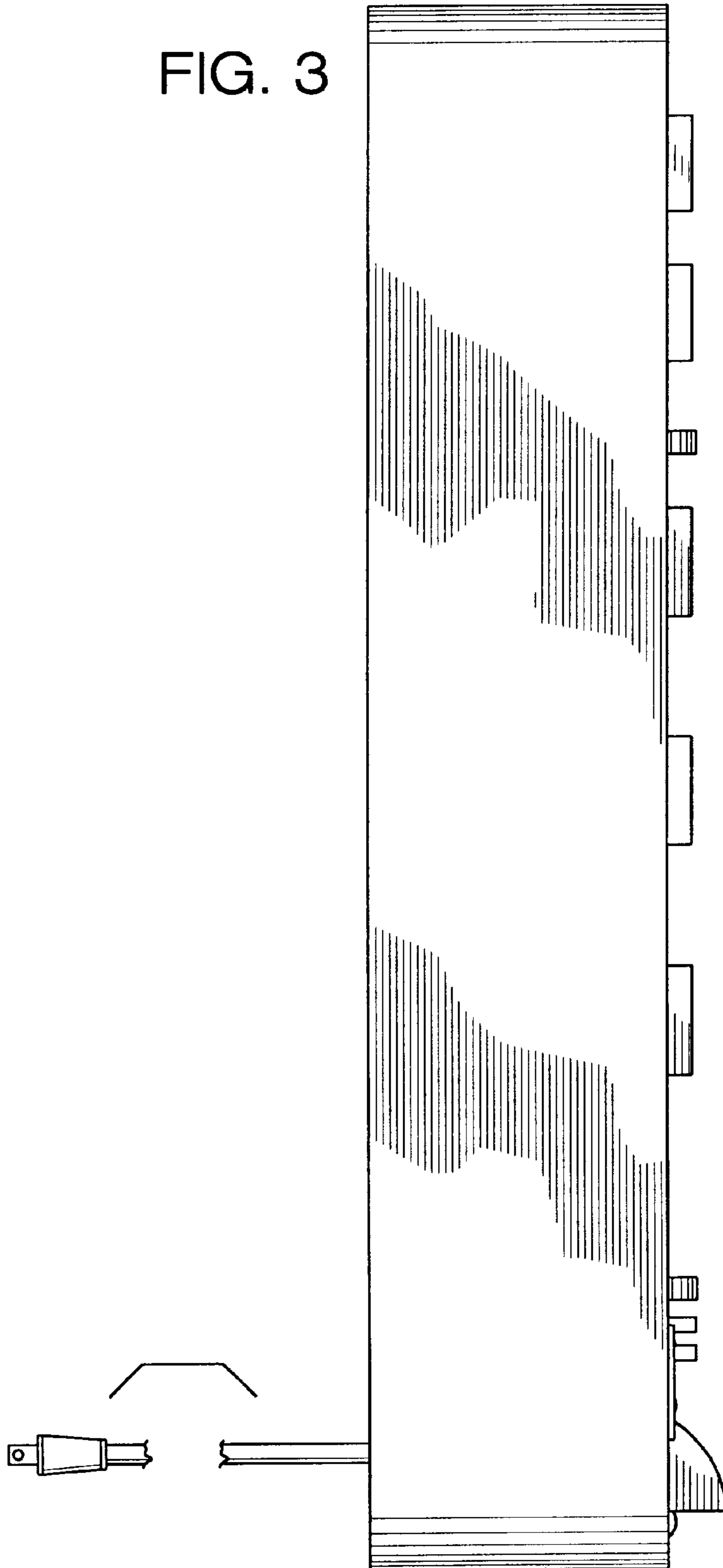

FIG. 3



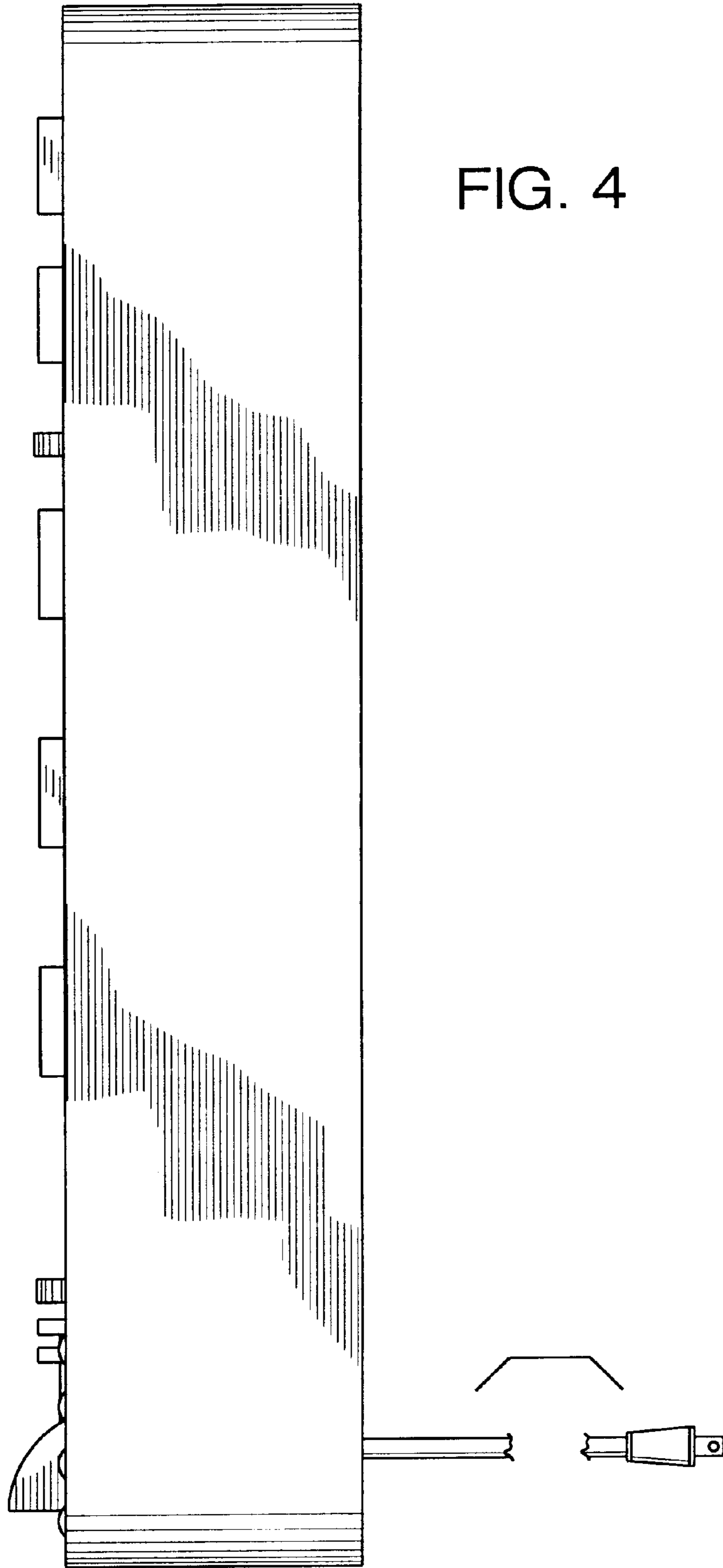

FIG. 5

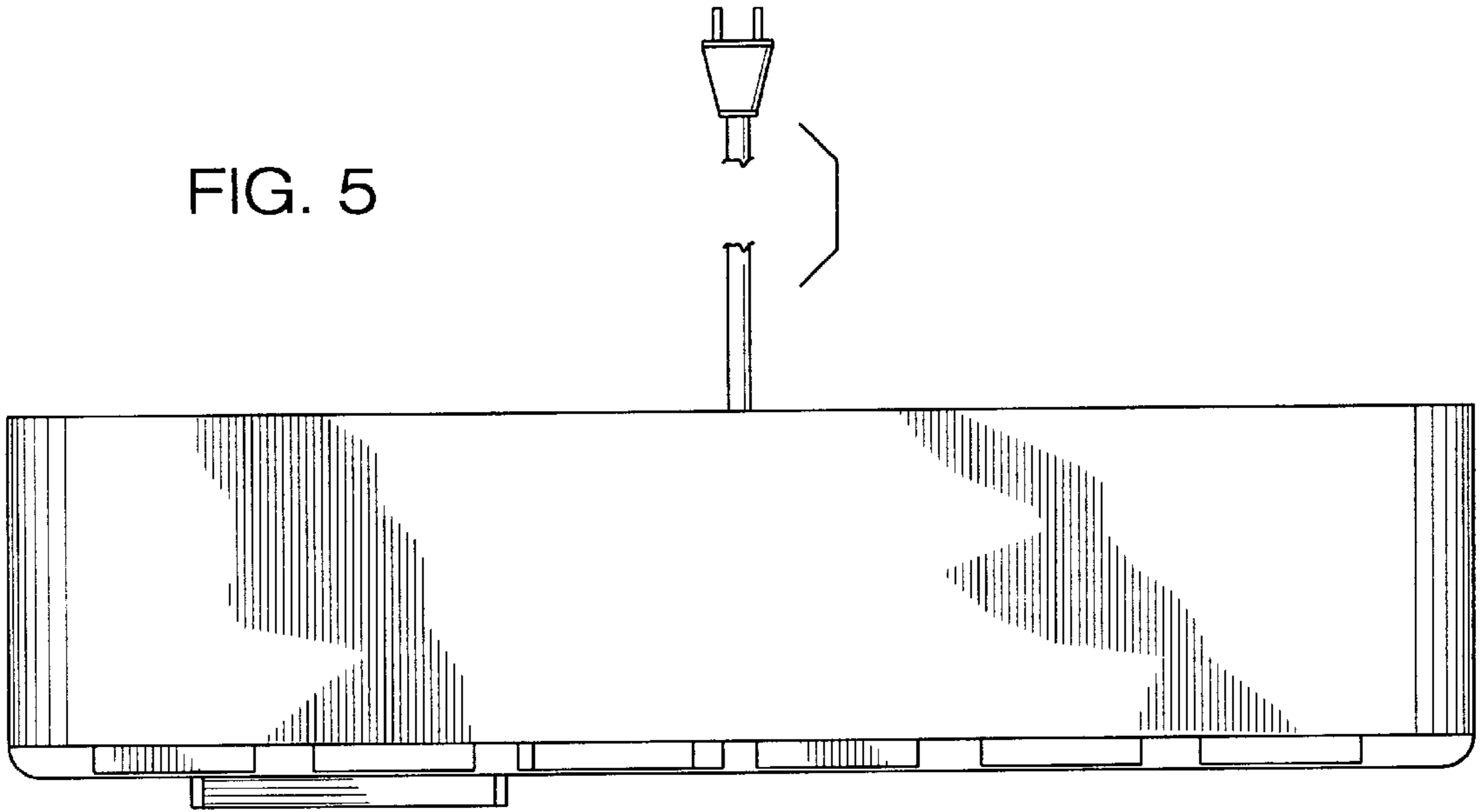

FIG. 6

