



US00D433394S

# United States Patent [19] Suzuki

[11] **Patent Number: Des. 433,394**

[45] **Date of Patent: \*\* Nov. 7, 2000**

[54] **TELEVISION MONITOR**

[75] Inventor: **Akio Suzuki**, Tokyo, Japan

[73] Assignee: **Sony Corporation**, Japan

[\*\*] Term: **14 Years**

[21] Appl. No.: **29/099,582**

[22] Filed: **Jan. 25, 1999**

[51] **LOC (7) Cl. .... 14-03**

[52] **U.S. Cl. .... D14/126**

[58] **Field of Search ..... D14/113, 126-134;  
312/7.2; 348/836, 838; 345/905**

[56] **References Cited**

**U.S. PATENT DOCUMENTS**

D. 336,644	6/1993	Thackray	.....	D14/126
D. 377,349	1/1997	Renk	.....	D14/129
5,934,772	8/1999	Sung	.....	312/7.2

**OTHER PUBLICATIONS**

Magazine "TELAFFY", 4 sheets, Santec Sogo Kenkyusho (Jul. 1998).

Catalog, "iMac", 3 sheets, Apple Computer Co., Ltd., (Sep. 1998).

*Primary Examiner*—Richelle Shelton  
*Attorney, Agent, or Firm*—Rader, Fishman & Grauer

[57] **CLAIM**

The ornamental design for a television monitor, as shown and described.

**DESCRIPTION**

FIG. 1 is a perspective view of a first embodiment of a television monitor showing my new design;  
 FIG. 2 is a reduced top plan view of the embodiment of FIG. 1;  
 FIG. 3 is a left side elevational view thereof;  
 FIG. 4 is a front elevational view thereof;  
 FIG. 5 is a bottom plan view thereof.  
 FIG. 6 is a right side elevational view thereof; and  
 FIG. 7 is a rear elevational view thereof.  
 FIG. 8 is a perspective view of a second embodiment of a television monitor showing my new design;  
 FIG. 9 is a reduced top plan view of the embodiment of FIG. 8;  
 FIG. 10 is a left side elevational view thereof;  
 FIG. 11 is a front elevational view thereof;  
 FIG. 12 is a bottom plan view thereof.  
 FIG. 13 is a right side elevational view thereof; and,  
 FIG. 14 is a rear elevational view thereof.

**1 Claim, 6 Drawing Sheets**

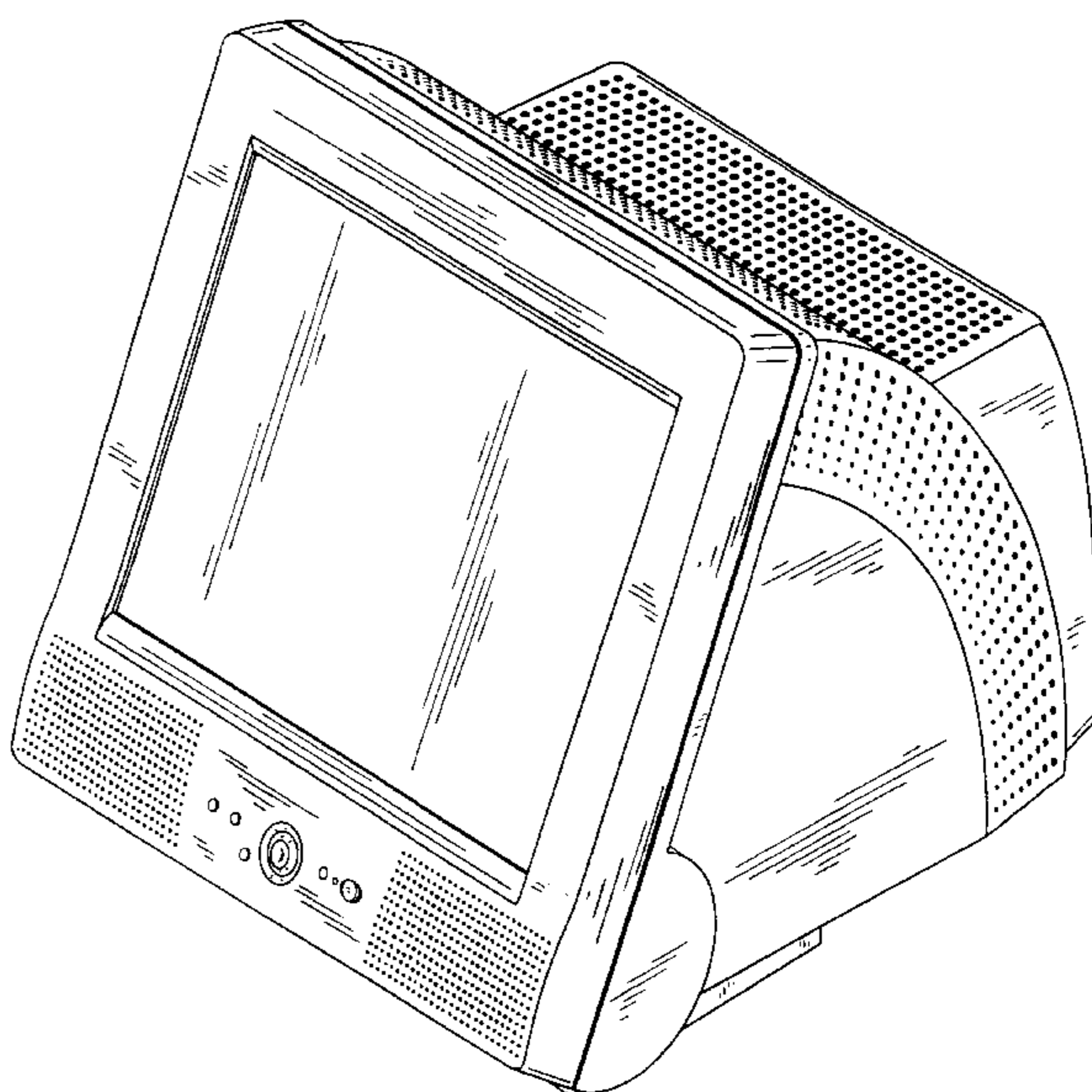
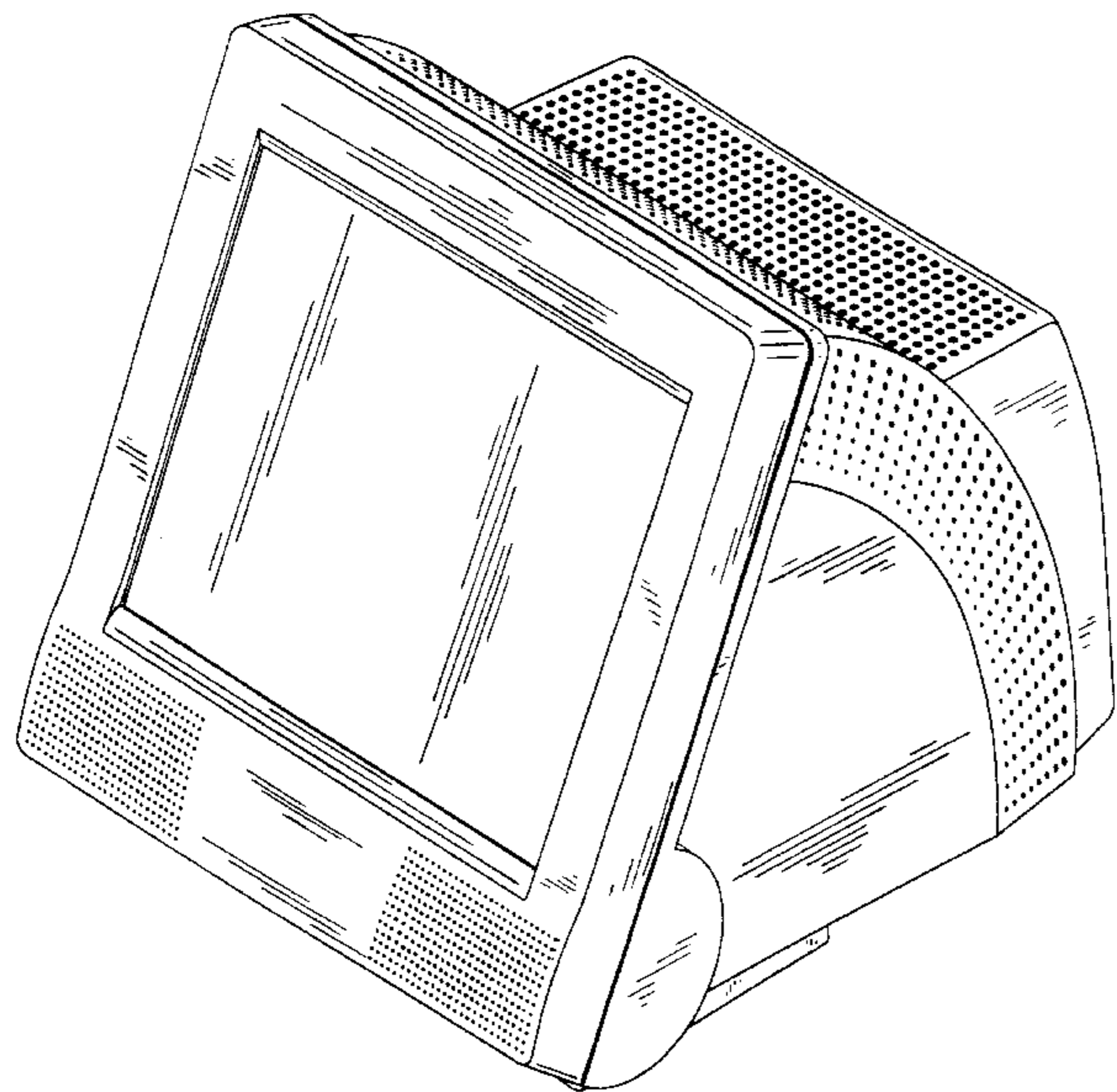

FIG. 1

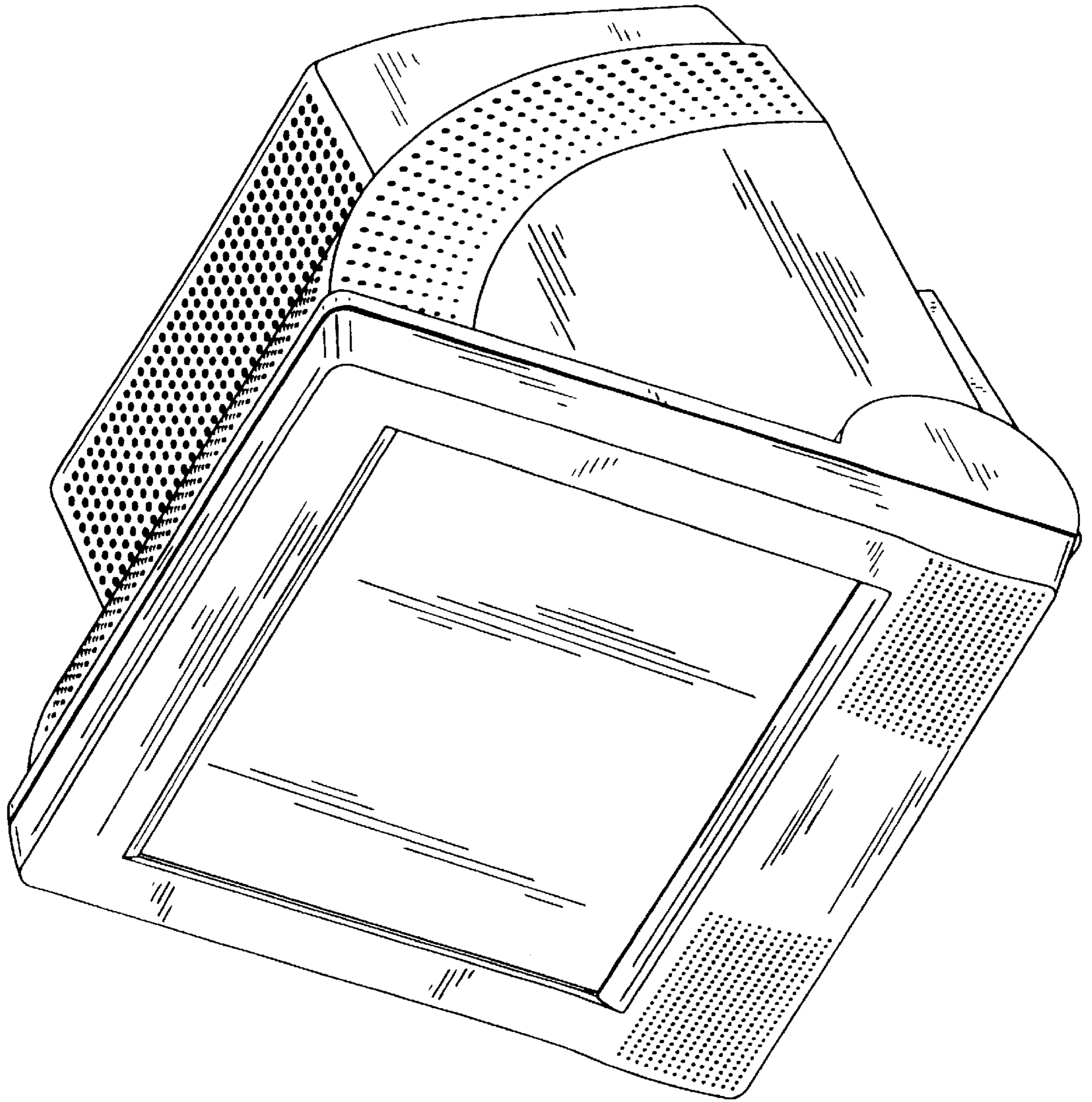

FIG. 2

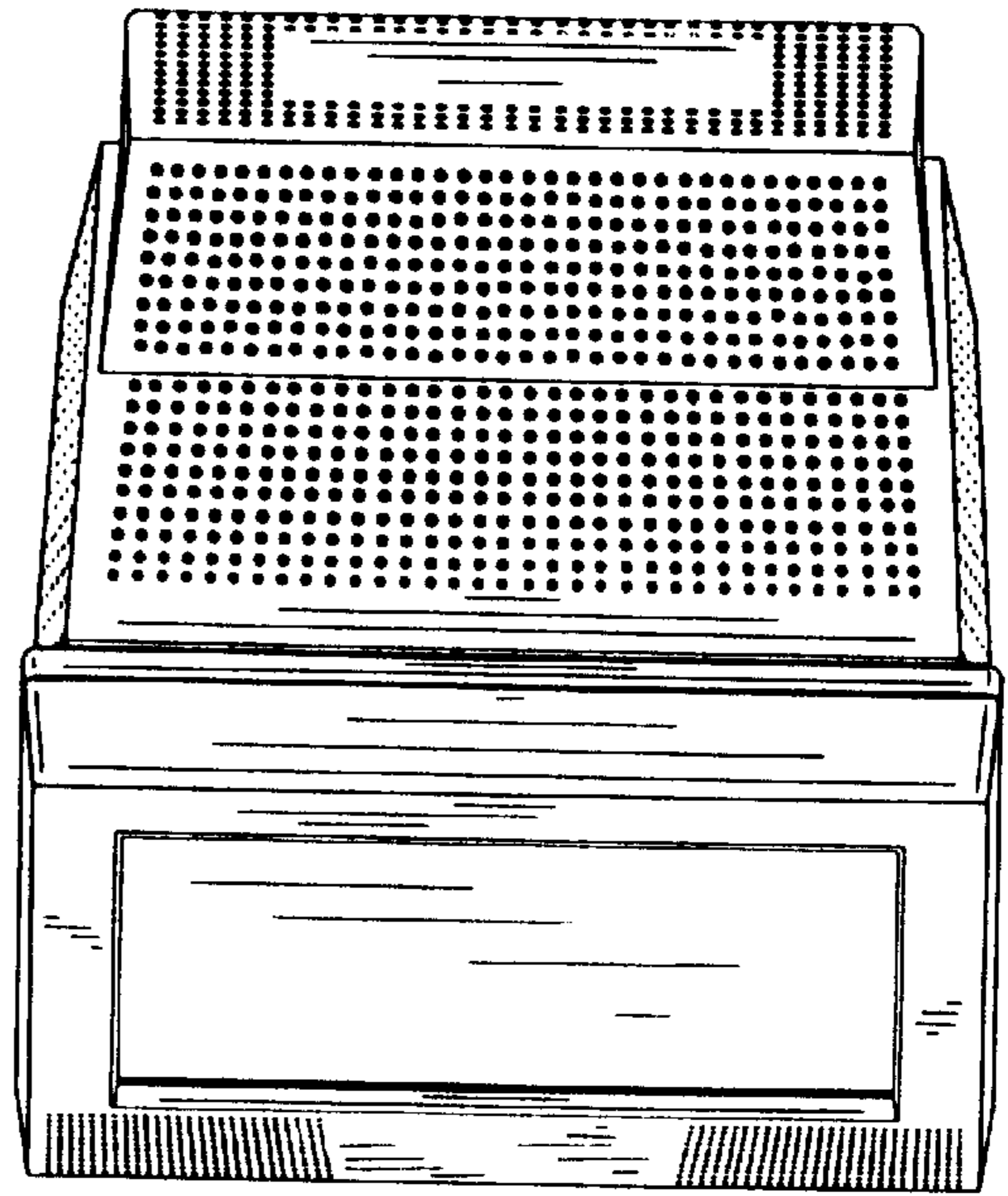

FIG. 3

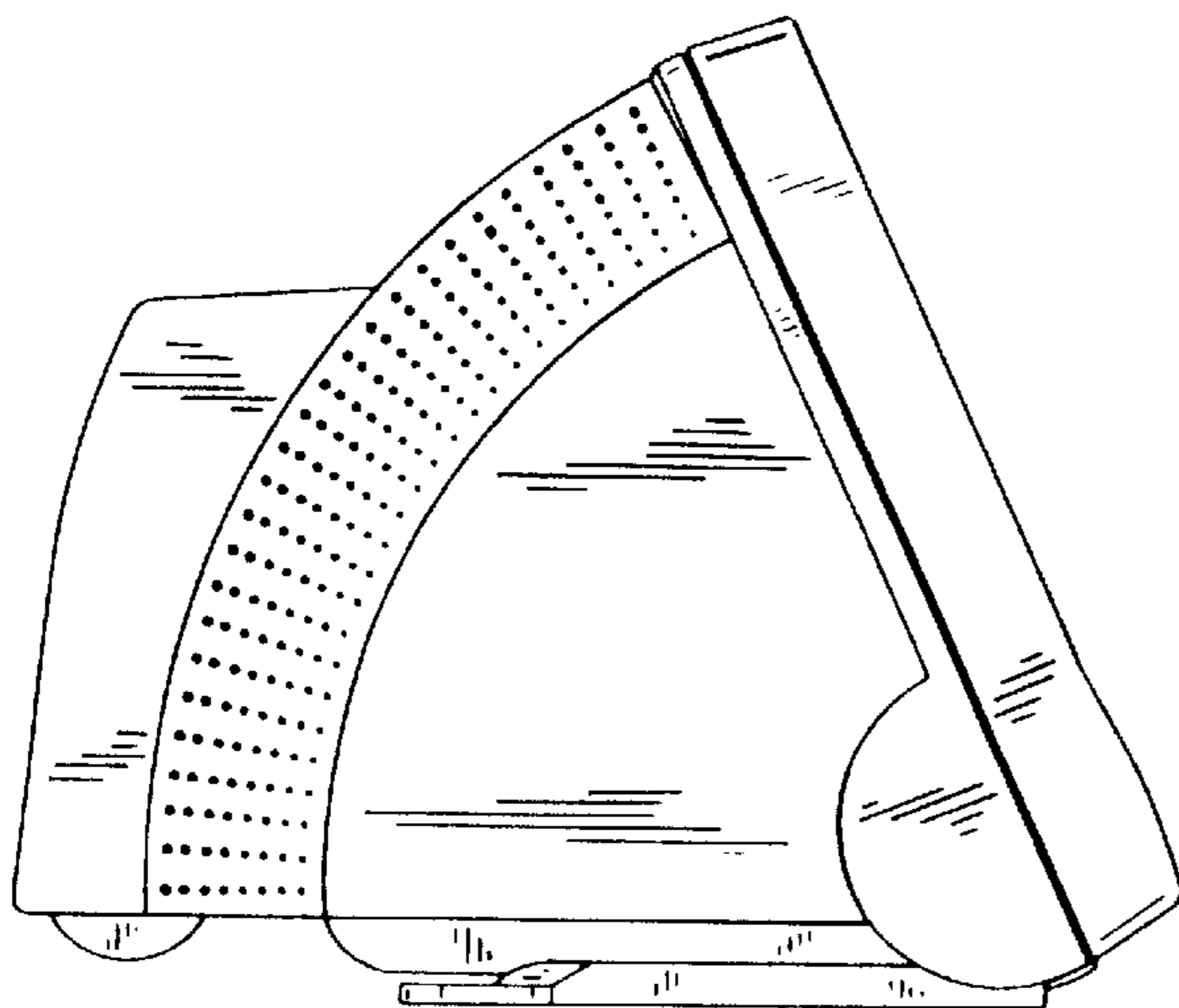

FIG. 4

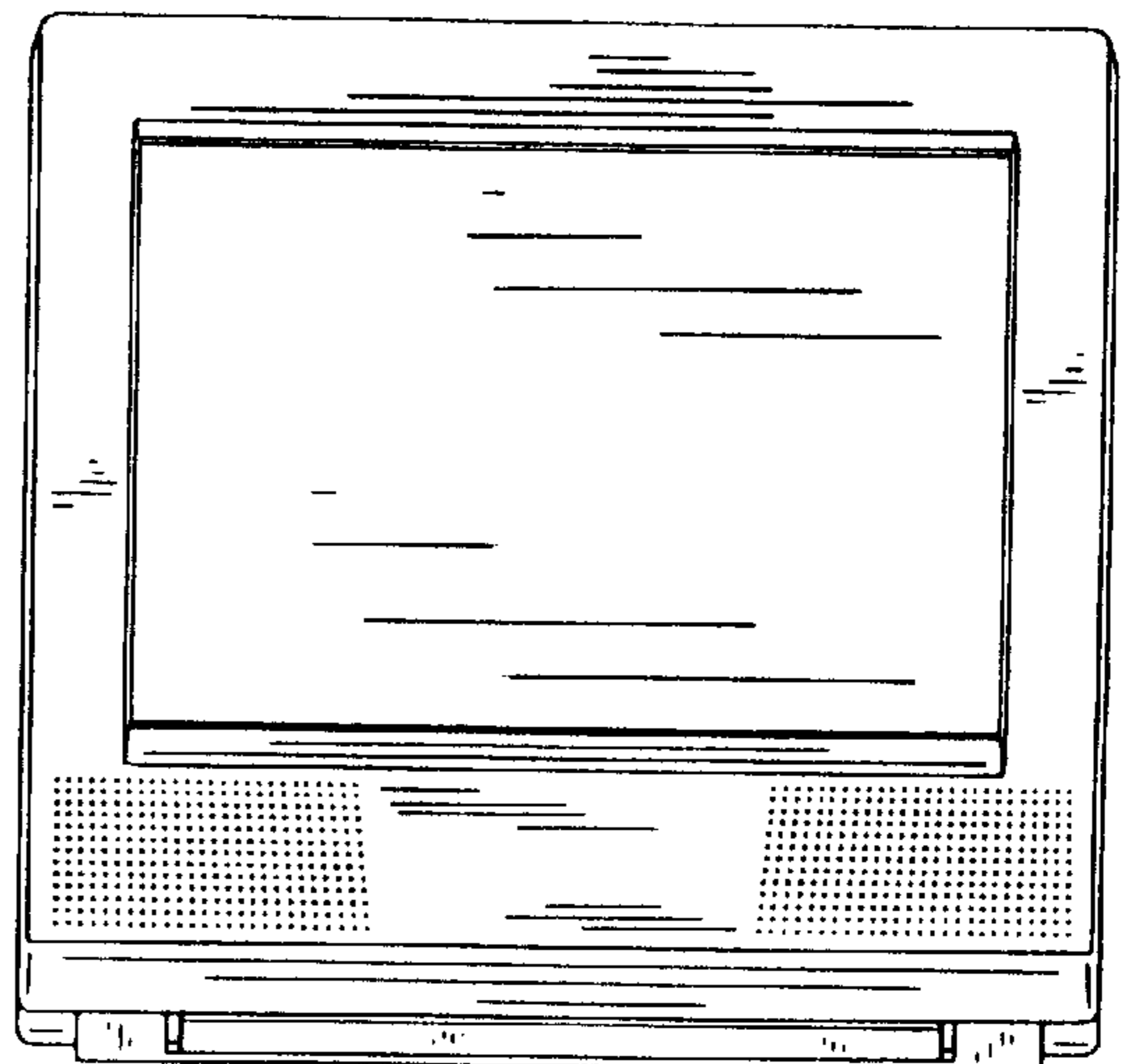



FIG. 6

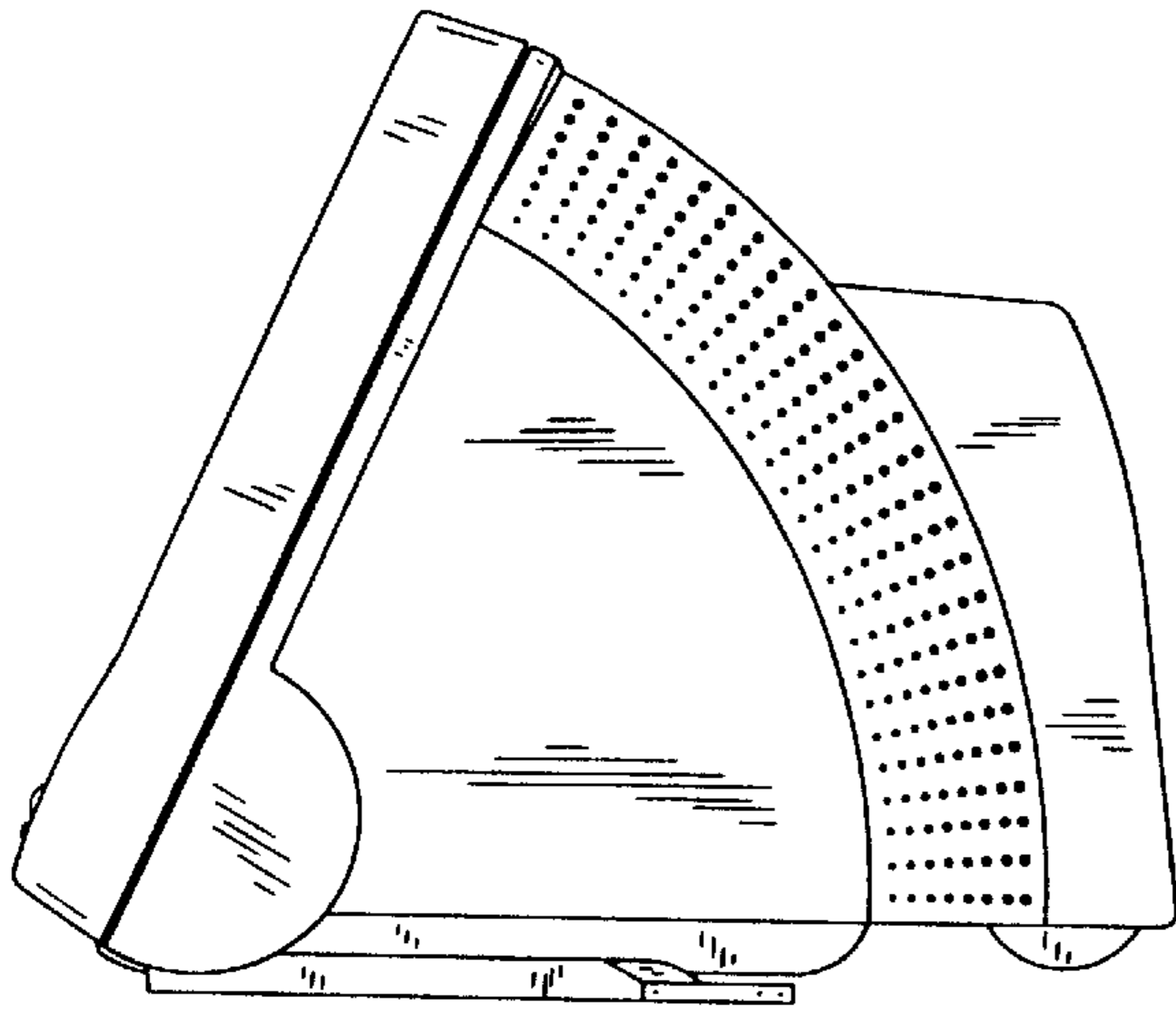

FIG. 7

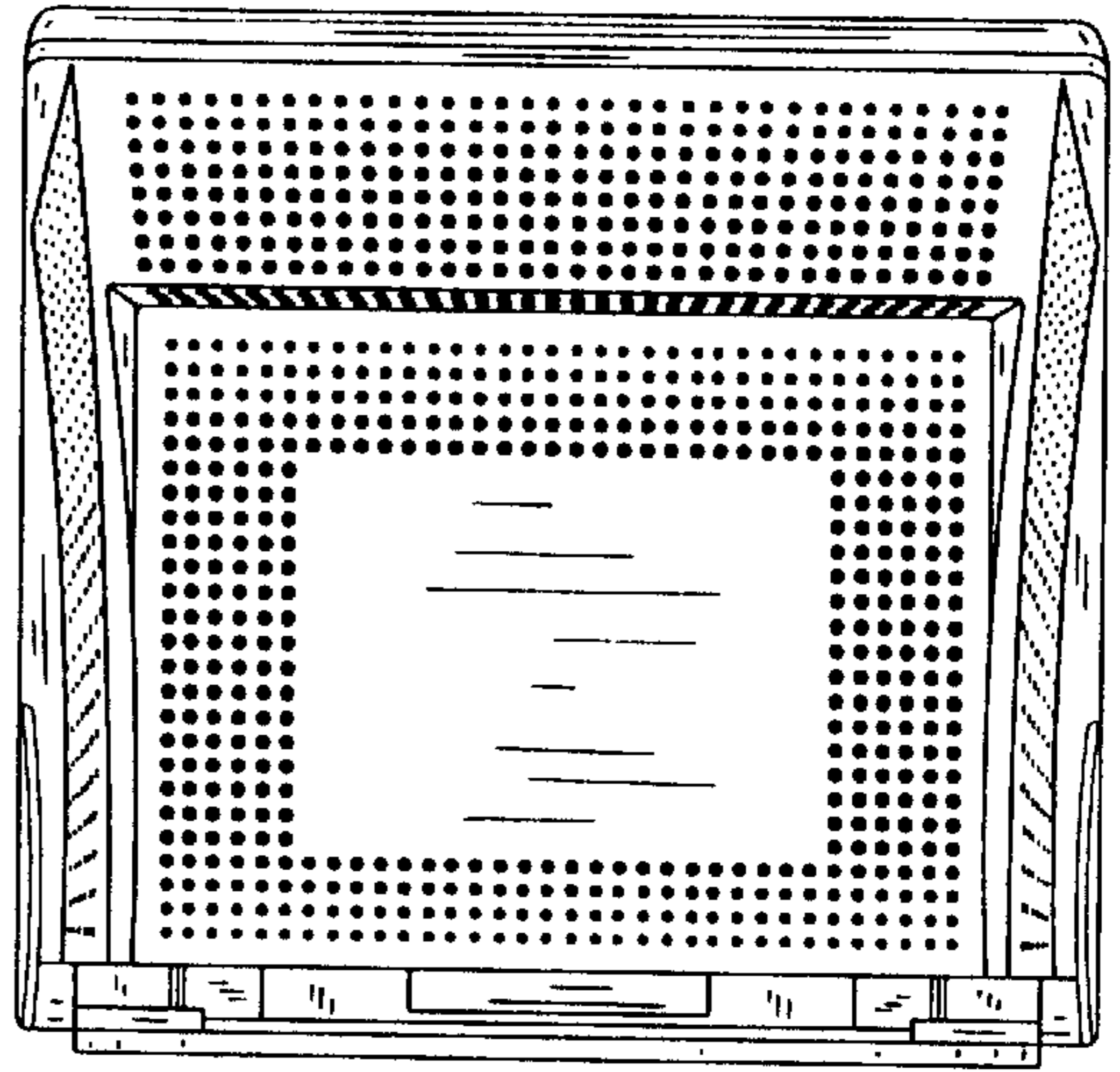

FIG. 5

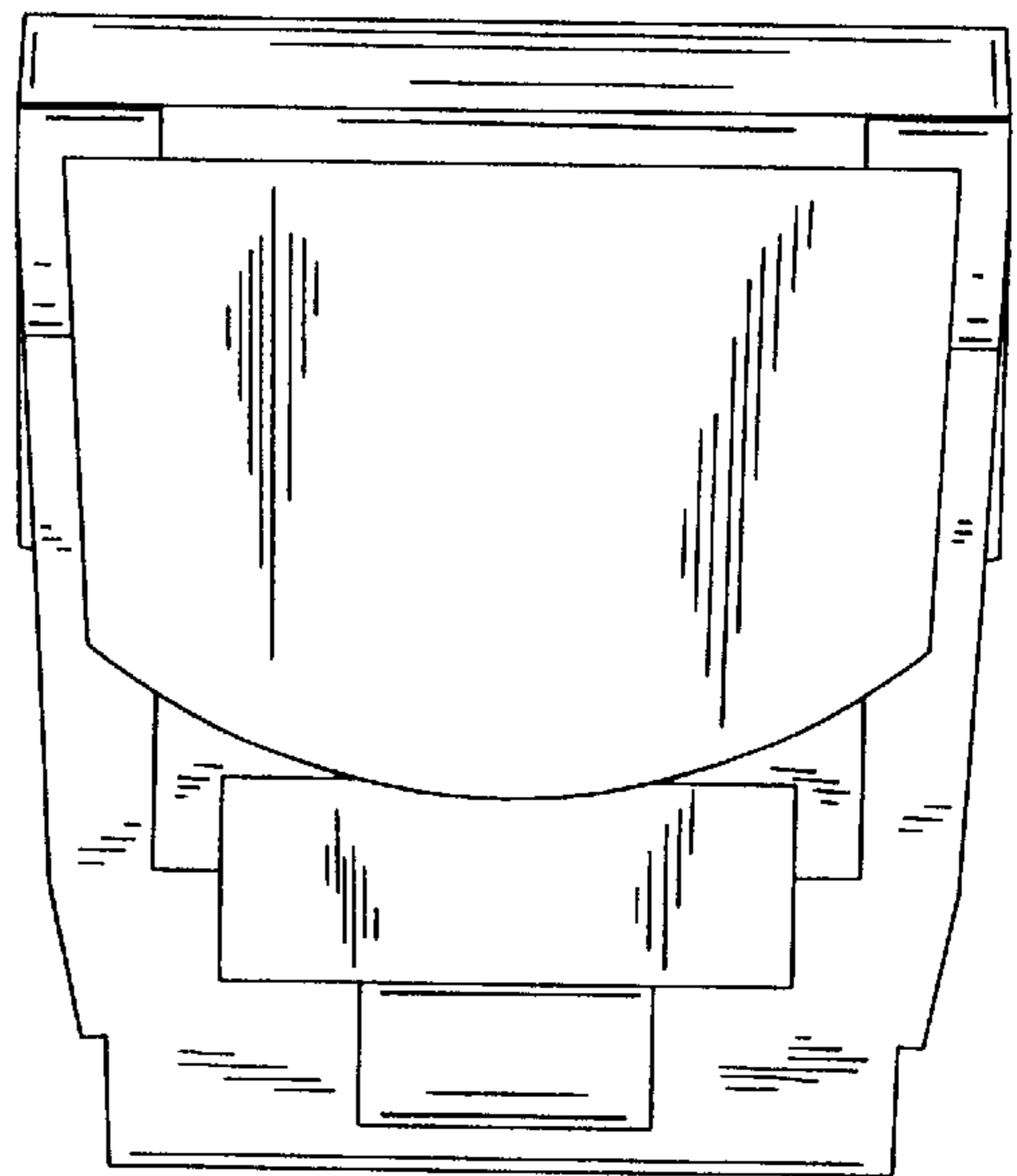

FIG. 8

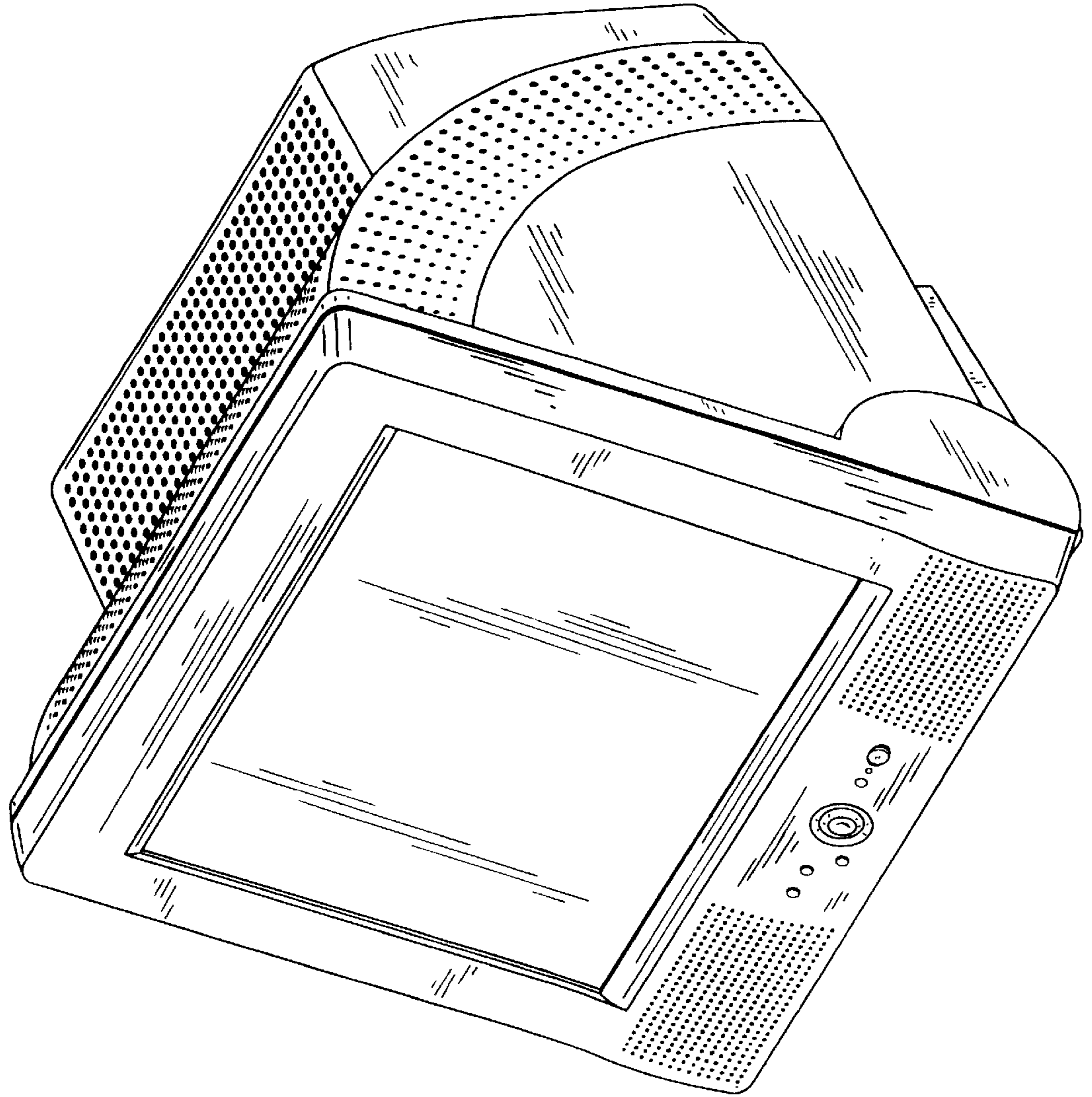

FIG. 9

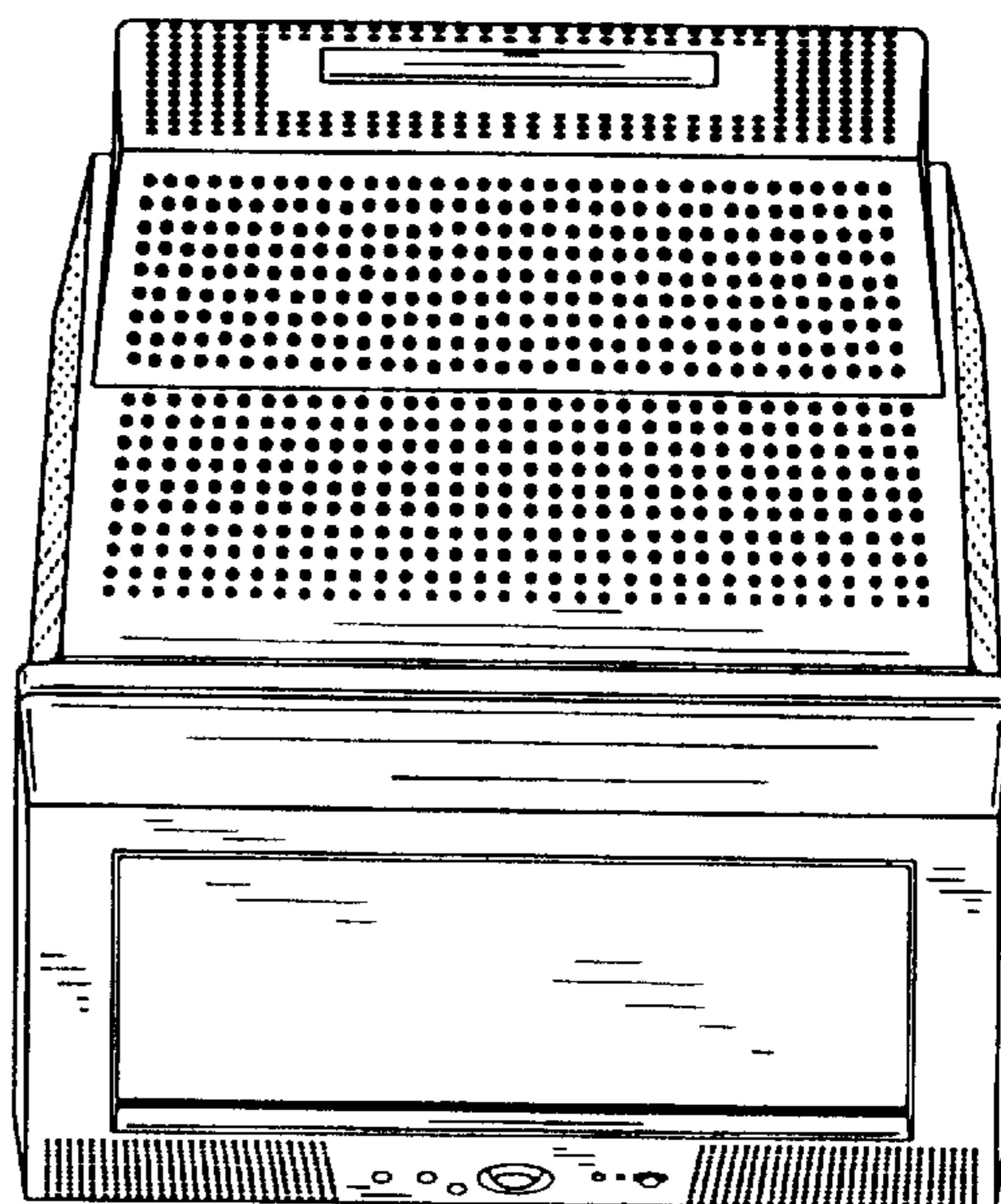

FIG. 10

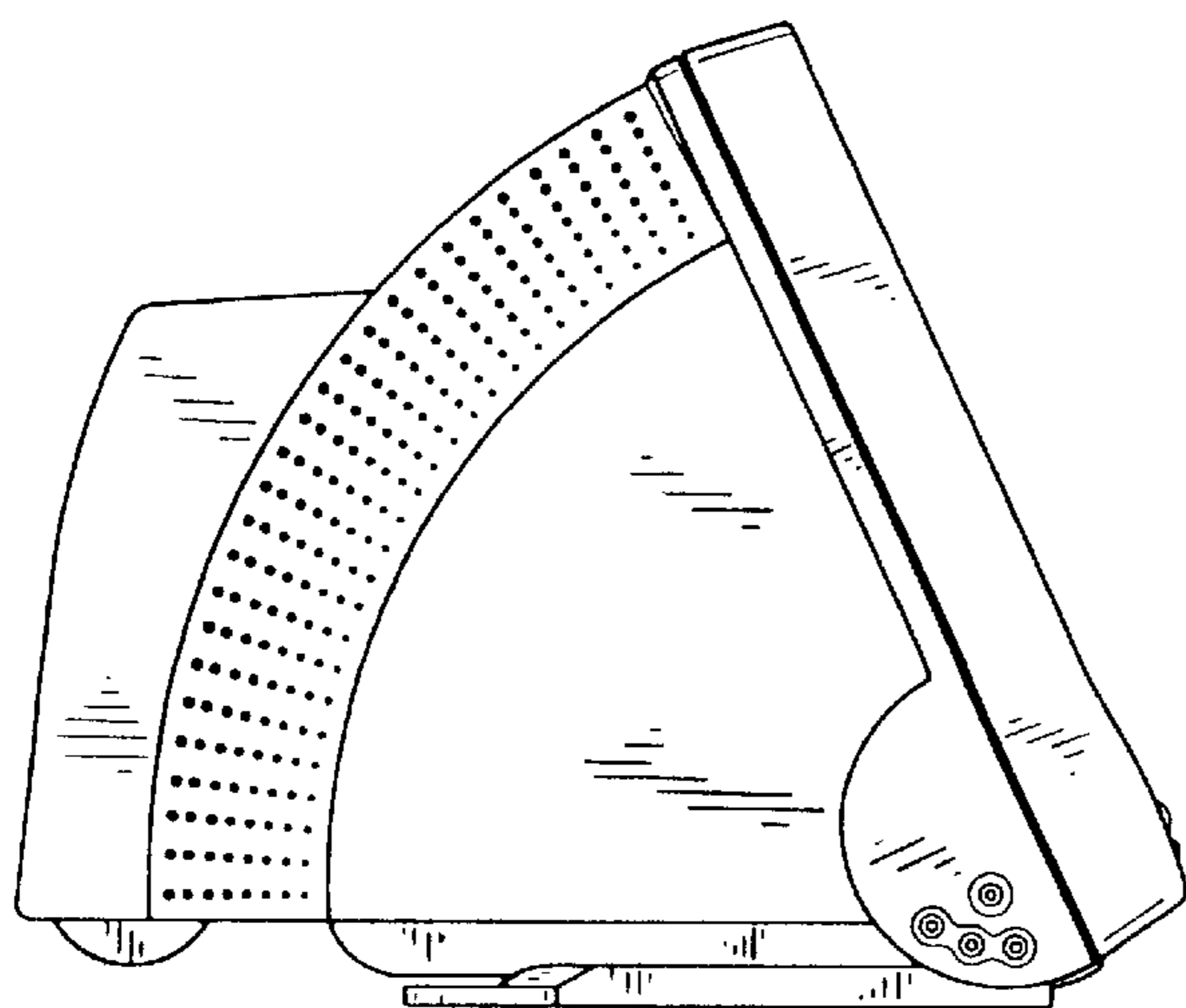

FIG. 11

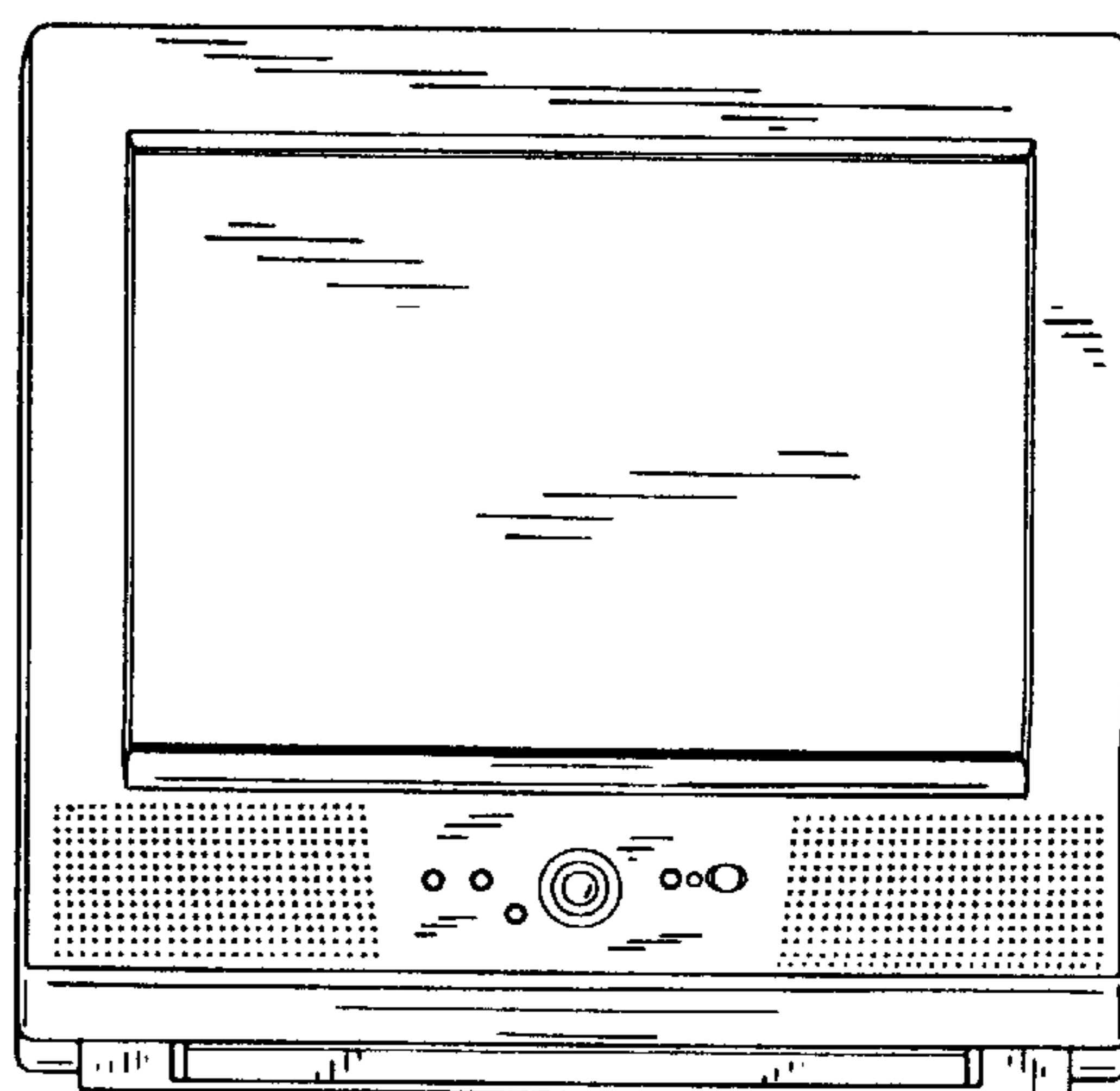

FIG. 13

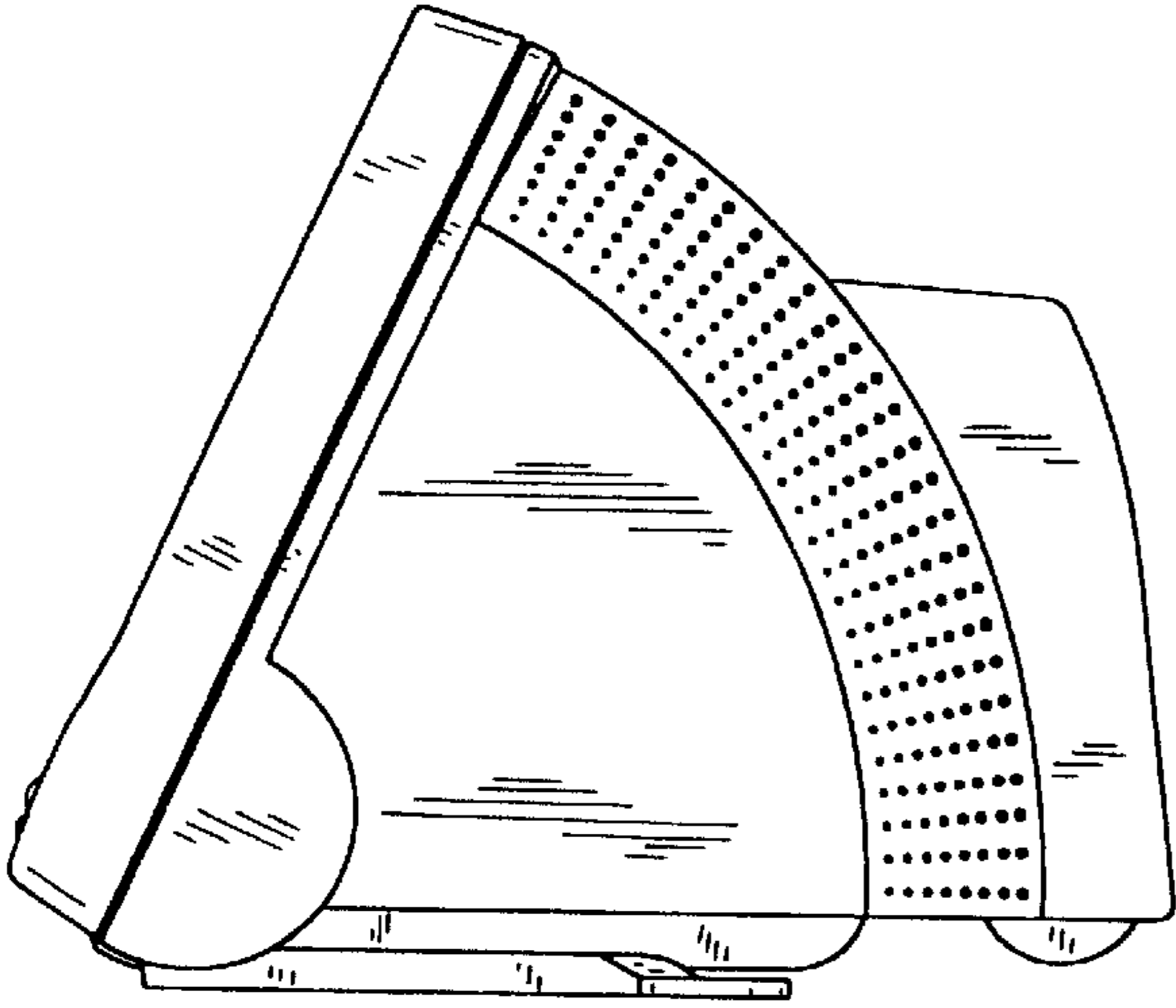

FIG. 14

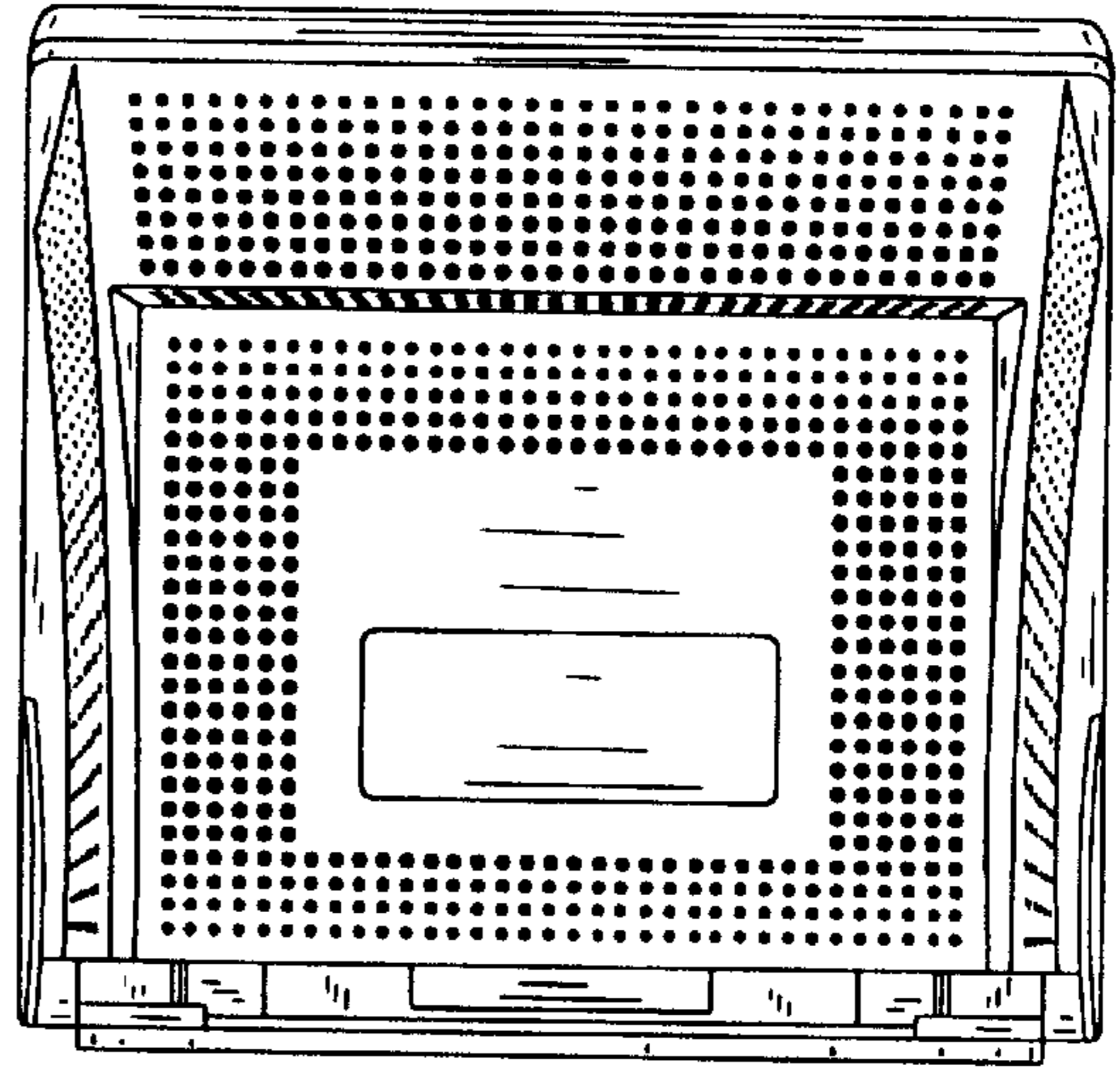

FIG. 12

