



US00D433301S

# United States Patent [19] Pack

[11] **Patent Number: Des. 433,301**

[45] **Date of Patent: \*\* Nov. 7, 2000**

[54] **HOT GLUE GUN STAND**

[76] Inventor: **Carl E Pack**, 3220 Pinewood Rd.,  
Sumter, S.C. 29154

[\*\*] Term: **14 Years**

[21] Appl. No.: **29/101,205**

[22] Filed: **Feb. 26, 1999**

[51] **LOC (7) Cl.** ..... **08-05**

[52] **U.S. Cl.** ..... **D8/71**

[58] **Field of Search** ..... D8/71, 14.1, 70,  
D8/29.1, 30; D13/108; 219/158, 159, 227,  
228, 229, 242, 246, 247, 259; 248/117.2,  
176

[56] **References Cited**

**U.S. PATENT DOCUMENTS**

D. 290,221	6/1987	Wilson et al.	.....	D8/71
D. 303,611	9/1989	Spirk, Jr. et al.	.....	D8/71
D. 307,105	4/1990	Nusse et al.	.....	D8/71
D. 308,932	7/1990	Straub	.....	D8/71
D. 315,283	3/1991	De Carolis et al.	.....	D8/71

D. 413,502	9/1999	Chang	.....	D8/71
4,692,587	9/1987	Spirk, Jr. et al.	.....	219/242
4,826,049	5/1989	Speer	.....	219/242
4,998,968	3/1991	Martinson	.....	248/176

*Primary Examiner*—Philip S. Hyder

[57] **CLAIM**

The ornamental design for a hot glue gun stand, as shown.

**DESCRIPTION**

FIG. 1 is a front elevational view of the hot glue gun stand of the present invention;  
 FIG. 2 is a back elevational view of the hot glue gun stand of FIG. 1;  
 FIG. 3 is a left side elevational view of the hot glue gun stand of FIG. 1;  
 FIG. 4 is a right side elevational view of the hot glue gun stand of FIG. 1;  
 FIG. 5 is a top plan view of the hot glue gun stand of FIG. 1; and,  
 FIG. 6 is a bottom plan view of the hot glue gun stand of FIG. 1.

**1 Claim, 2 Drawing Sheets**

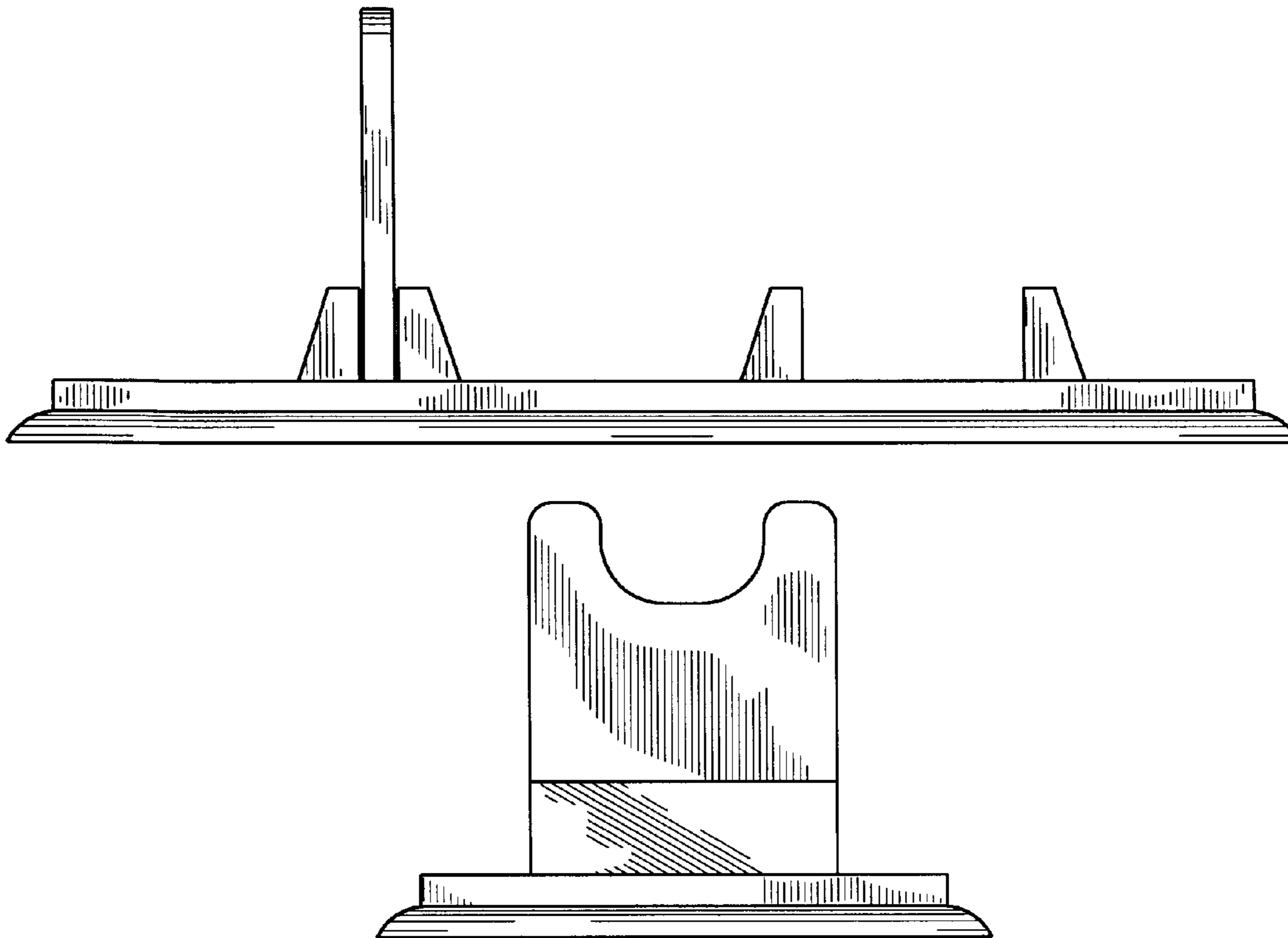

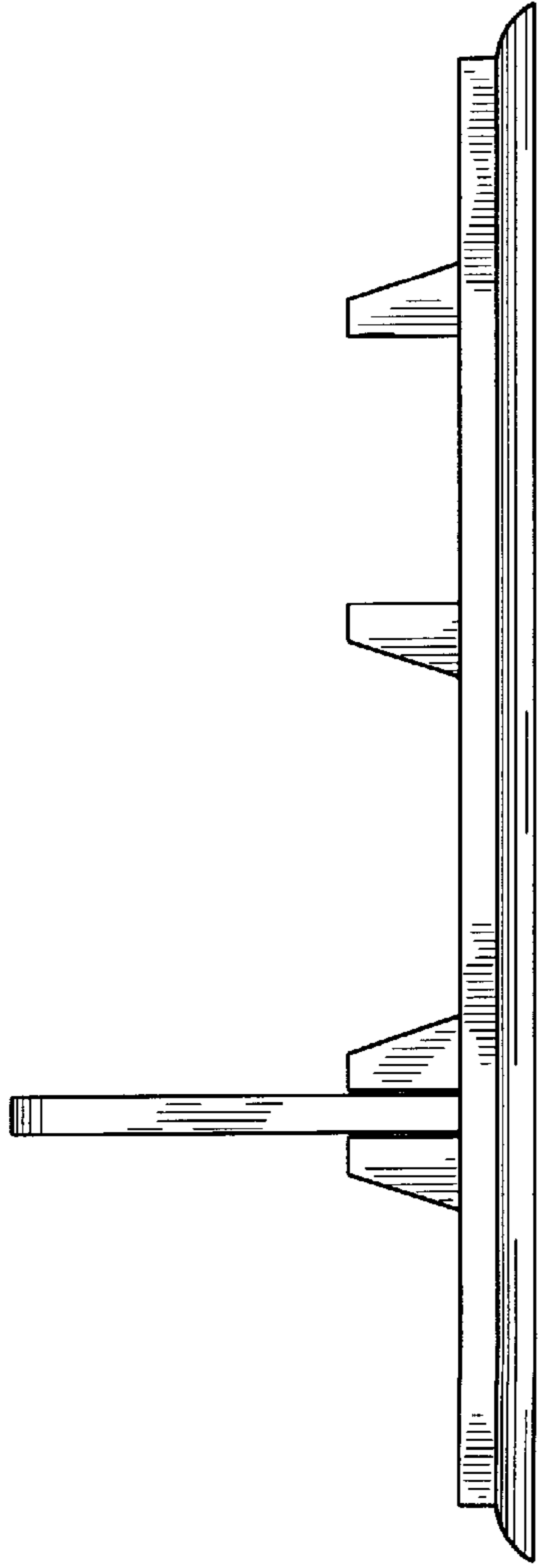

Figure 1

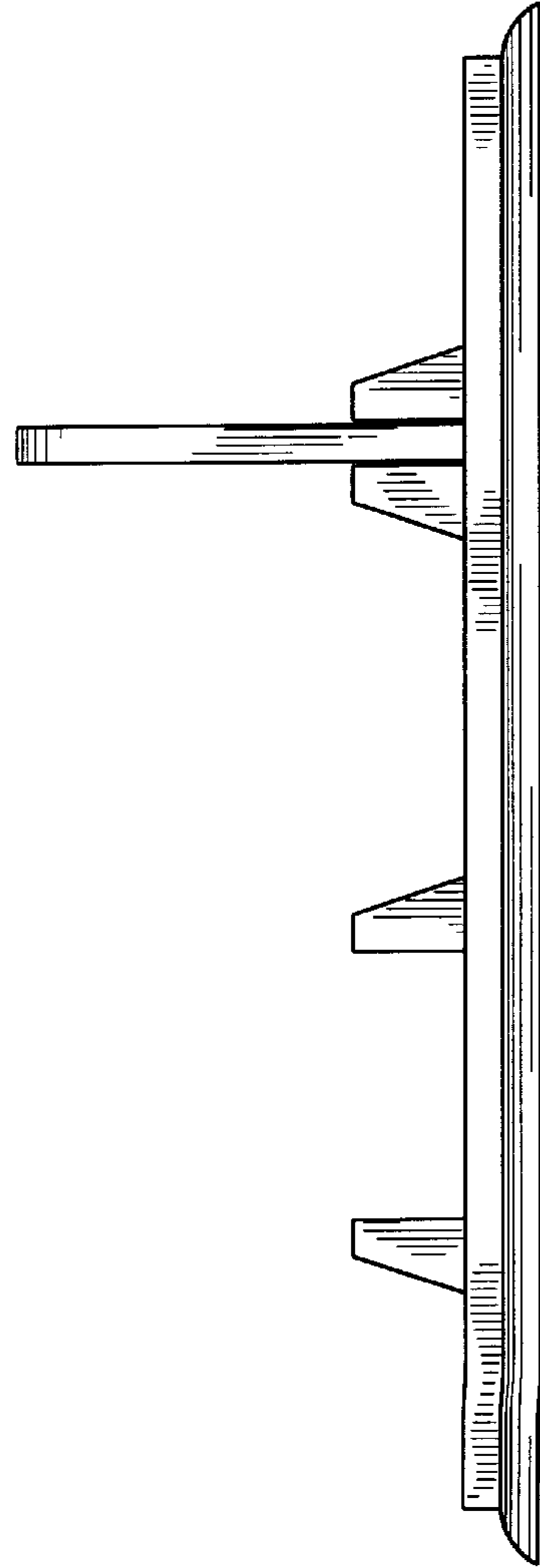

Figure 2

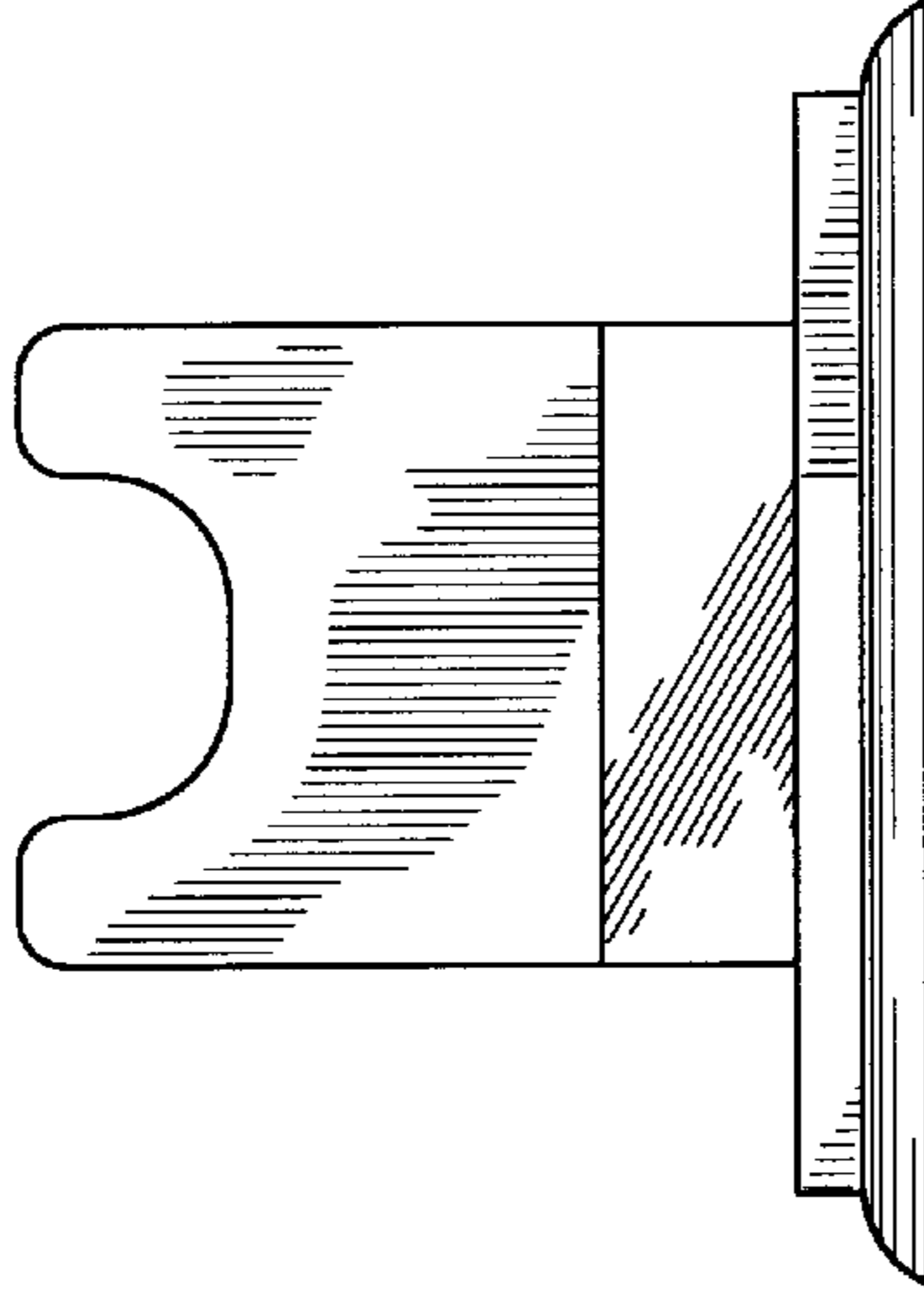

Figure 3

Figure 6

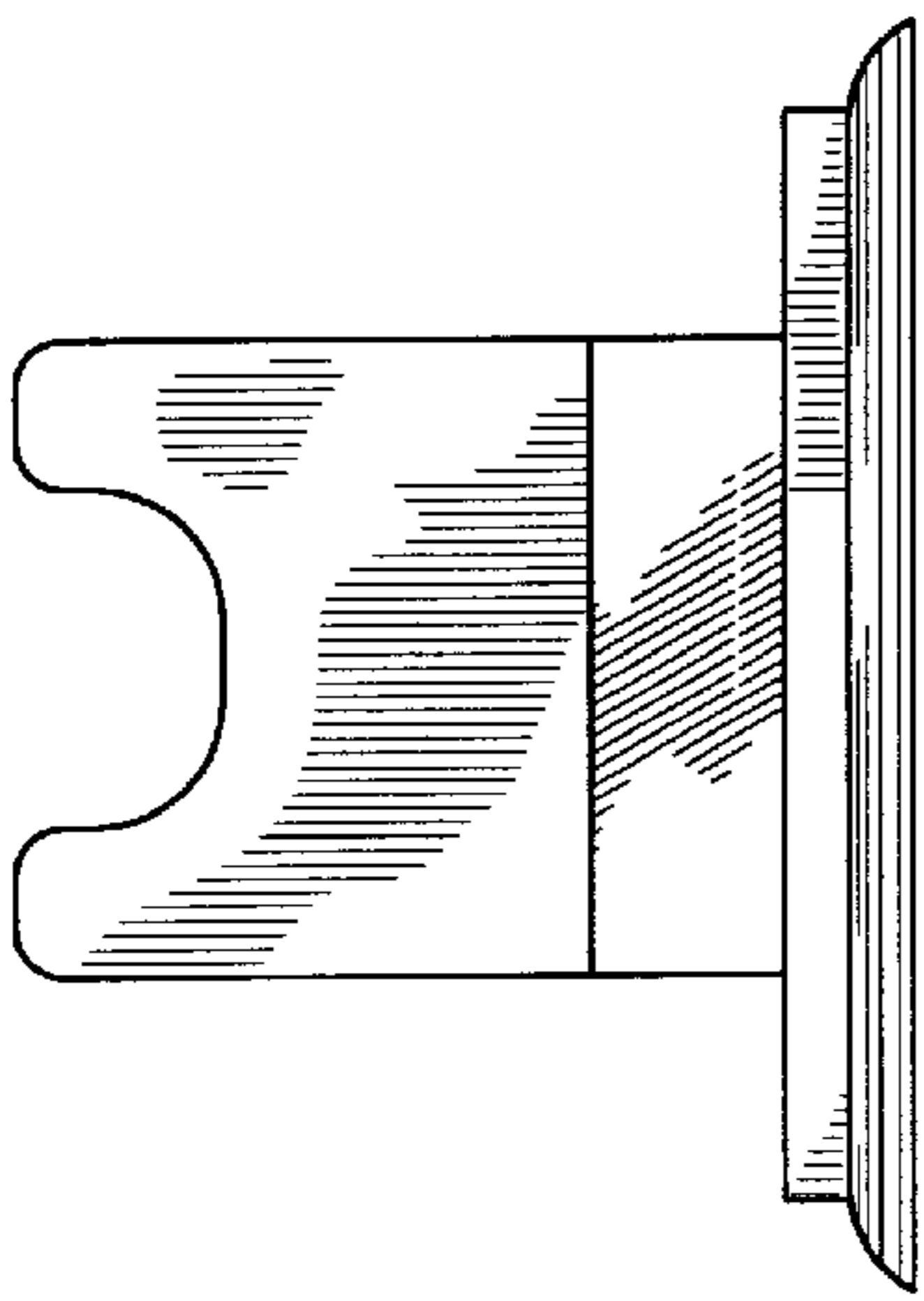
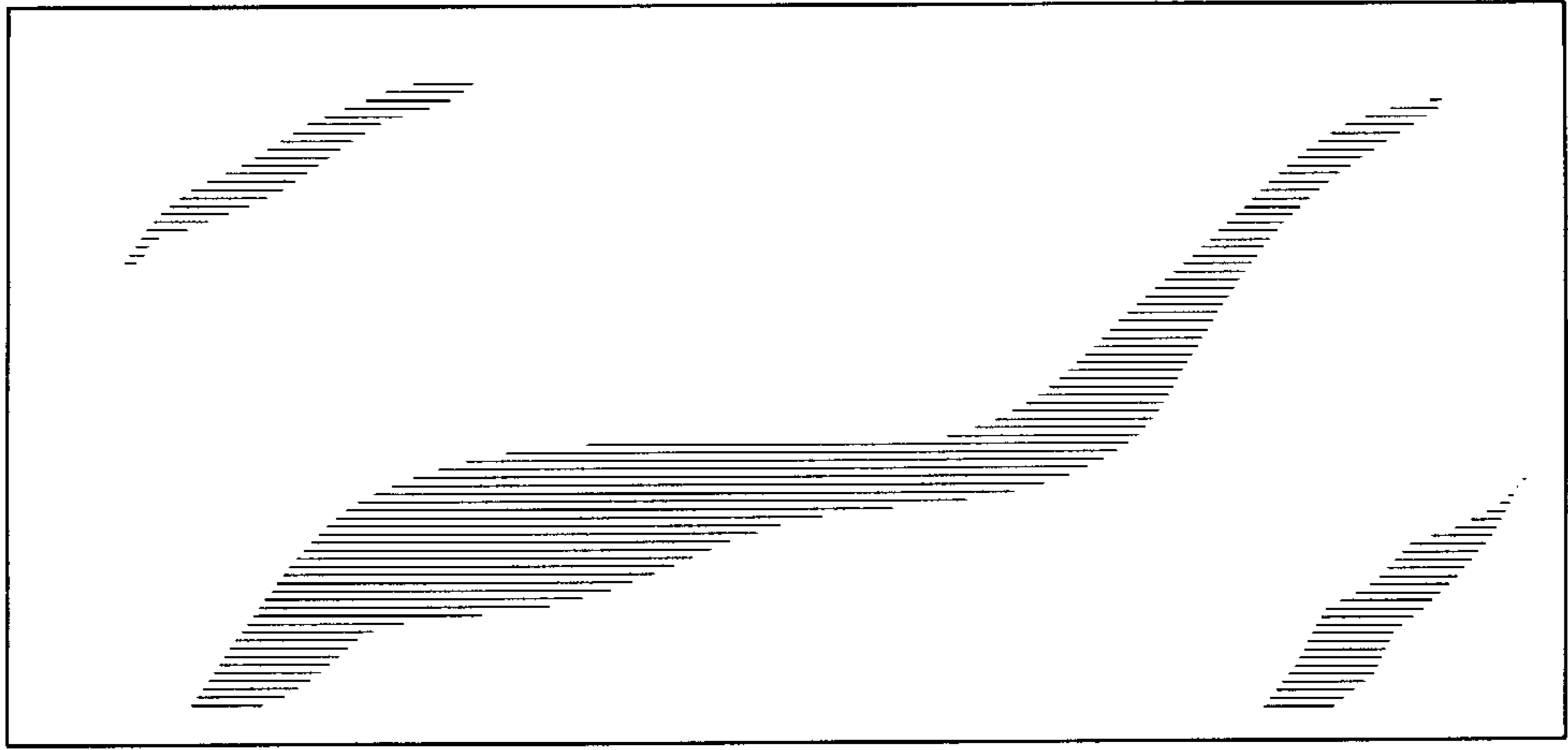

Figure 4

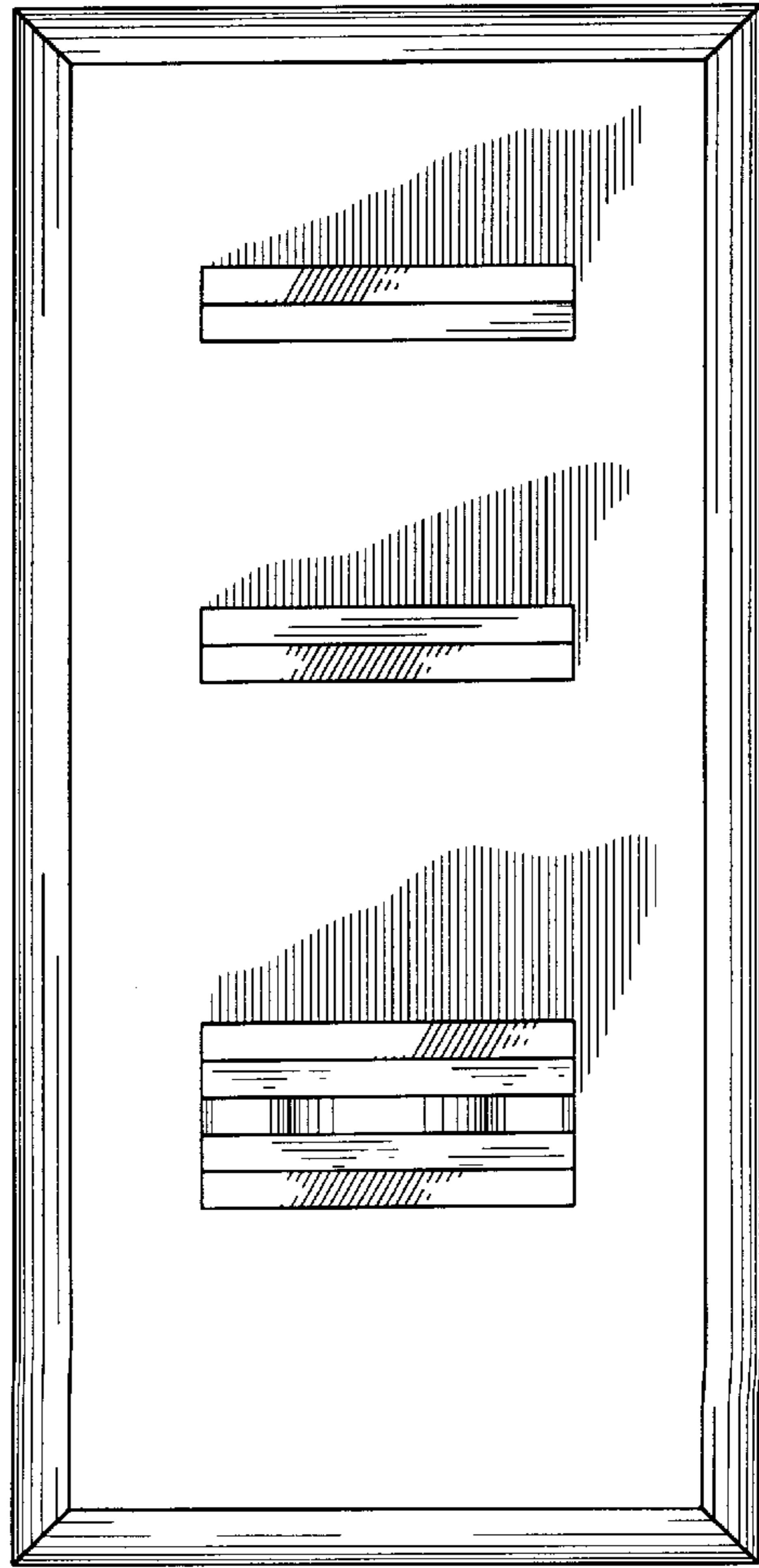

Figure 5