



US00D433248S

United States Patent [19]
Hellwig et al.

[11] **Patent Number: Des. 433,248**

[45] **Date of Patent: ** Nov. 7, 2000**

[54] **CABINET**

[75] Inventors: **John Hellwig**, Toronto; **Steven Verbeek**, Aurora, both of Canada; **Thomas M. Edwards**, Spring Lake; **Errol Stafford Pearsons**, Grand Haven, both of Mich.

[73] Assignee: **Teknion Furniture Systems Limited**, Downsview, Canada

[**] Term: **14 Years**

[21] Appl. No.: **29/109,227**

[22] Filed: **Aug. 13, 1999**

[51] **LOC (7) Cl.** **06-04**

[52] **U.S. Cl.** **D6/441; D6/445**

[58] **Field of Search** D6/432-448, 414, D6/509, 510; D34/12, 19, 21; 312/198, 200

[56] **References Cited**

U.S. PATENT DOCUMENTS

D. 264,781	6/1982	Azzalla	D6/445
D. 327,186	6/1992	Tarlow	D6/441
D. 336,706	6/1993	Lechman et al.	D34/19 X
D. 410,351	6/1999	Magnusson	D6/446
D. 412,628	8/1999	Lewis	D6/441

Primary Examiner—Cathron B. Matta
Attorney, Agent, or Firm—Bereskin & Parr

[57] **CLAIM**

The ornamental design for a cabinet, as shown.

DESCRIPTION

FIG. 1 is a perspective view from above and to one side of the cabinet in accordance with a first embodiment of our design;
 FIG. 2 is a front elevational view;
 FIGS. 3 and 4 are left and right side elevational views respectively;
 FIG. 5 is a top plan view;
 FIG. 6 is a rear elevational view;
 FIG. 7 is a perspective view from above and to one side of the cabinet in accordance with a second embodiment of our design;
 FIG. 8 is a front elevational view;
 FIGS. 9 and 10 are left and right side elevational views respectively;
 FIG. 11 is a top plan view;
 FIG. 12 is a rear elevational view;
 FIG. 13 is a perspective view from above and to one side of the cabinet in accordance with a second embodiment of our design;
 FIG. 14 is a front elevational view;
 FIGS. 15 and 16 are left and right side elevational views respectively;
 FIG. 17 is a top plan view; and,
 FIG. 18 is a rear elevational view.

1 Claim, 7 Drawing Sheets

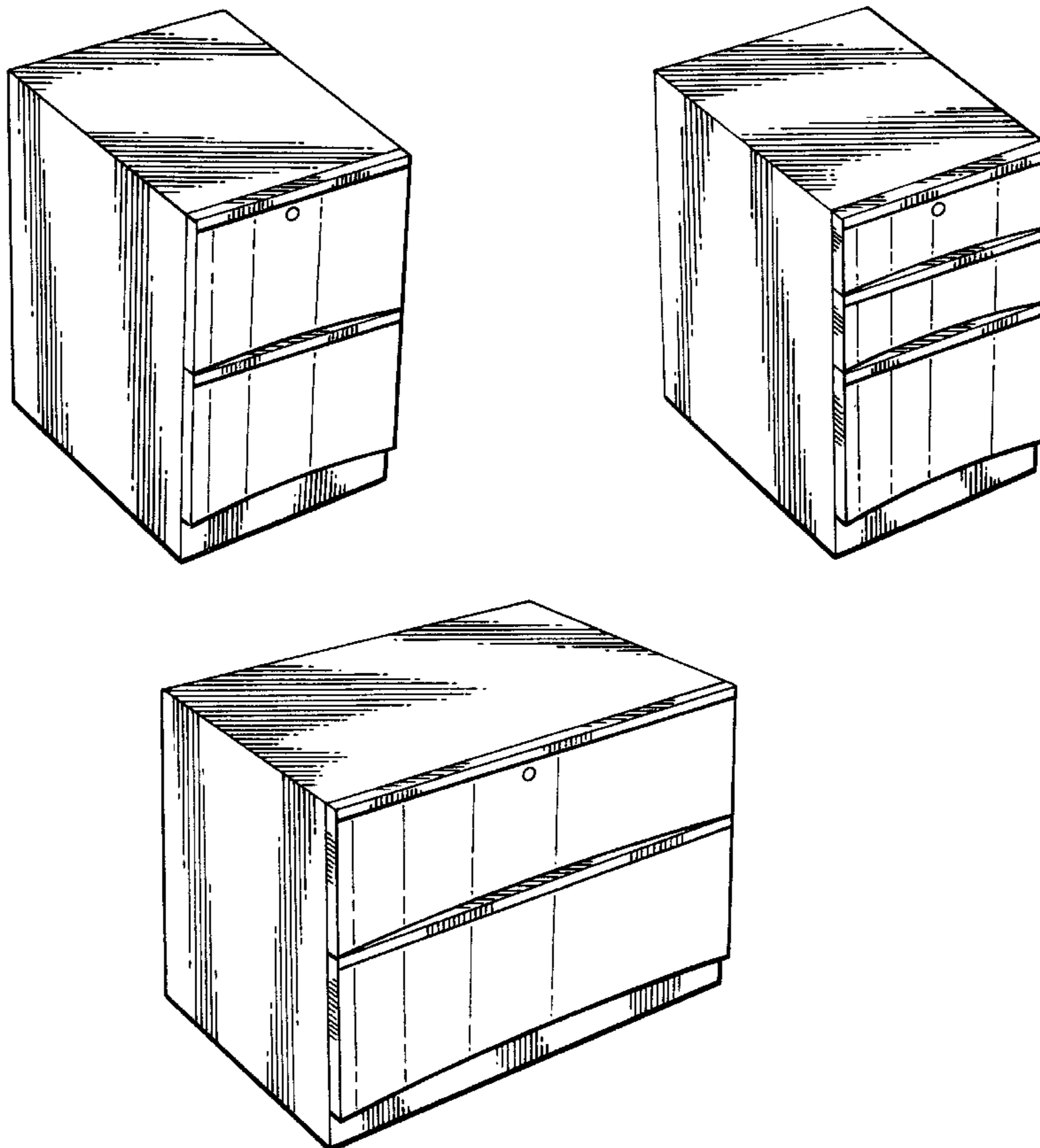

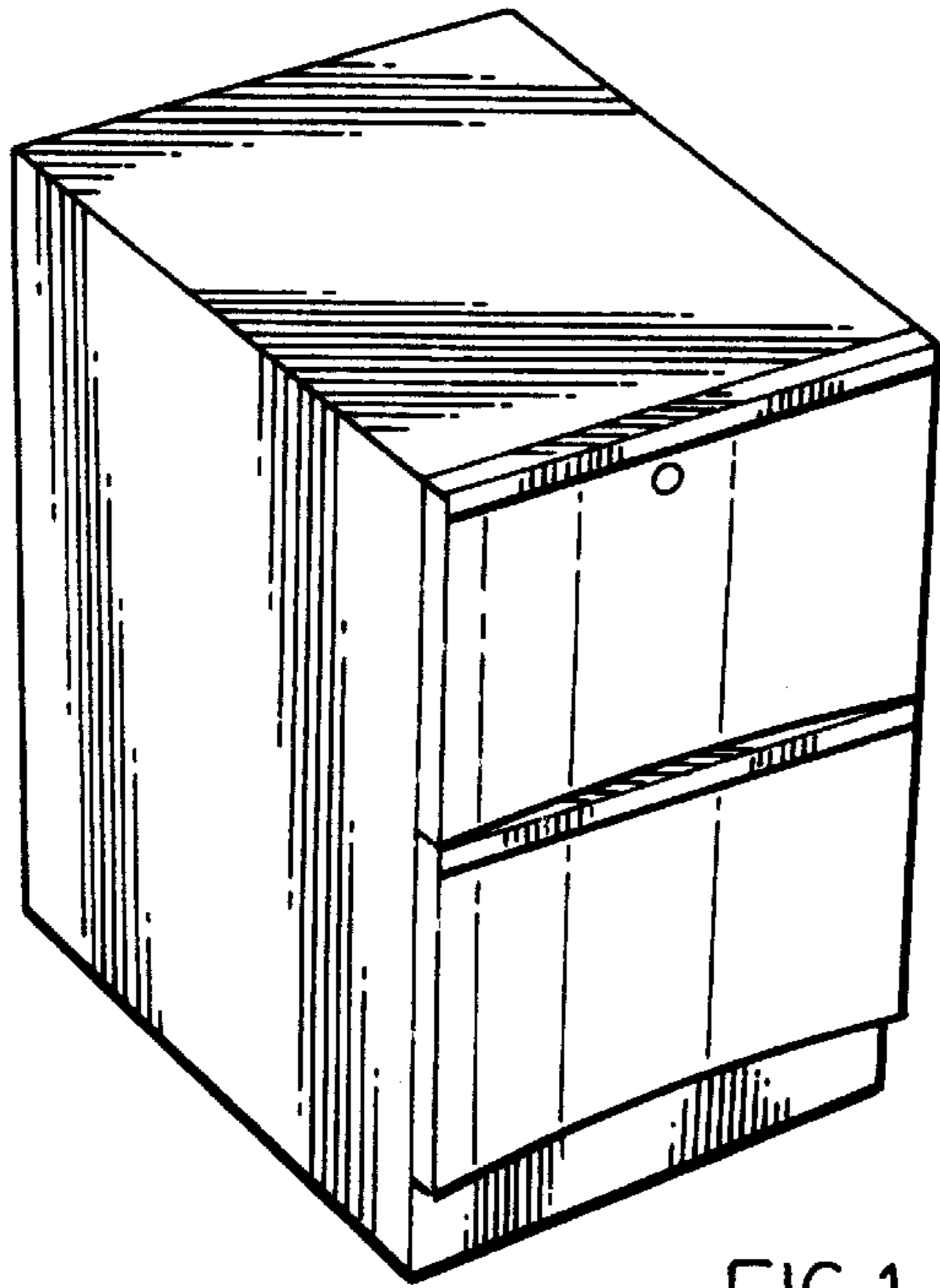

FIG. 1.

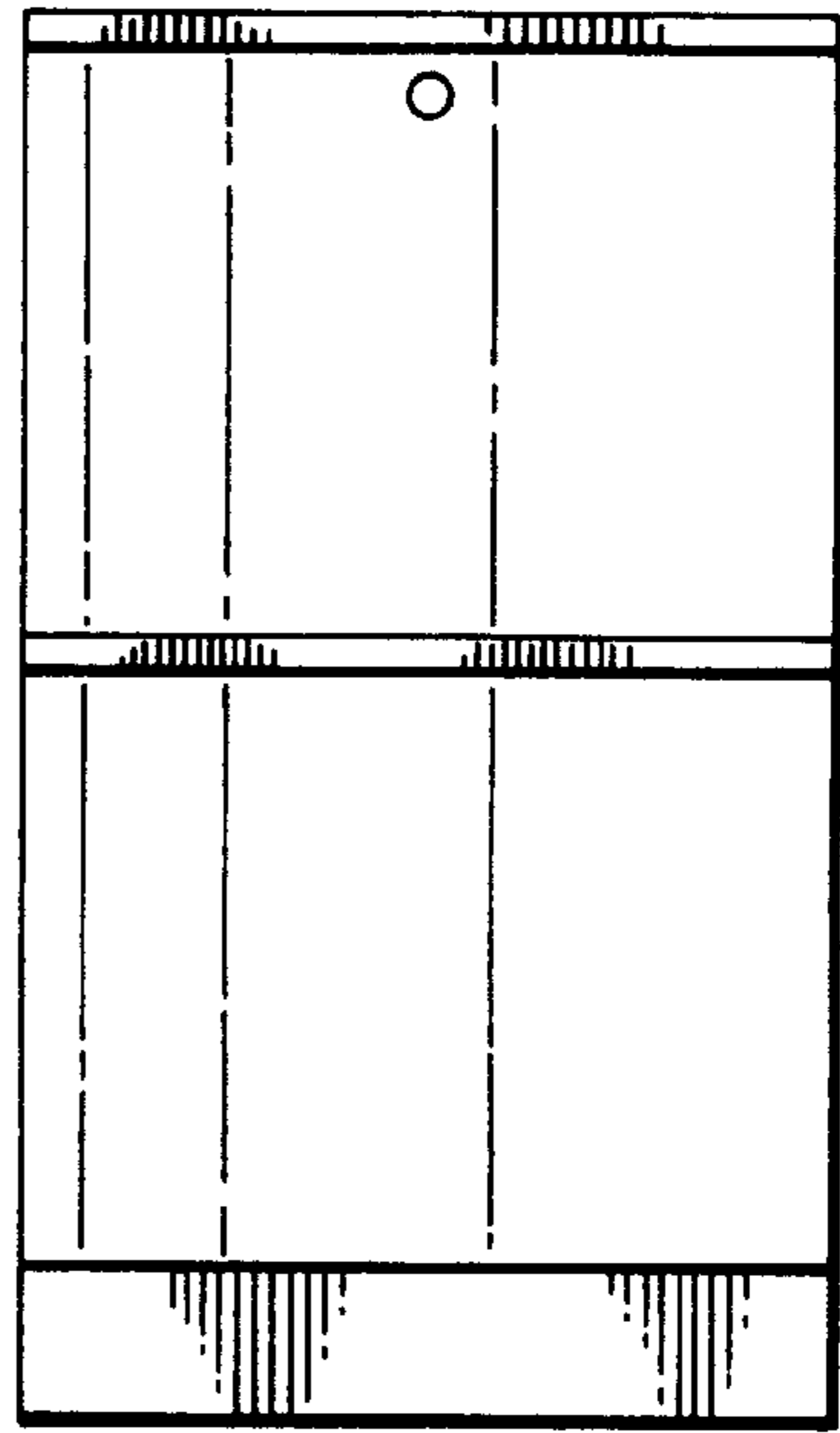

FIG. 2.

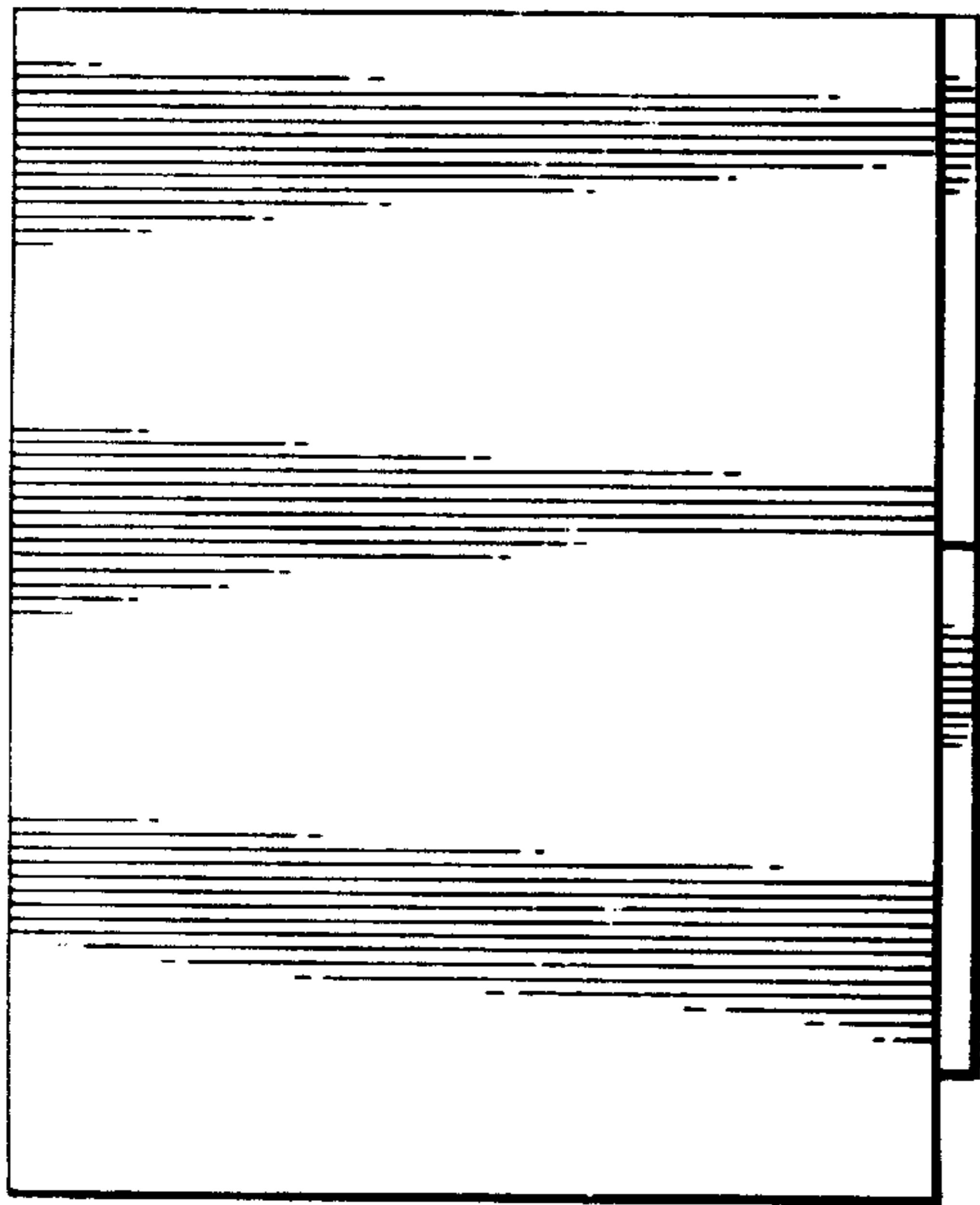

FIG. 3.

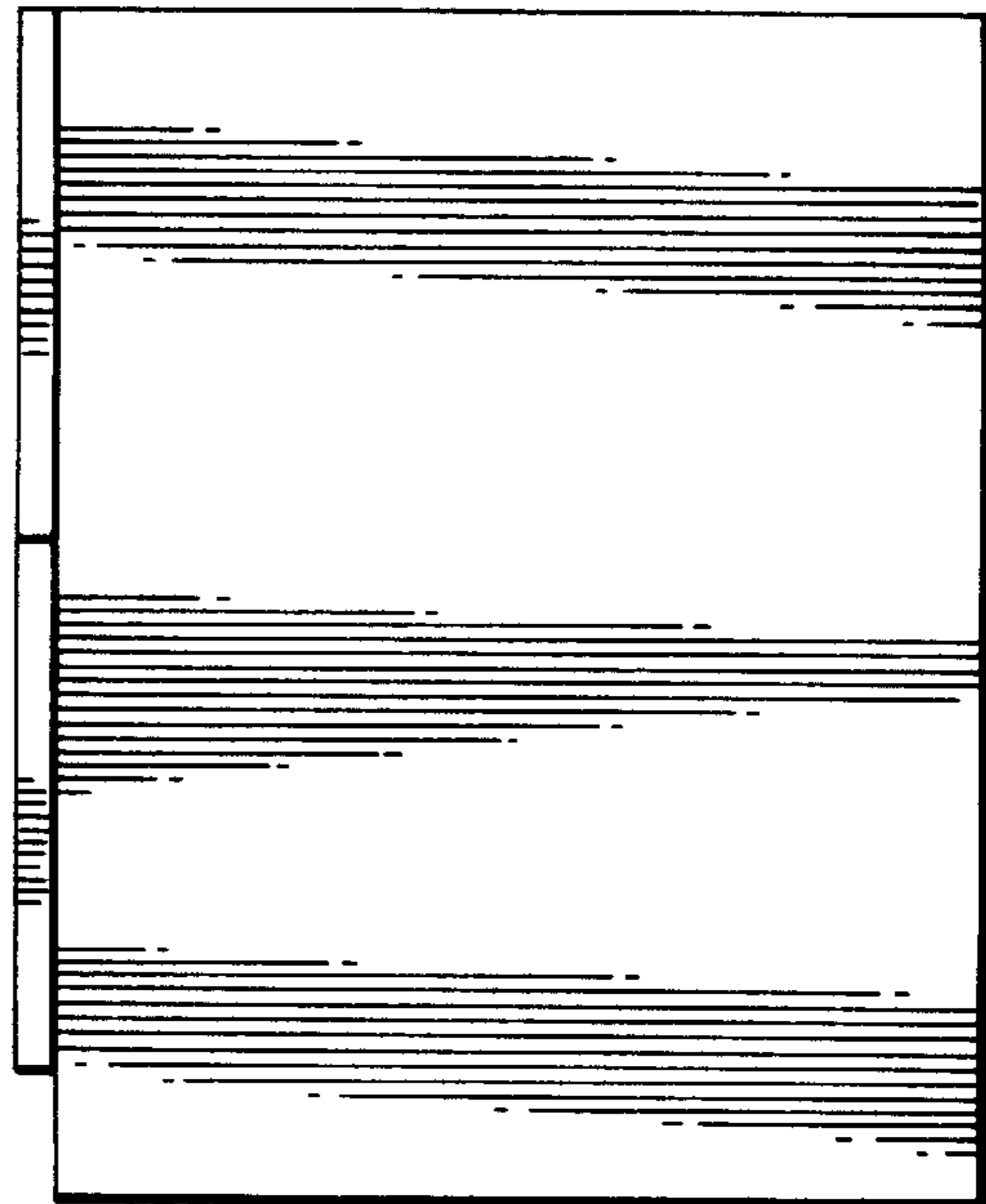

FIG. 4.

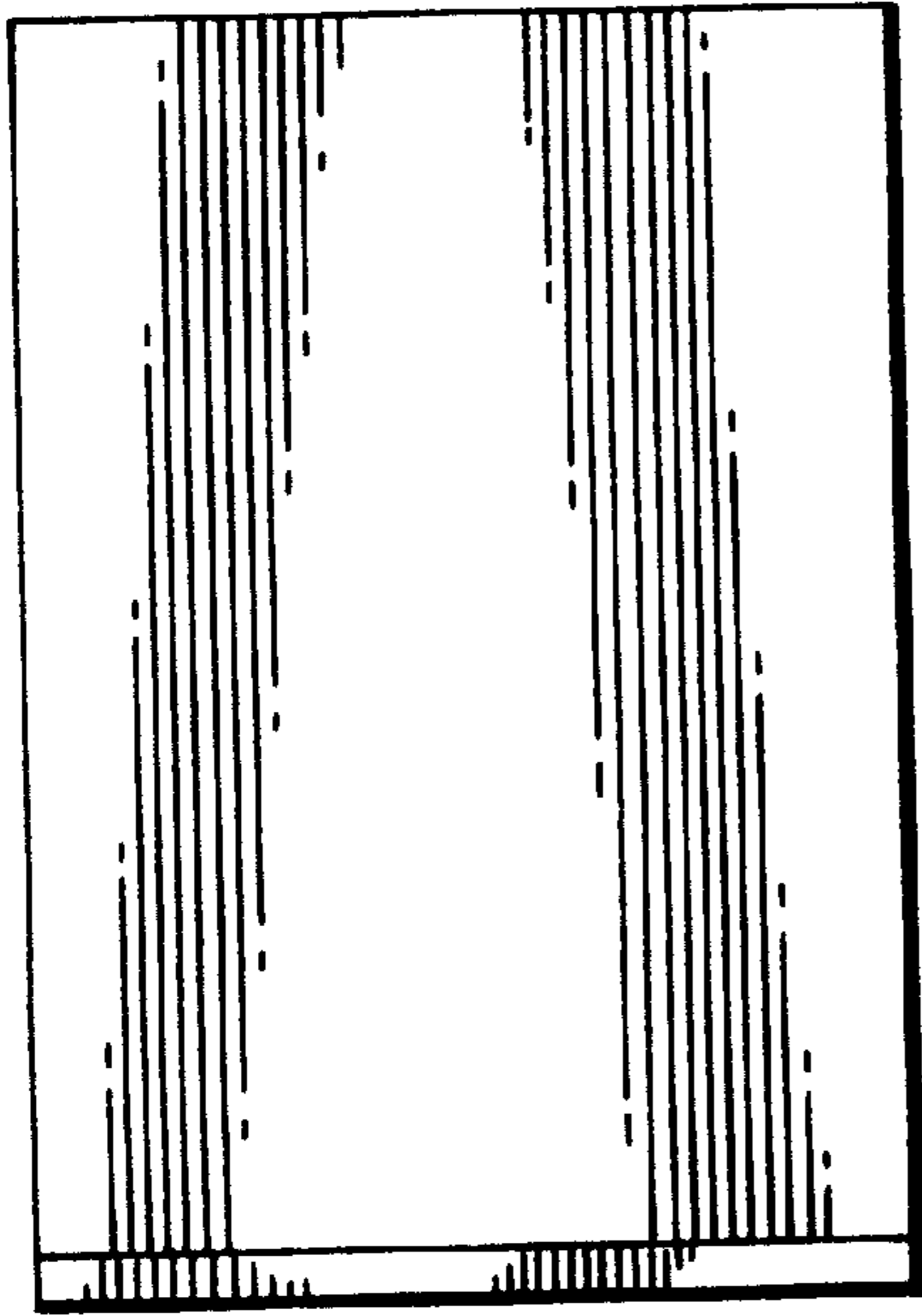

FIG. 5.

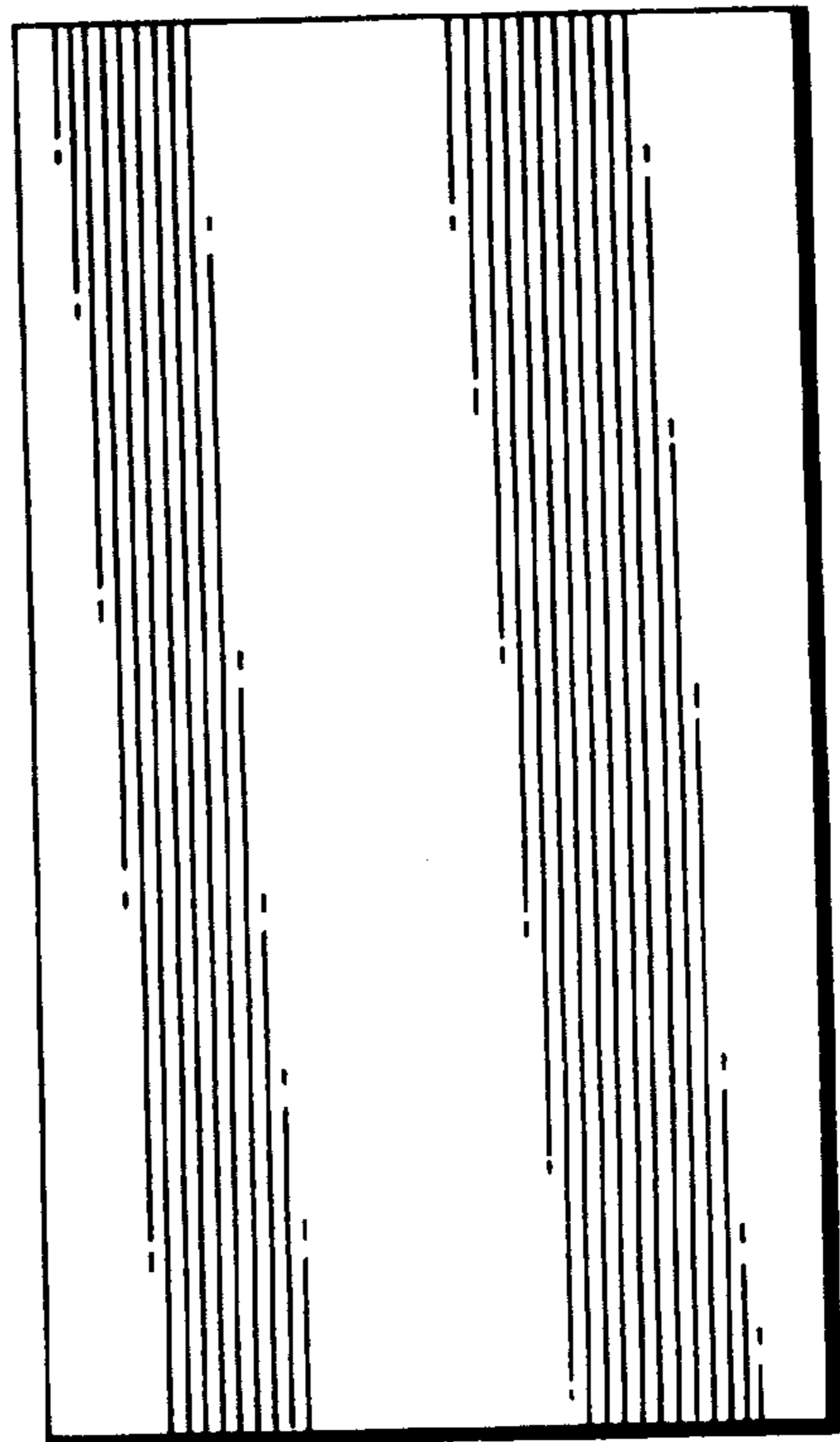

FIG. 6.

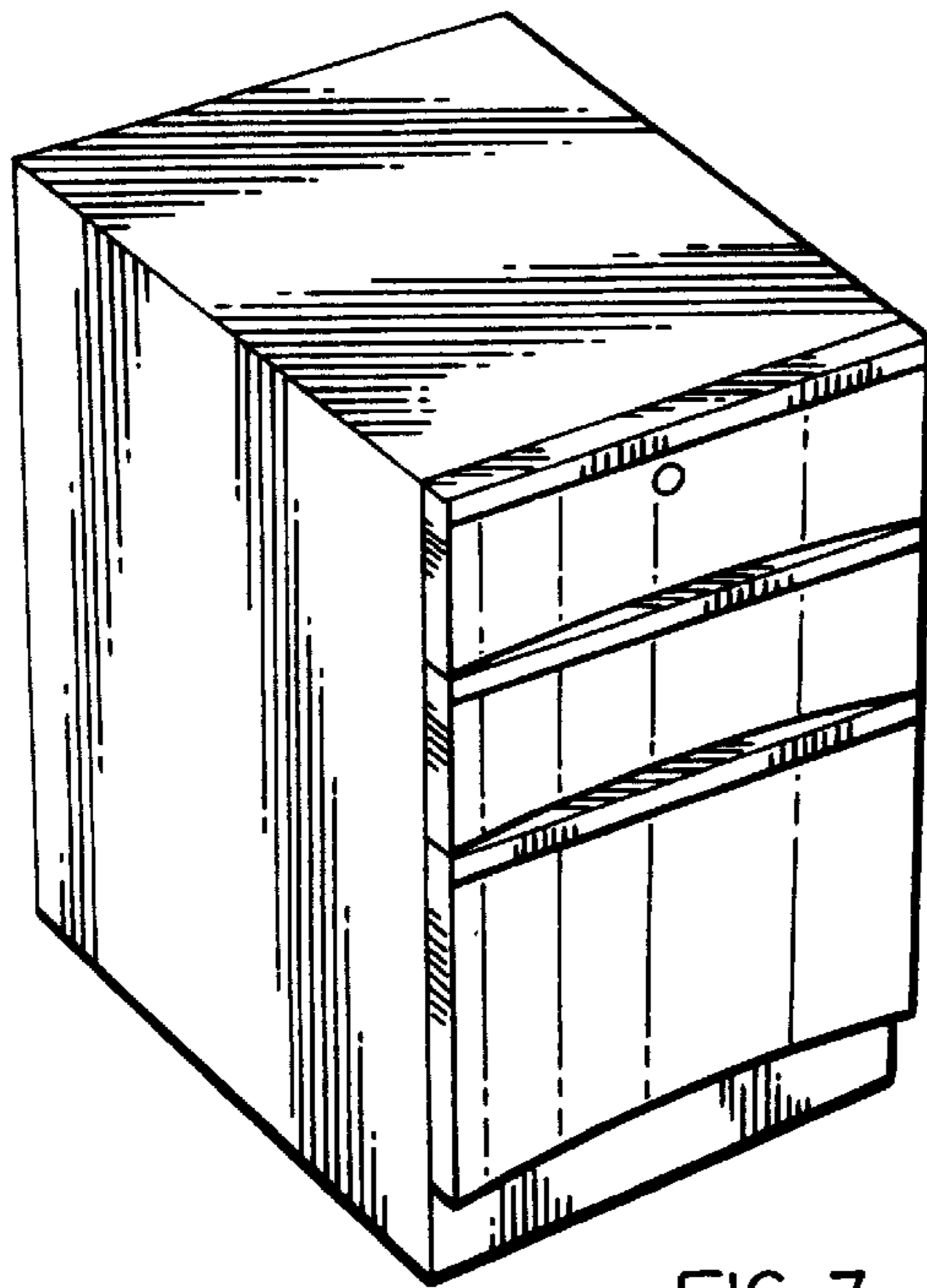

FIG. 7.

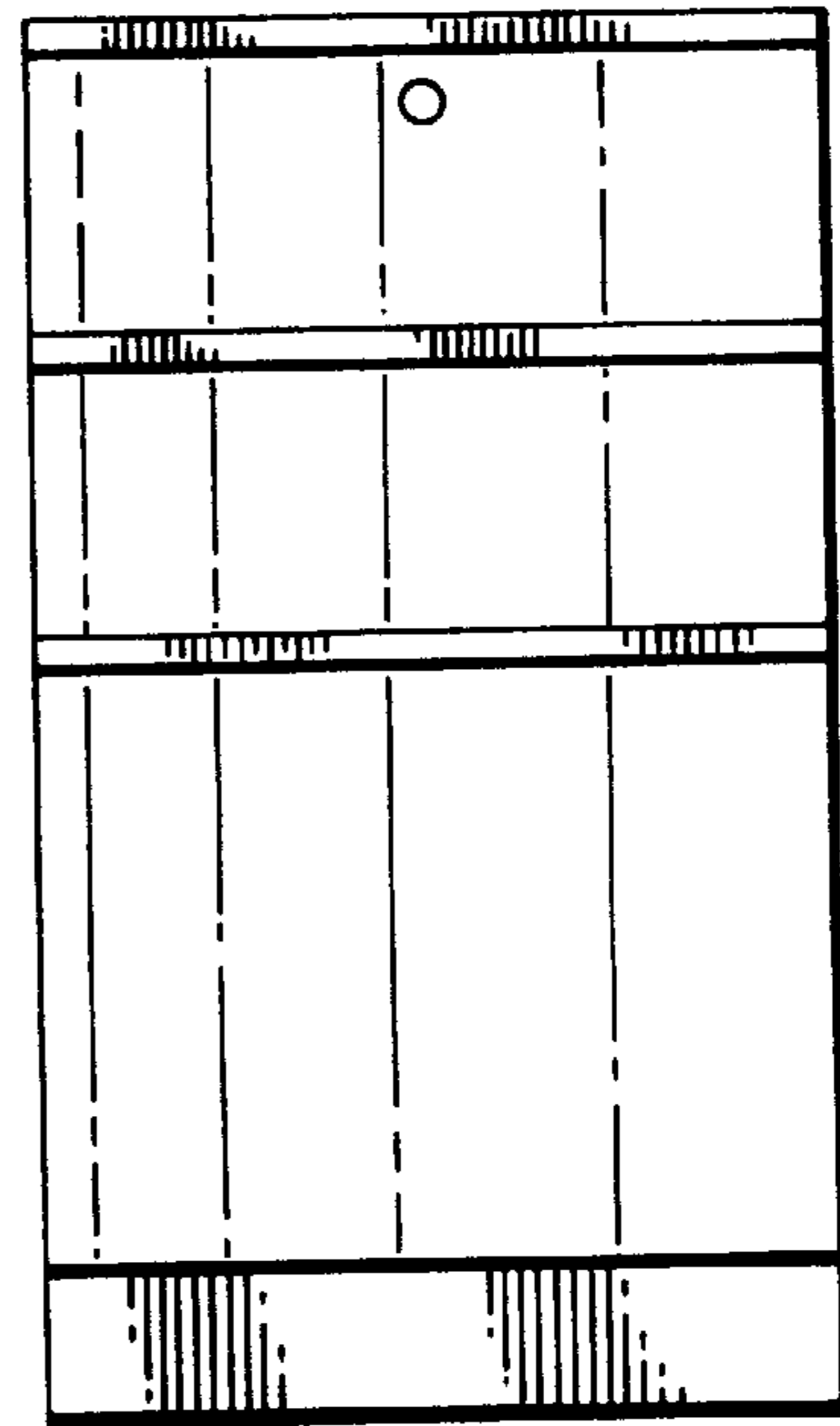

FIG. 8.

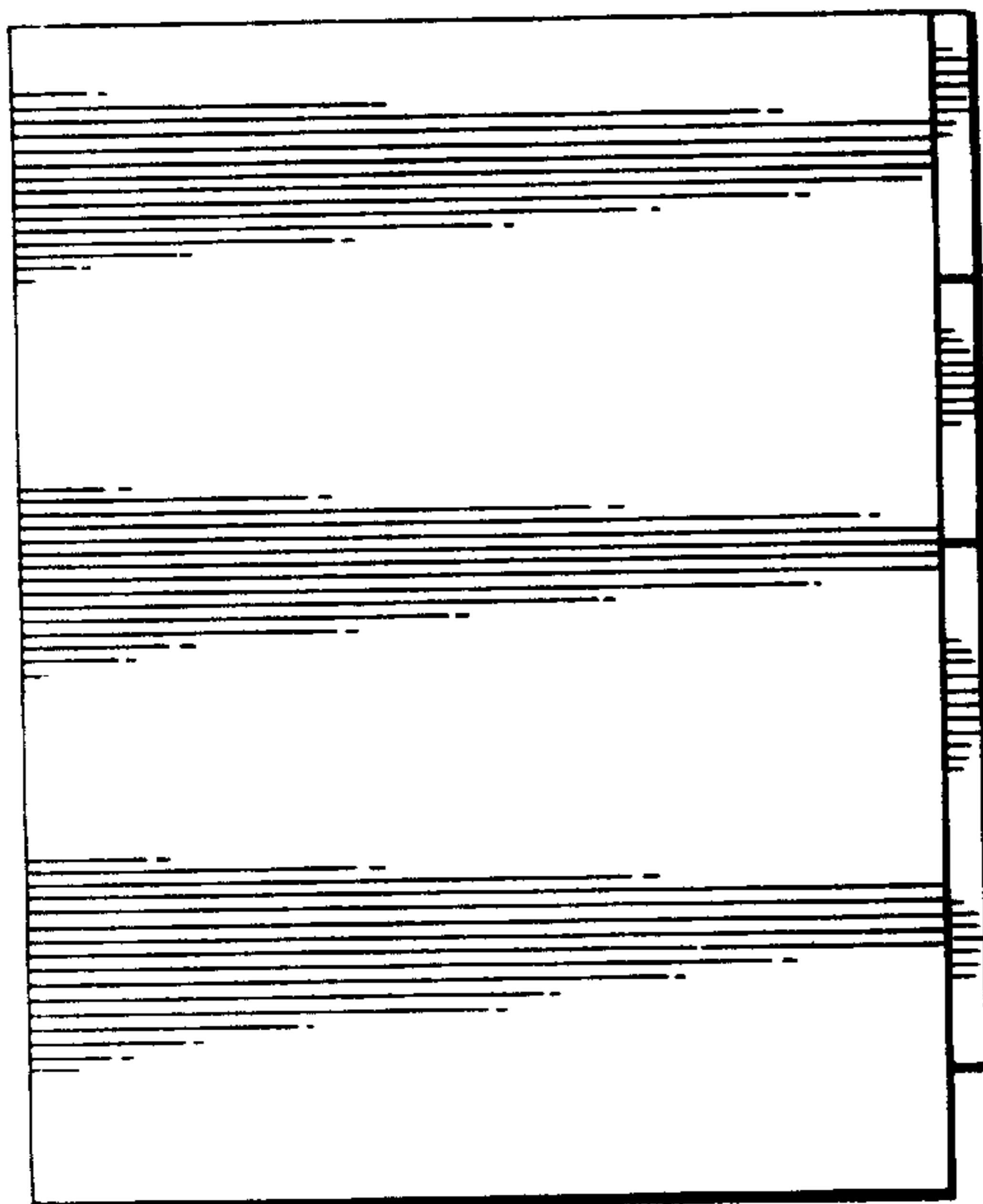

FIG. 9.

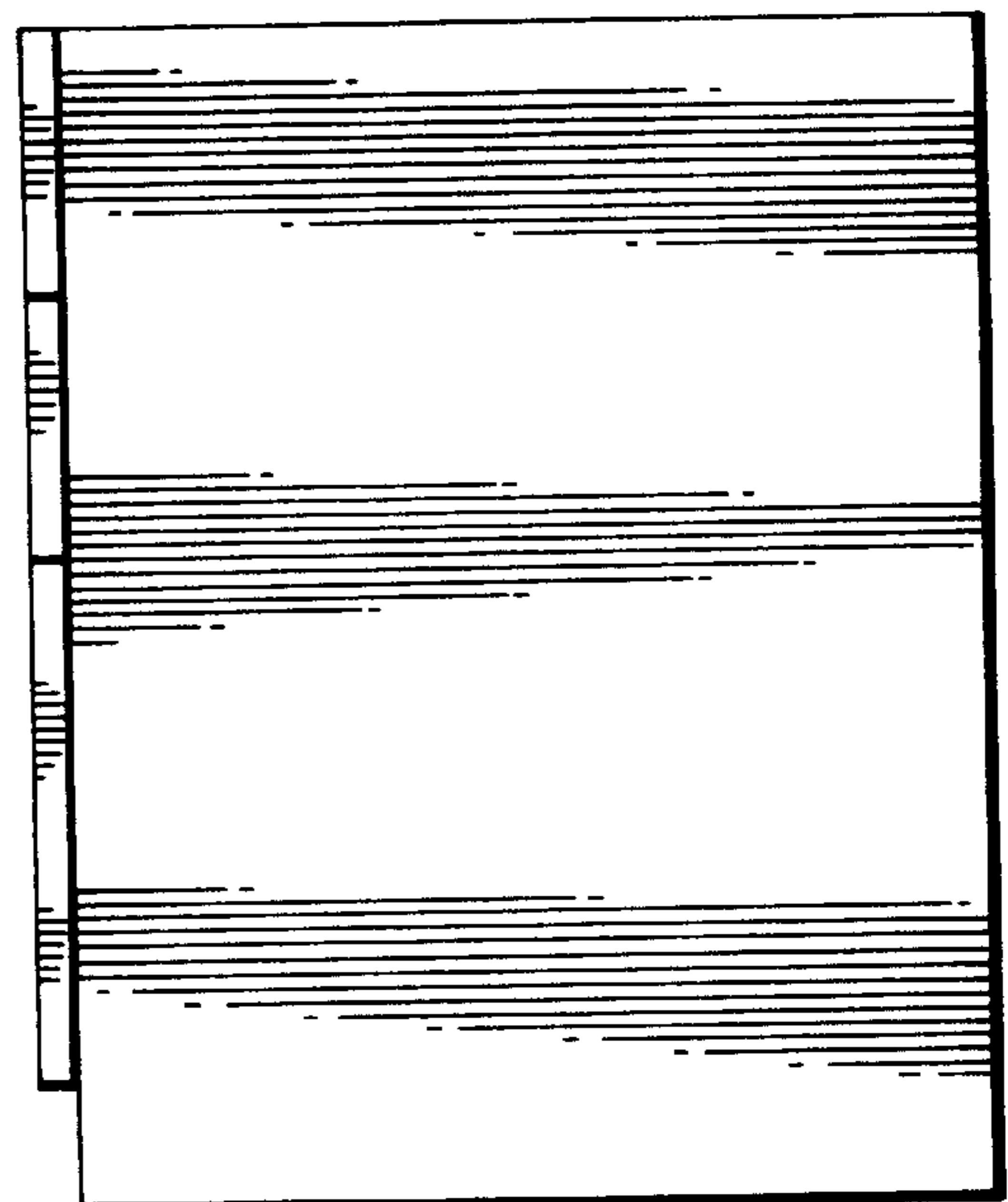

FIG. 10.

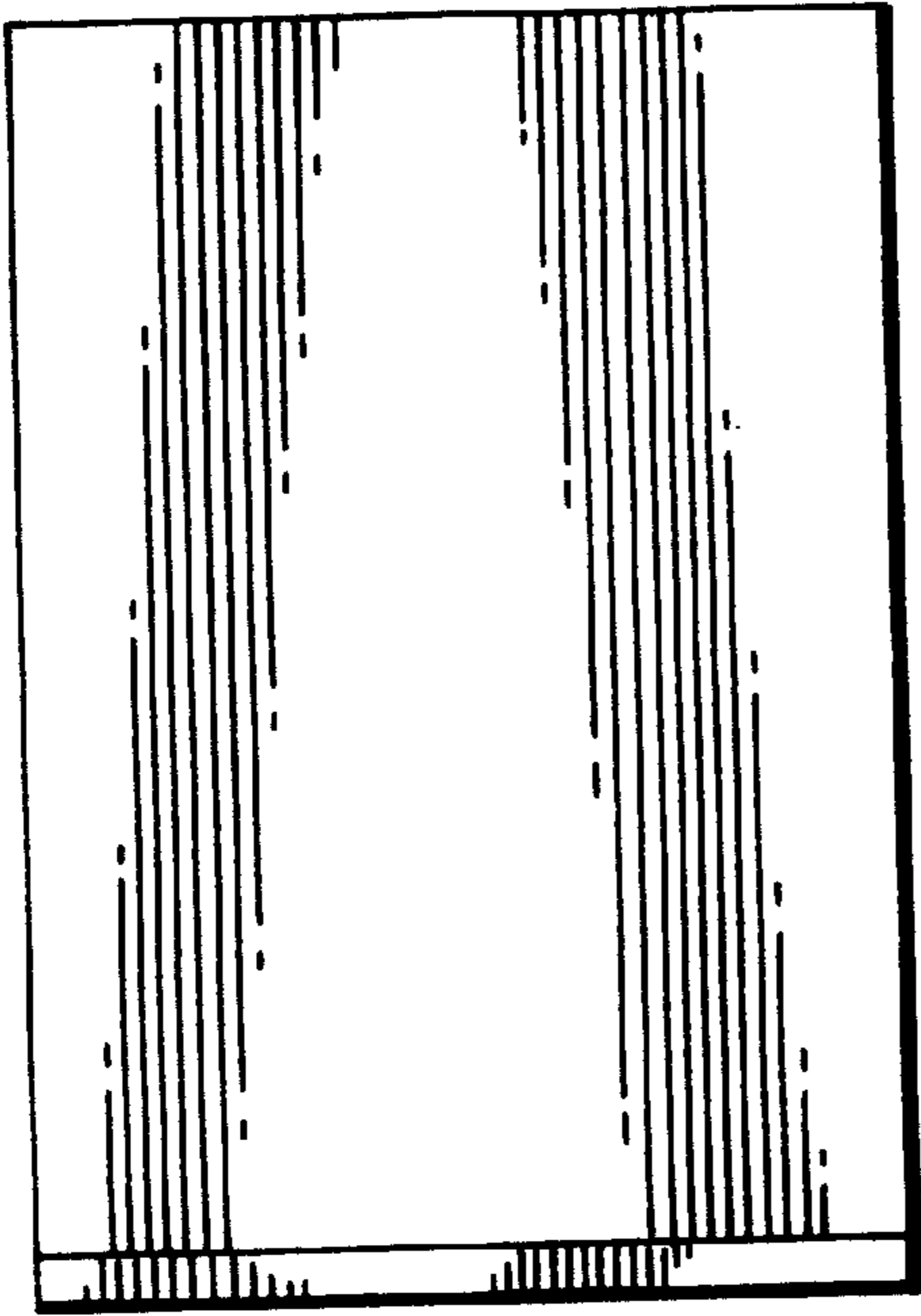

FIG. 11.

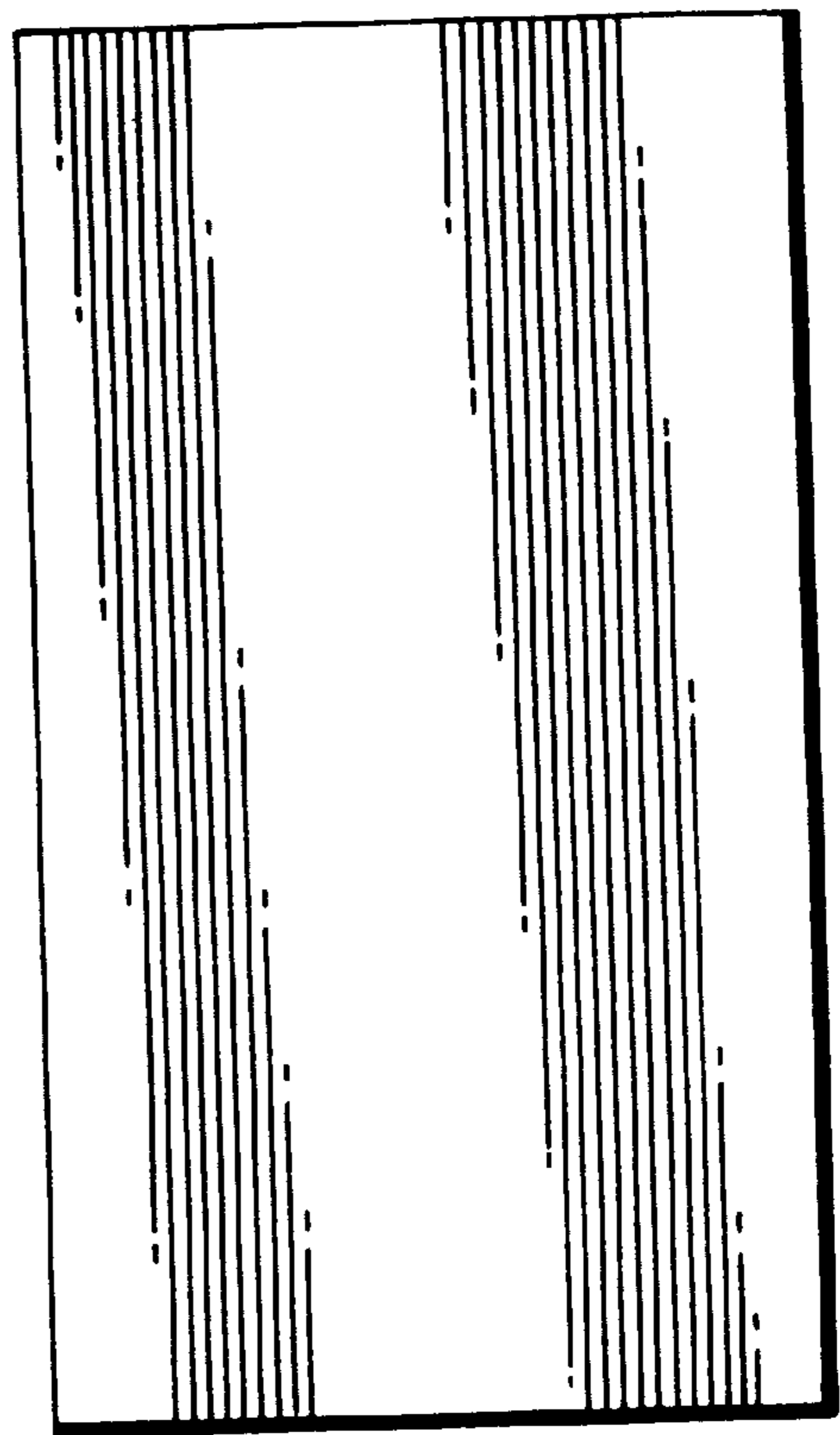

FIG. 12.

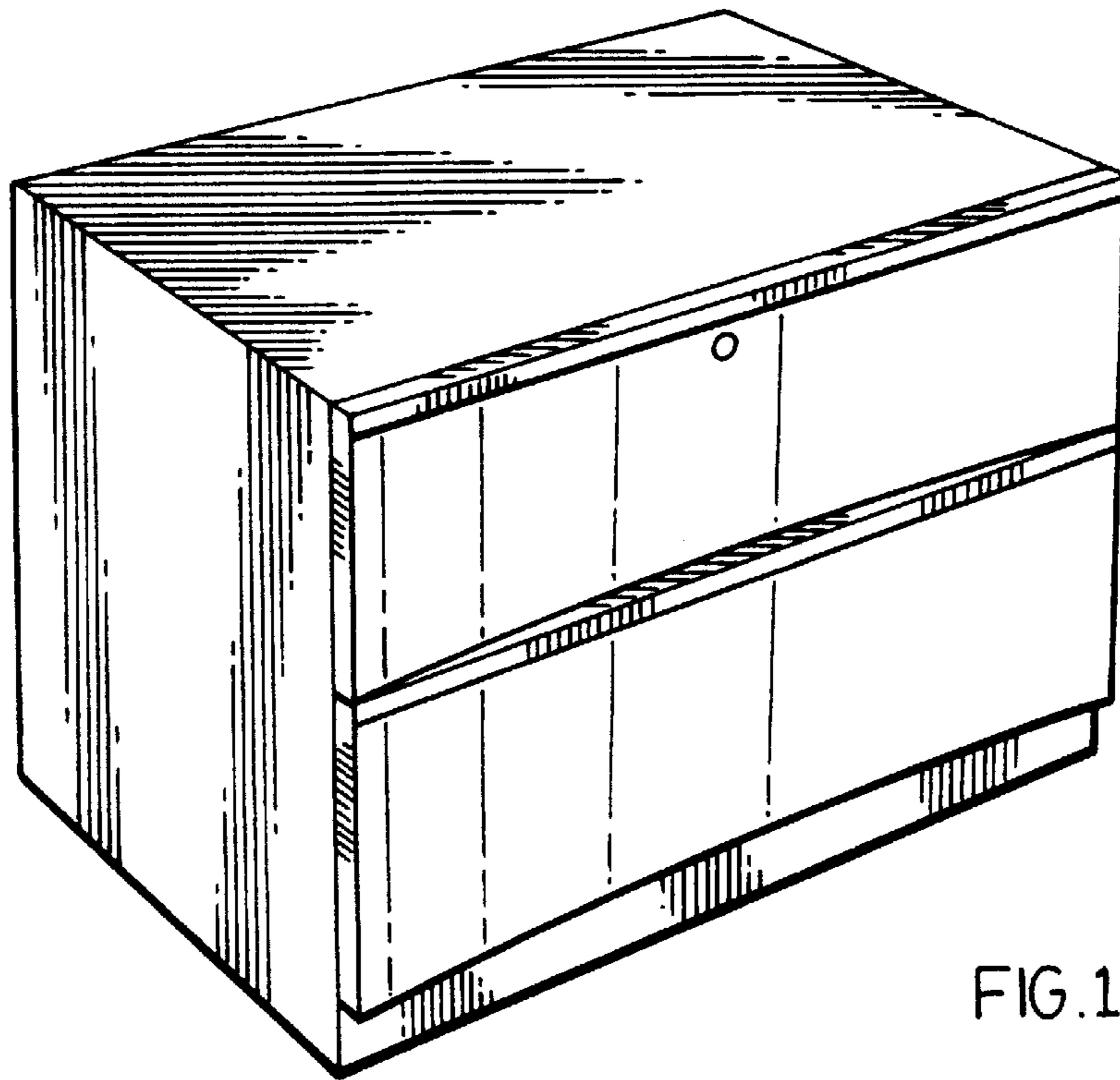
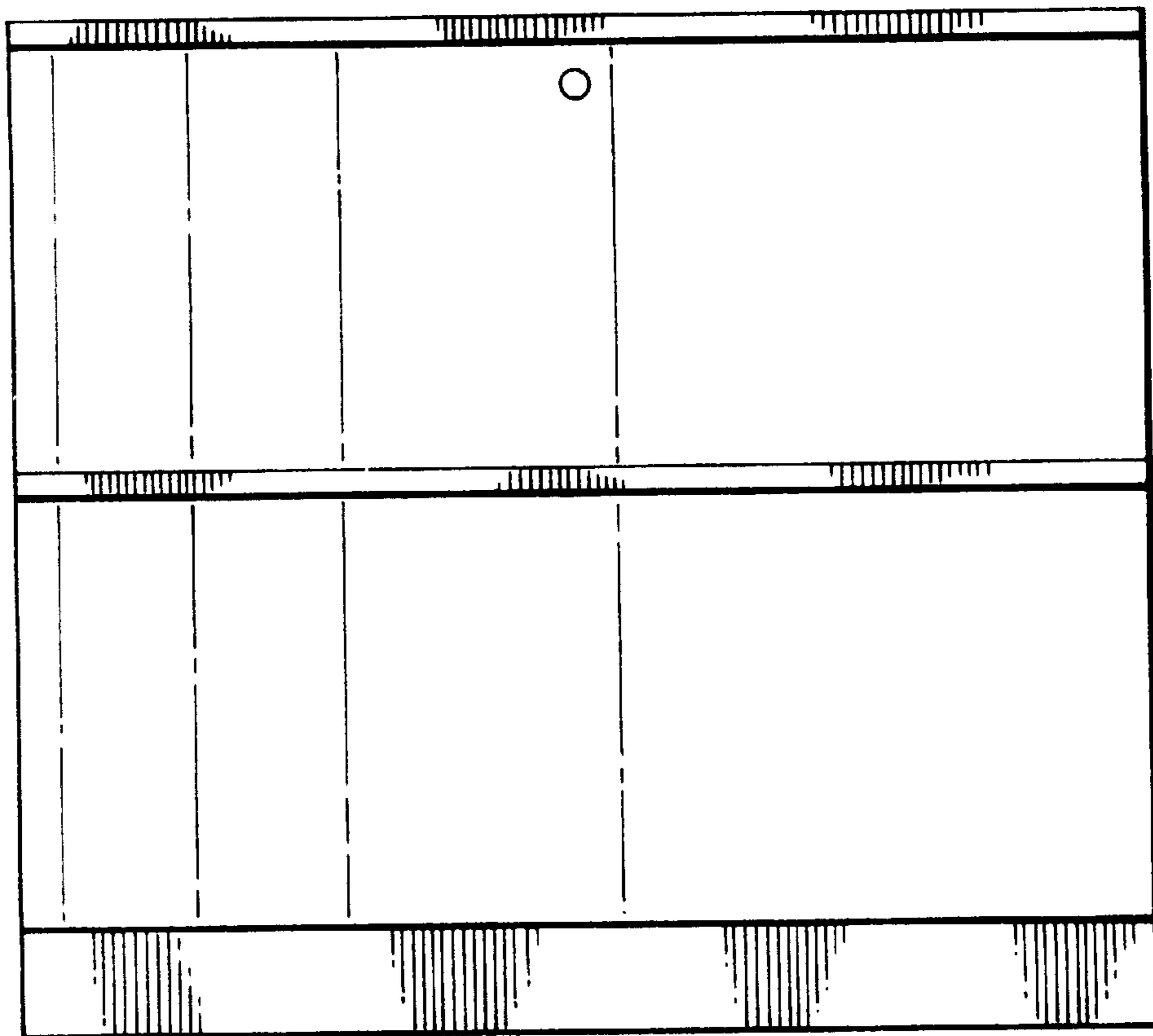

FIG. 13.

FIG. 14.



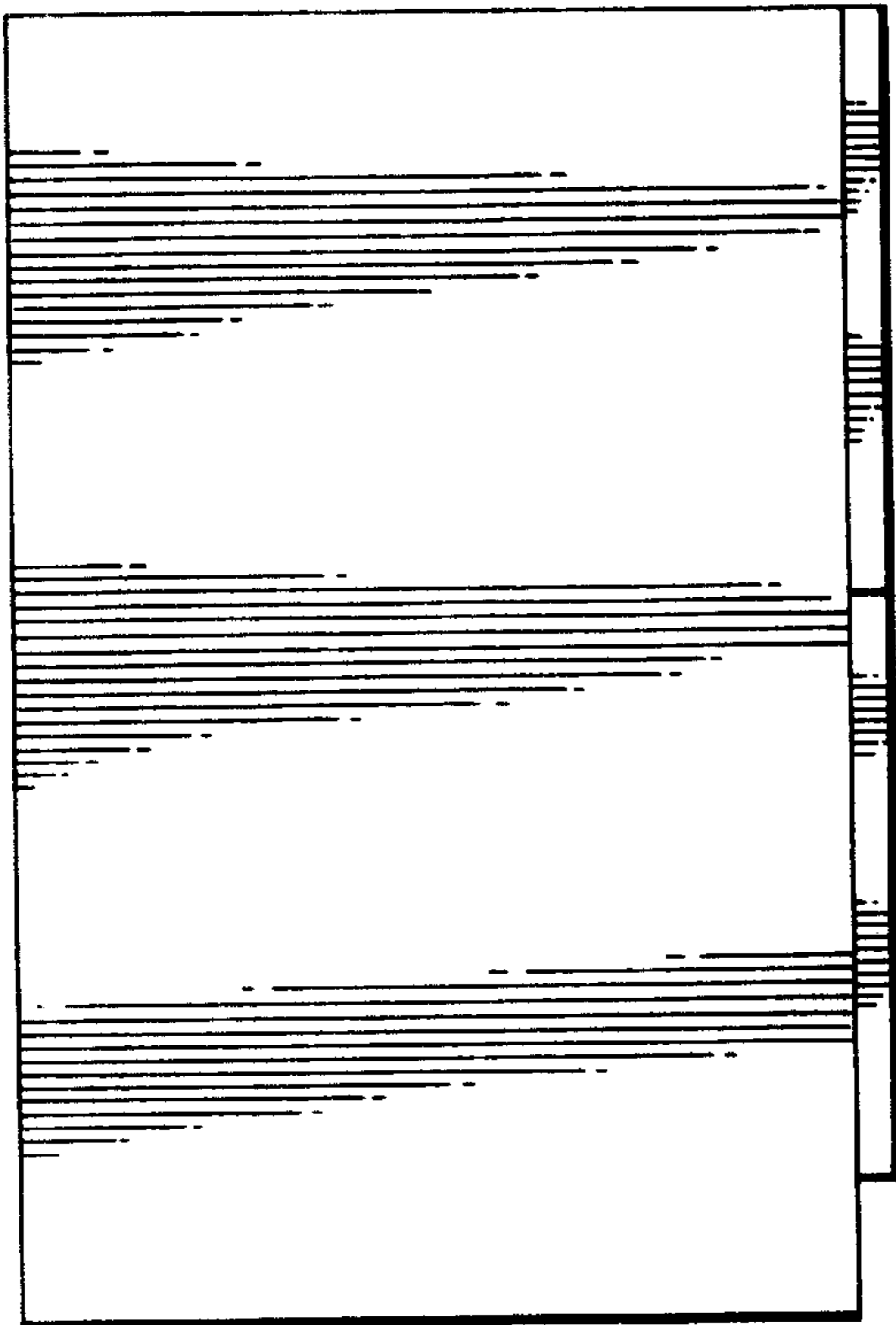

FIG. 15.

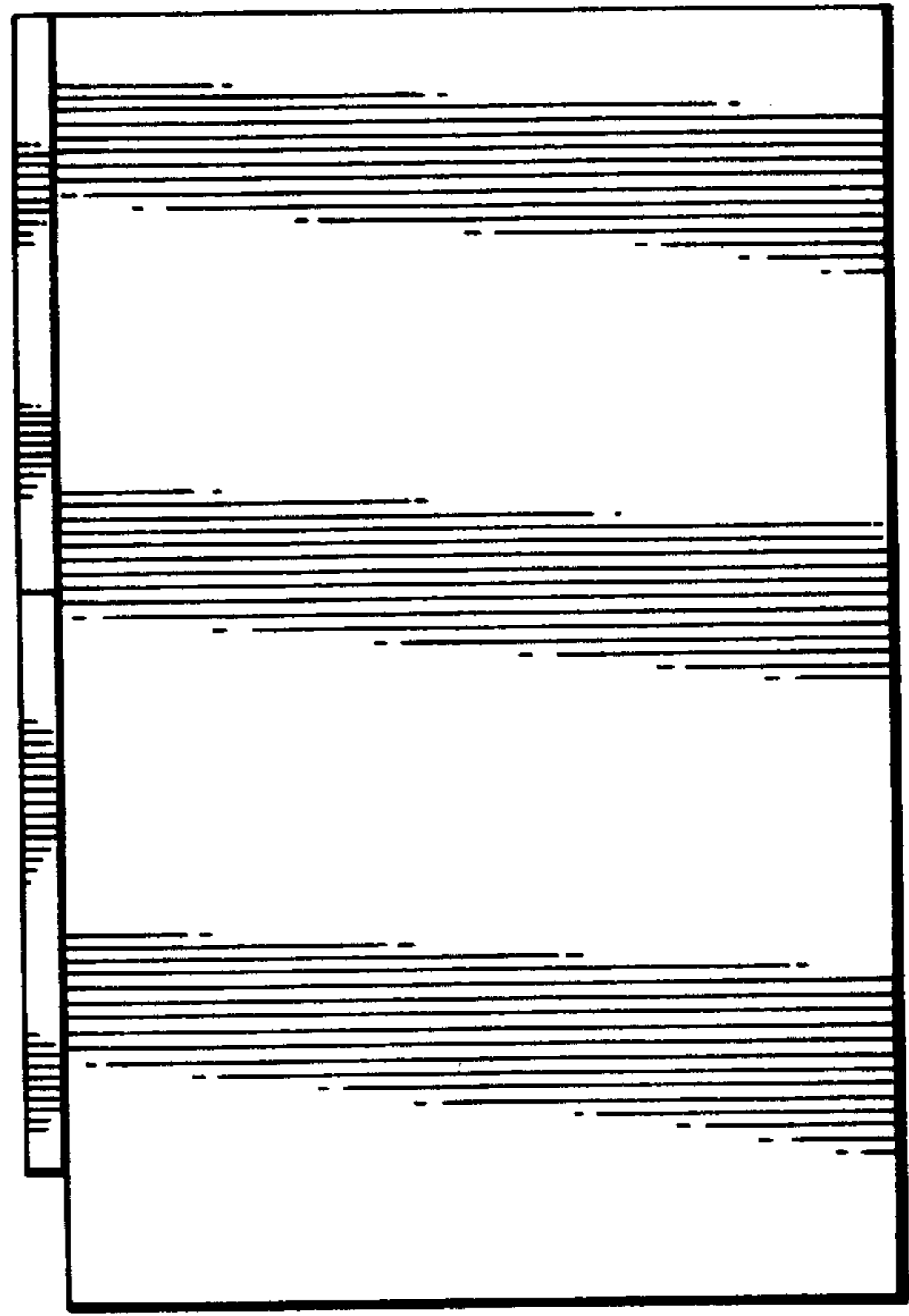

FIG. 16.

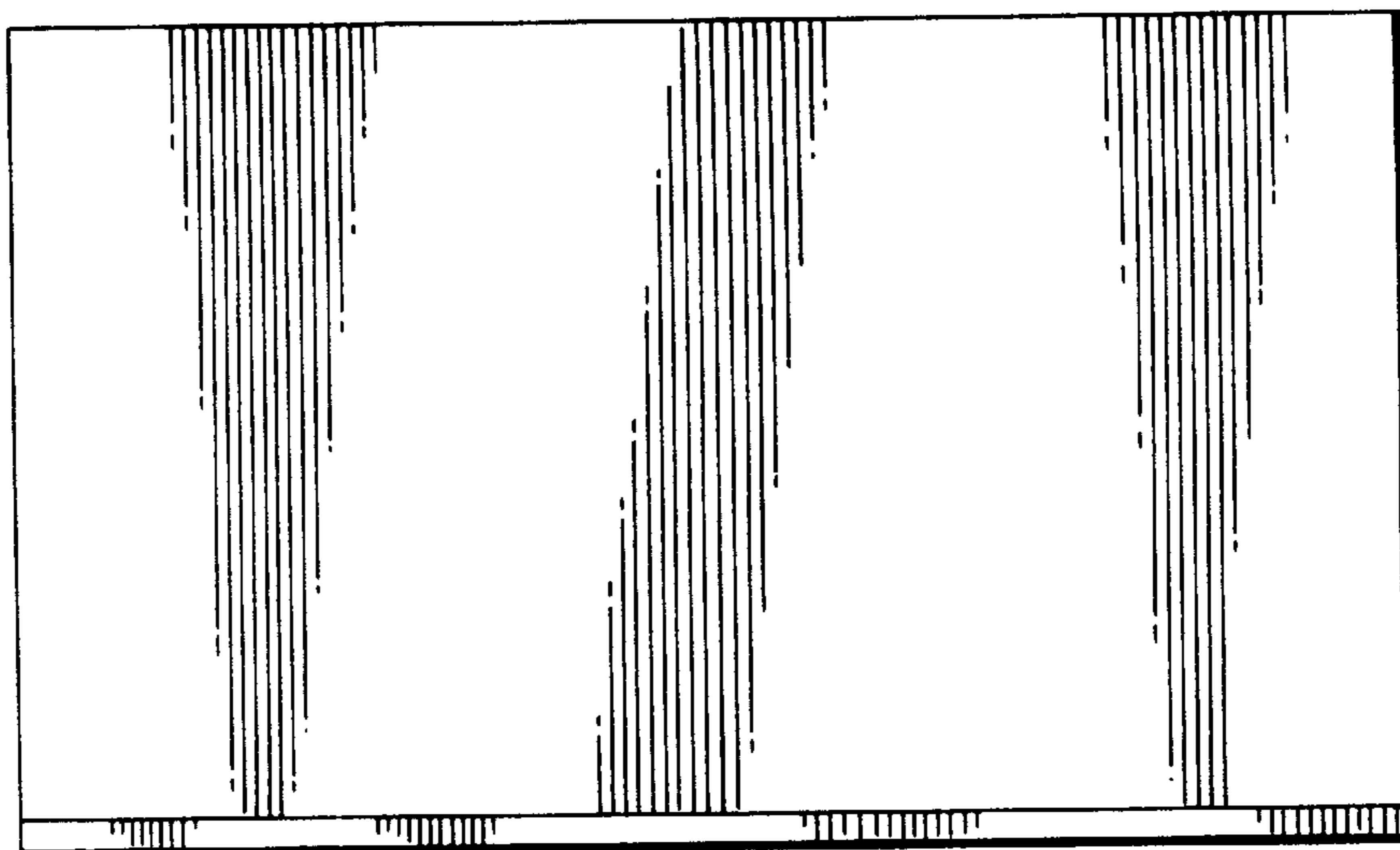

FIG. 17.

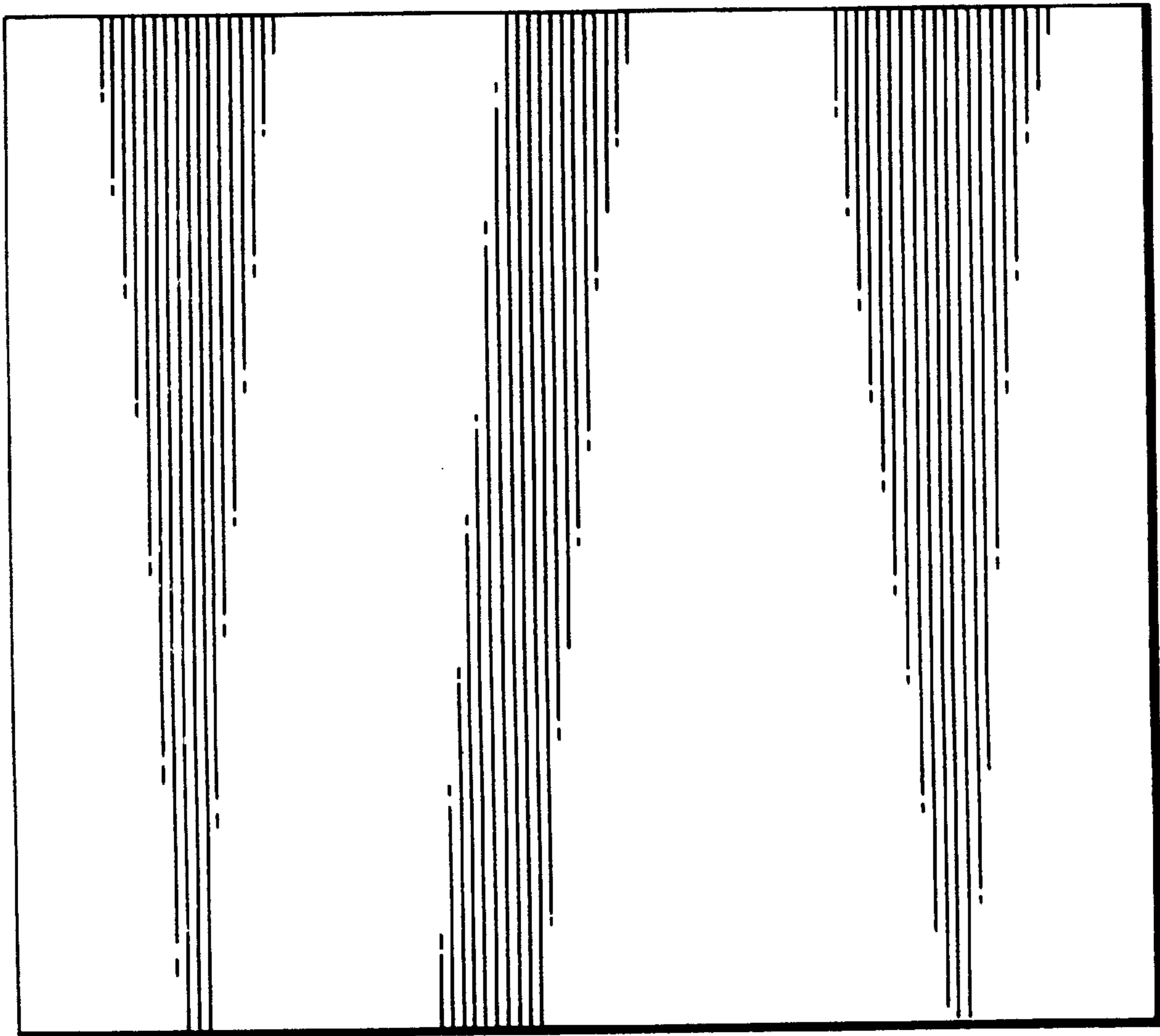

FIG. 18