



US00D433147S

United States Patent [19]
Florkey et al.

[11] **Patent Number: Des. 433,147**

[45] **Date of Patent: ** Oct. 31, 2000**

[54] **STERILIZER**

[75] Inventors: **Edward J. Florkey**, Vandalia; **Rainer Teufel**, Columbus; **Jon Wells**, New Breman, all of Ohio

[73] Assignee: **Midmark Corporation**, Versailles, Ohio

[**] Term: **14 Years**

[21] Appl. No.: **29/104,089**

[22] Filed: **Apr. 28, 1999**

[51] **LOC (7) Cl.** **24-01**

[52] **U.S. Cl.** **D24/217**

[58] **Field of Search** D24/217; 422/300, 422/301, 292, 295, 298, 297, 302, 305

[56] **References Cited**

U.S. PATENT DOCUMENTS

| | | | | |
|------------|---------|------------------|-------|---------|
| D. 247,308 | 2/1978 | Truette | | D24/217 |
| D. 264,123 | 4/1982 | Brendgord et al. | . | |
| D. 264,124 | 4/1982 | Brendgord et al. | . | |
| D. 330,771 | 11/1992 | Chaney et al. | . | |
| D. 347,696 | 6/1994 | Tominaga | | D24/217 |
| D. 404,827 | 1/1999 | Thoburn | | D24/217 |
| 3,814,901 | 6/1974 | Morhack | . | |
| 3,826,612 | 7/1974 | Black | . | |

| | | | |
|-----------|--------|-------------------|---|
| 4,261,950 | 4/1981 | Bainbridge et al. | . |
| 4,426,358 | 1/1984 | Johansson | . |
| 4,848,031 | 7/1989 | Yamagishi et al. | . |
| 4,951,693 | 8/1990 | Archambault | . |
| 5,223,229 | 6/1993 | Brucker | . |

OTHER PUBLICATIONS

SciCan; STATIM Cassette Autoclave, 1997.
SciCan; STATIM 5000 Comparison, 1997.
Tuttner Autoclaves from Alfa Medical May 1998.

Primary Examiner—Ian Simmons
Attorney, Agent, or Firm—Biebel & French

[57] **CLAIM**

The ornamental design for a sterilizer, as shown and described.

DESCRIPTION

FIG. 1 is a perspective view of the sterilizer of the present invention;
FIG. 2 is a right side elevational view thereof;
FIG. 3 is a left side elevational view thereof;
FIG. 4 is a front elevational view thereof;
FIG. 5 is a rear elevational view thereof;
FIG. 6 is a top plan view thereof; and,
FIG. 7 is a bottom plan view thereof.

1 Claim, 7 Drawing Sheets

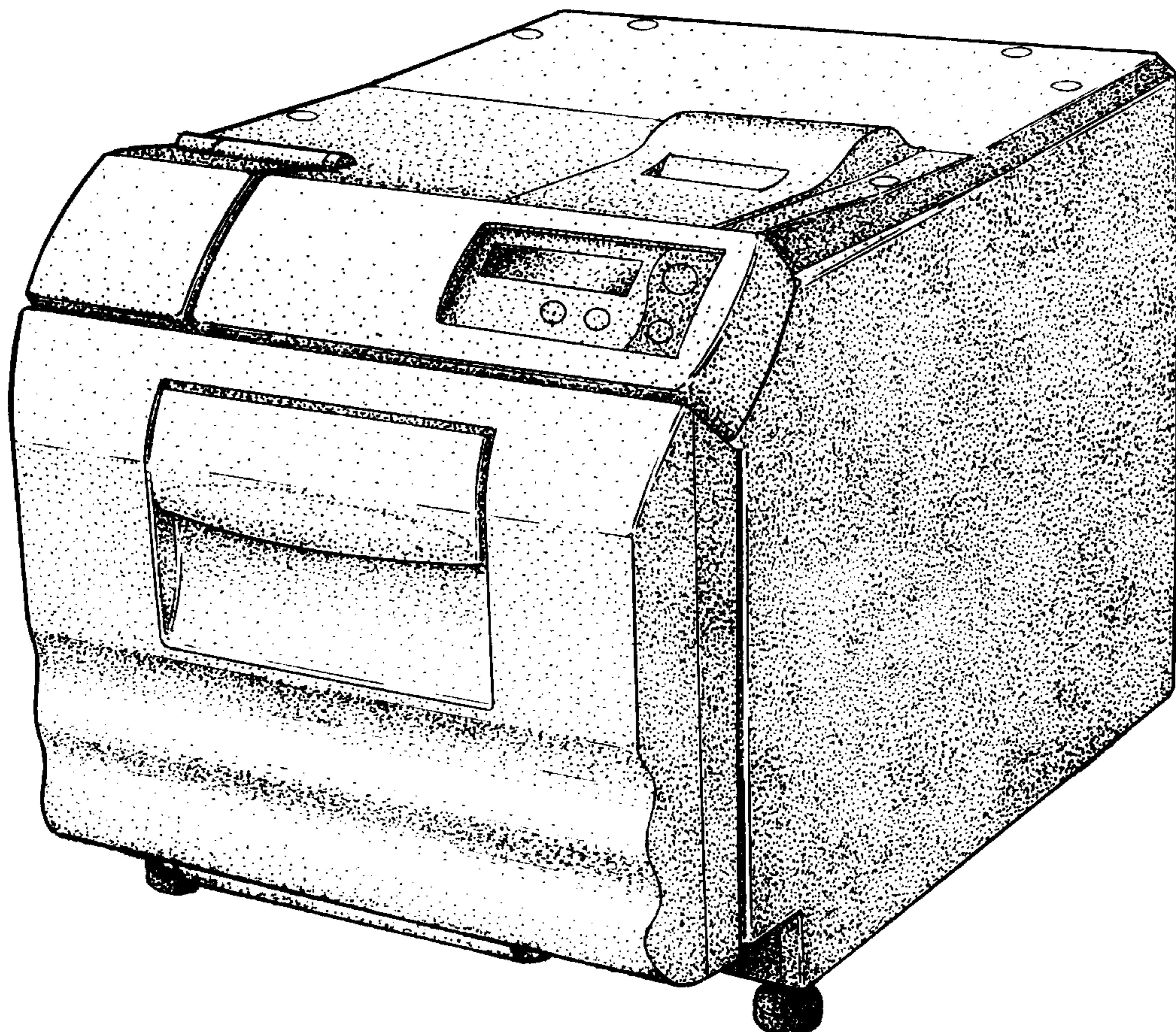

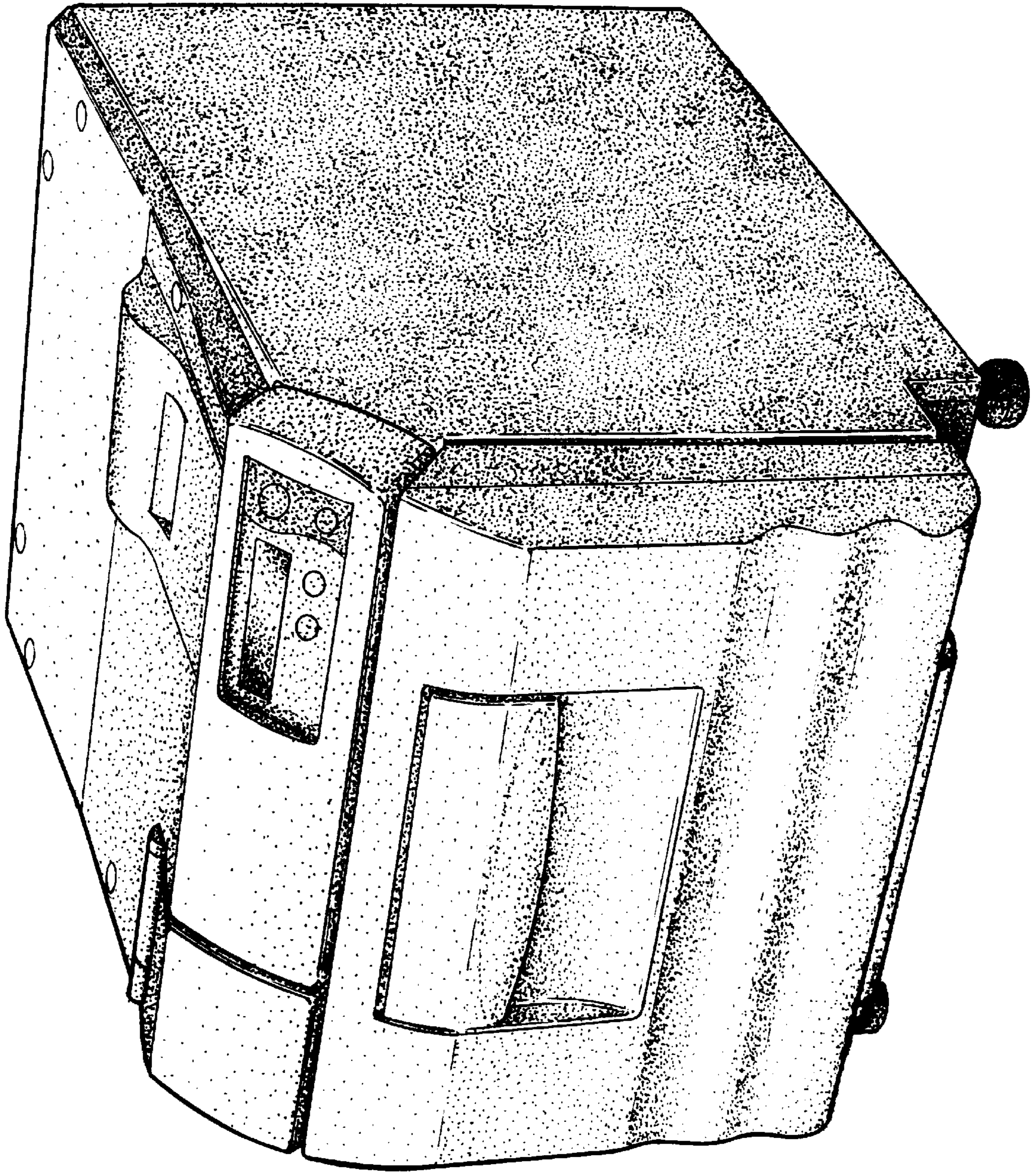

FIG-1

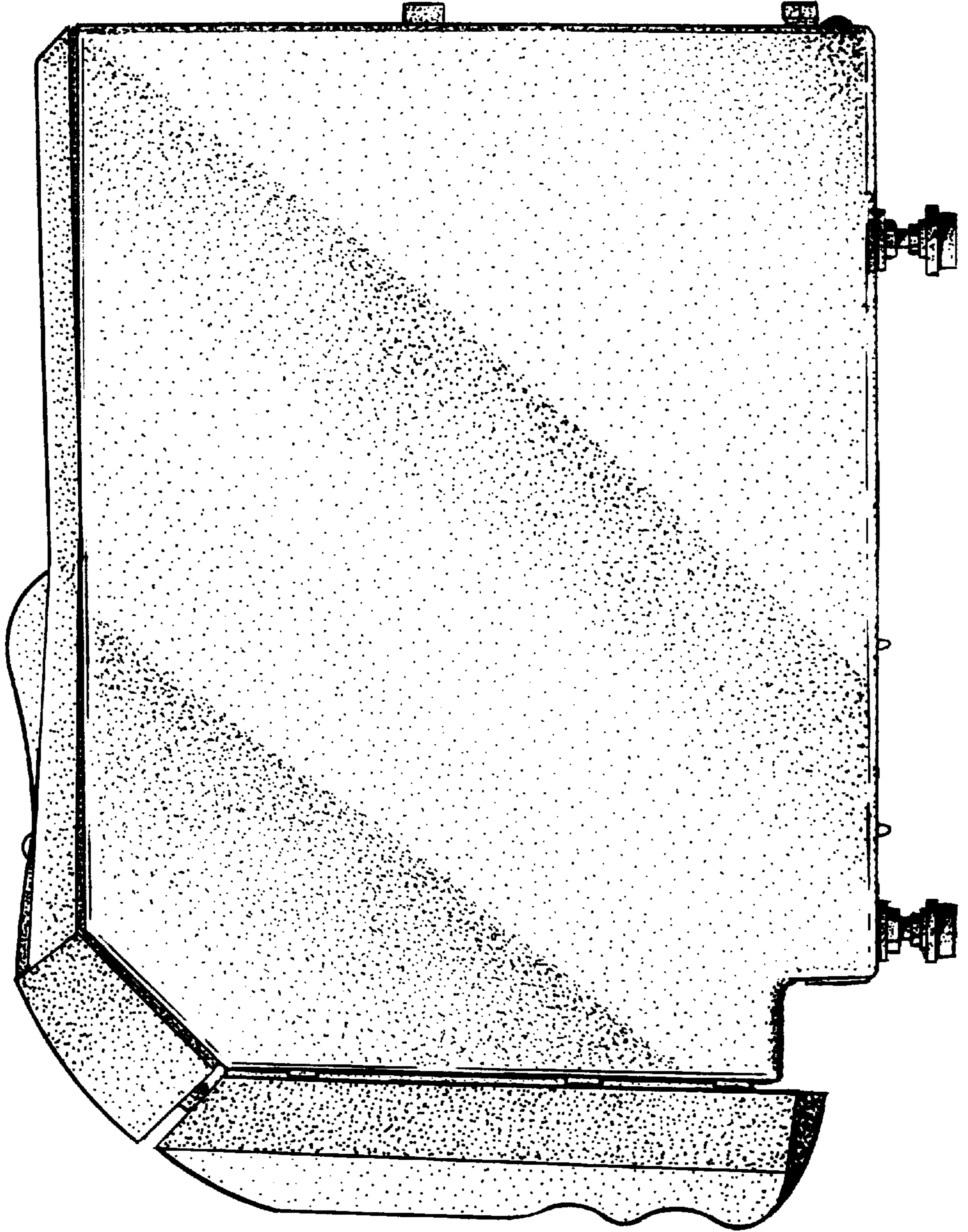

FIG - 2

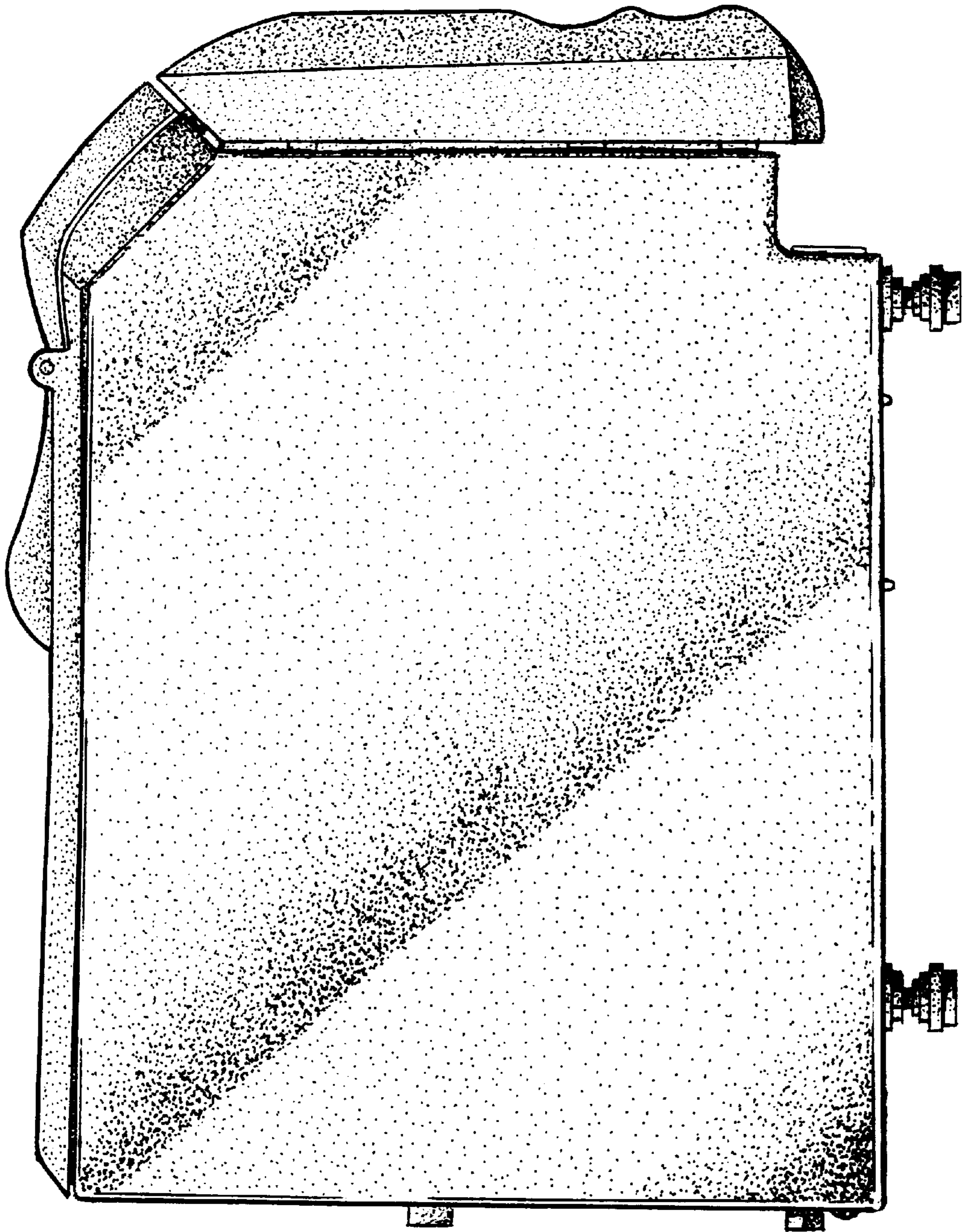

FIG-3

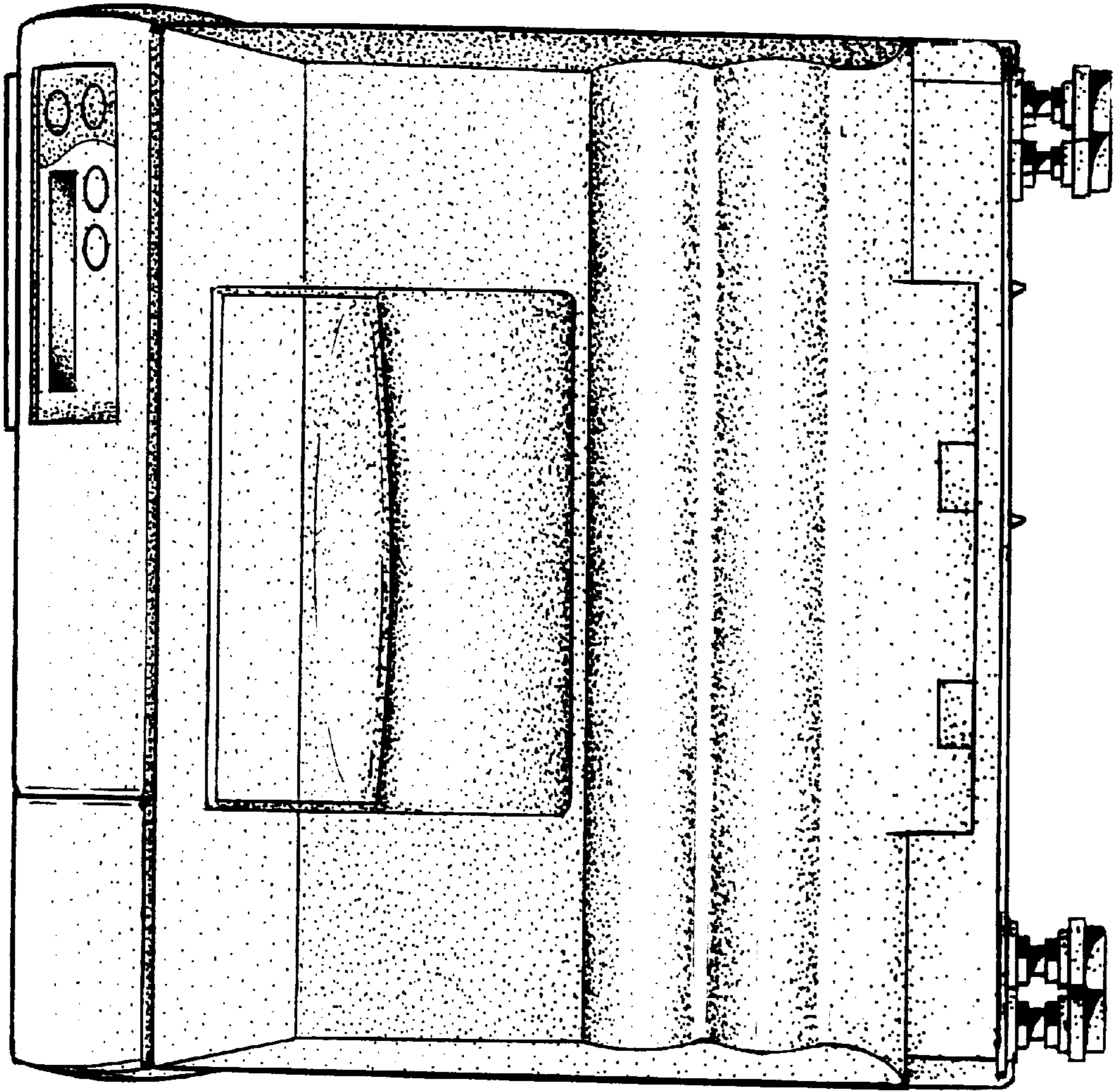

FIG-4

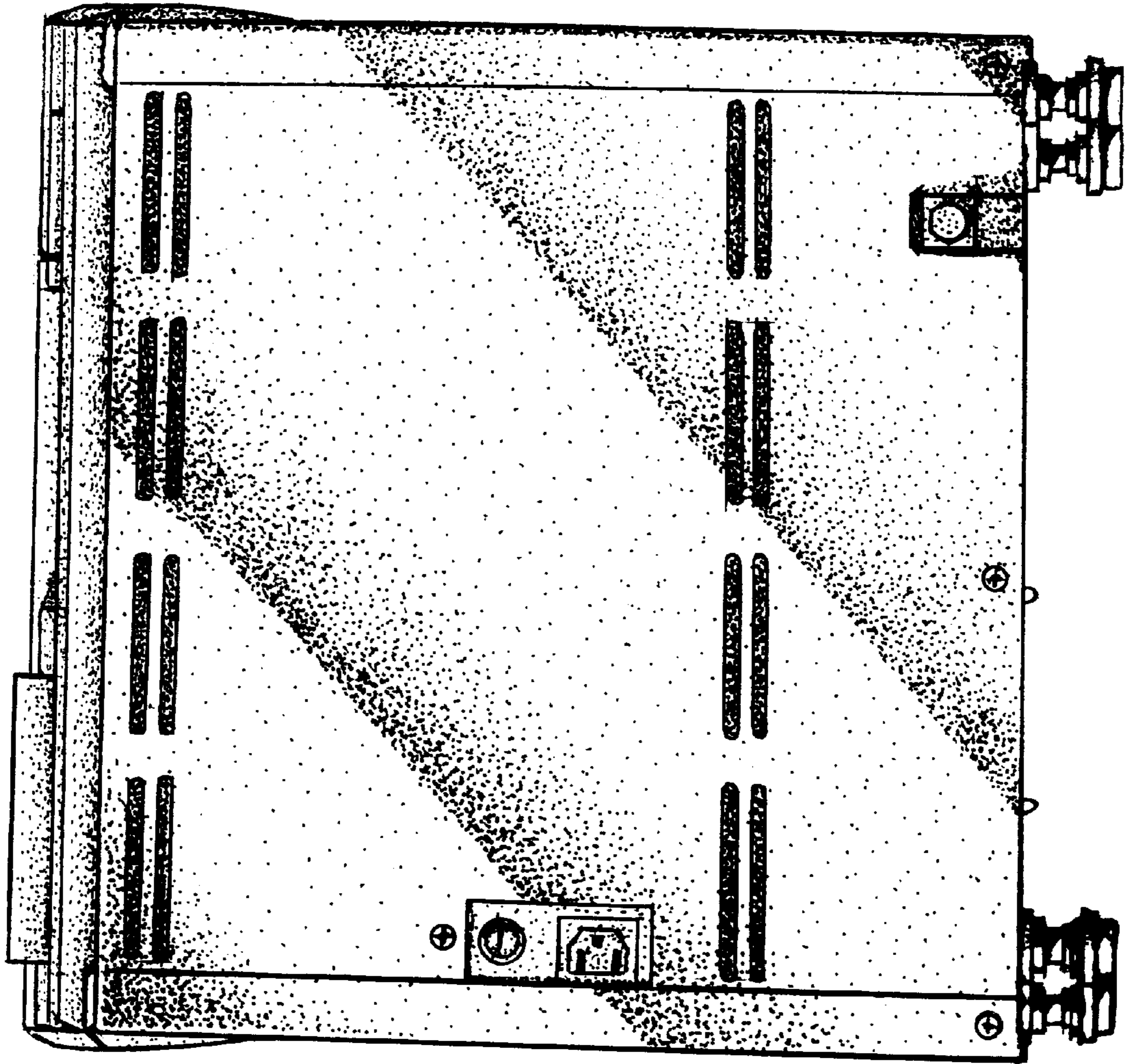

FIG-5

FIG - 6

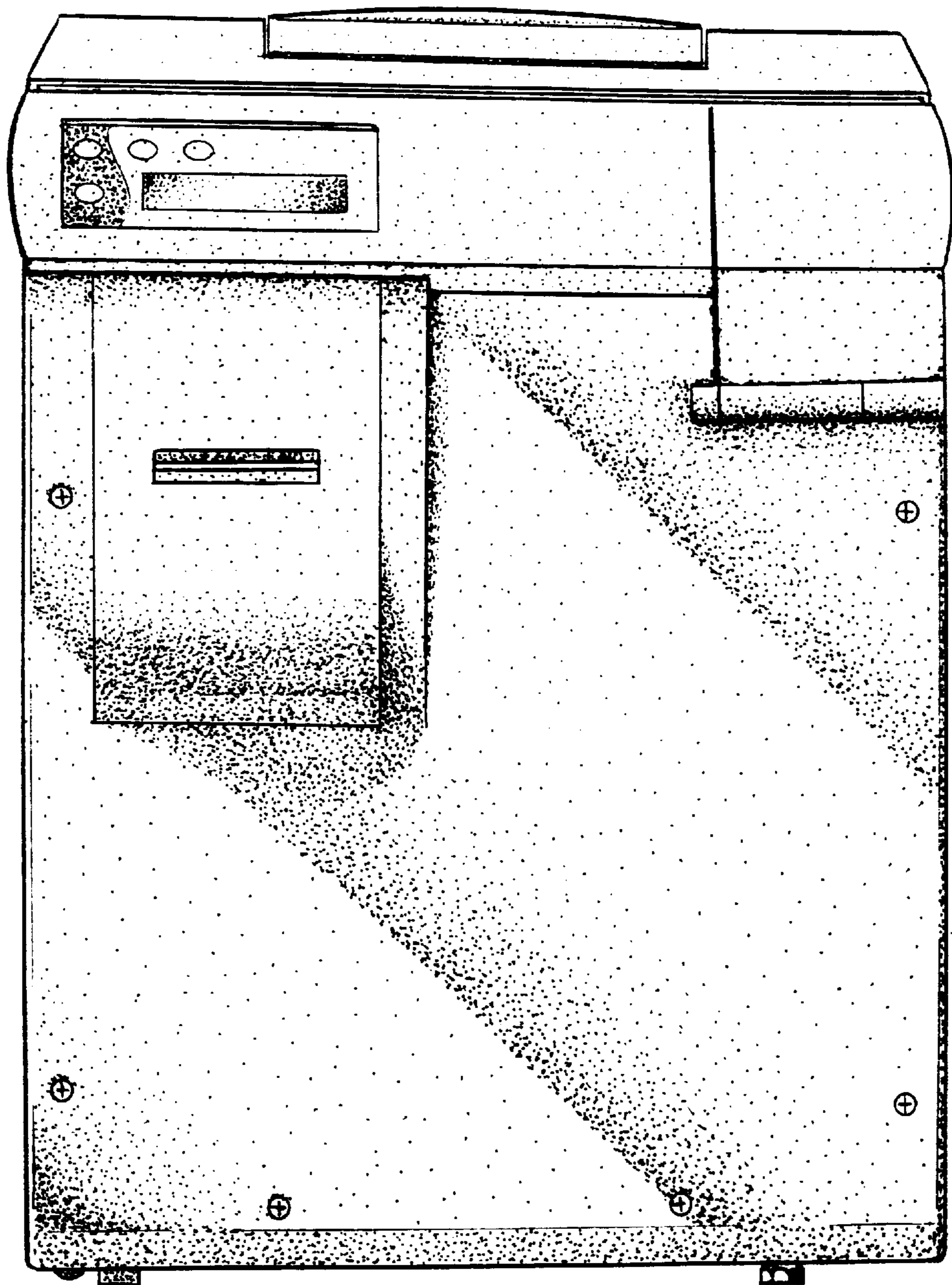

FIG - 7

