



US00D433137S

United States Patent [19]

Pollock et al.

[11] **Patent Number: Des. 433,137**

[45] **Date of Patent: ** Oct. 31, 2000**

[54] **DENTAL SCALER**

6,030,212 2/2000 Schuman et al. 433/80

[75] Inventors: **David P. Pollock**, York; **Kent D. Russell**, Seven Valleys; **Kevin K. Lint**, York, all of Pa.; **Eric Ping Pang Chan**; **Jeffrey F. Miller**, both of New York, N.Y.

Primary Examiner—Antoine Duval Davis
Attorney, Agent, or Firm—Dale R. Lovercheck; James B. Bieber

[73] Assignee: **Dentsply Research & Development Corp.**, Los Angeles, Calif.

[57] **CLAIM**
The ornamental design for a dental scaler, as shown and described.

[**] Term: **14 Years**

DESCRIPTION

[21] Appl. No.: **29/112,507**

FIG. 1 is a frontal perspective view of a dental scaler in accordance with the invention.
FIG. 2 is a front view of the dental scaler shown in FIGS. 1 through 7.
FIG. 3 is a rear view of the dental scaler shown in FIGS. 1 through 7.
FIG. 4 is a side view of the dental scaler shown in FIGS. 1 through 7.
FIG. 5 is a side view of the dental scaler shown in FIGS. 1 through 7.
FIG. 6 is a top view of the dental scaler shown in FIGS. 1 through 7; and,
FIG. 7 is a bottom view of the dental scaler shown in FIGS. 1 through 7.

[22] Filed: **Oct. 18, 1999**

Related U.S. Application Data

[63] Continuation-in-part of application No. 29/111,327, Sep. 24, 1999, abandoned.

[51] **LOC (7) Cl.** **24-02**

[52] **U.S. Cl.** **D24/176**

[58] **Field of Search** D24/176, 147; 433/80-88; 604/259

The broken line showing is for illustrative purposes only and forms no part of the claimed design.

[56] References Cited

U.S. PATENT DOCUMENTS

D. 300,242 3/1989 Coulson D24/176

1 Claim, 6 Drawing Sheets

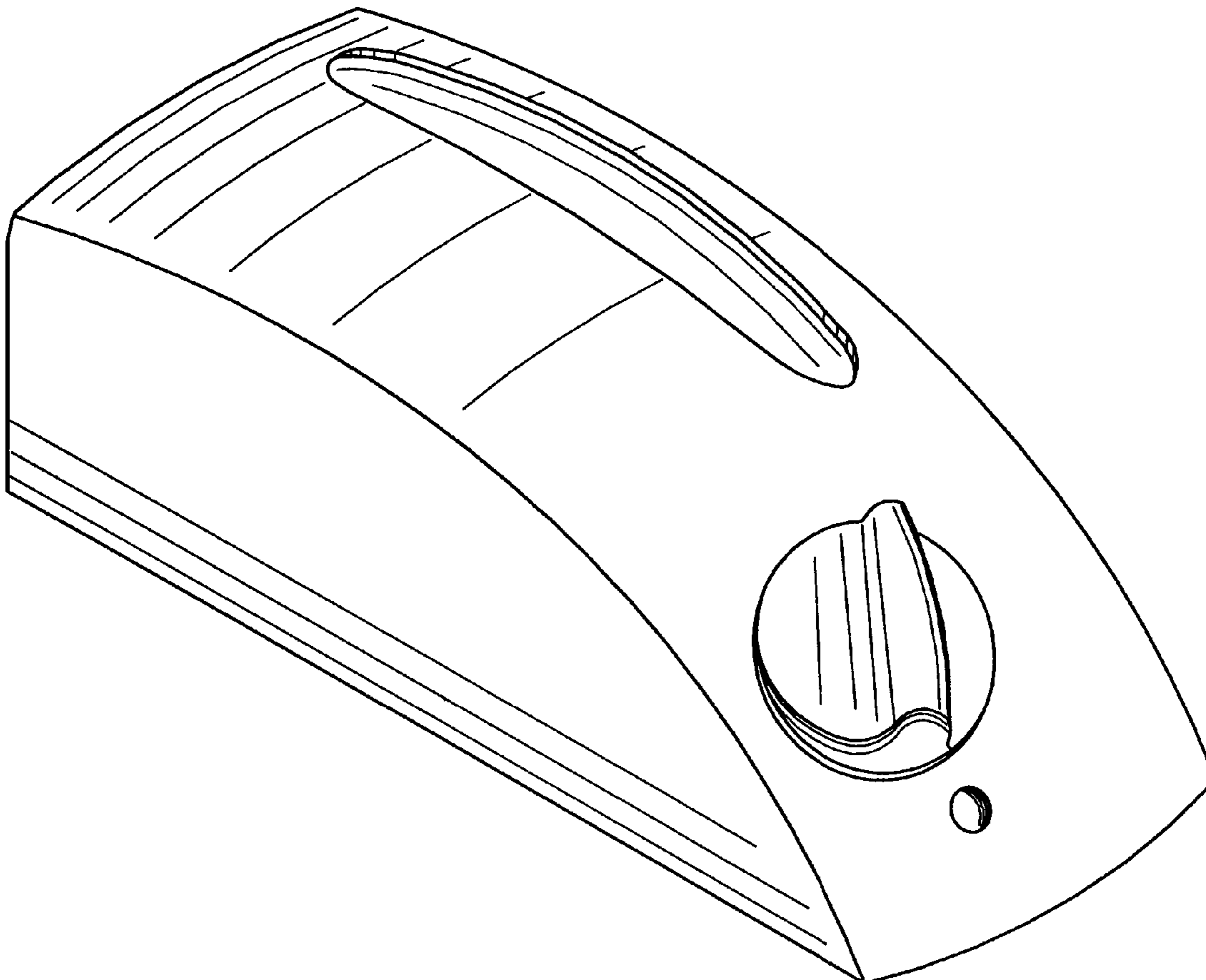

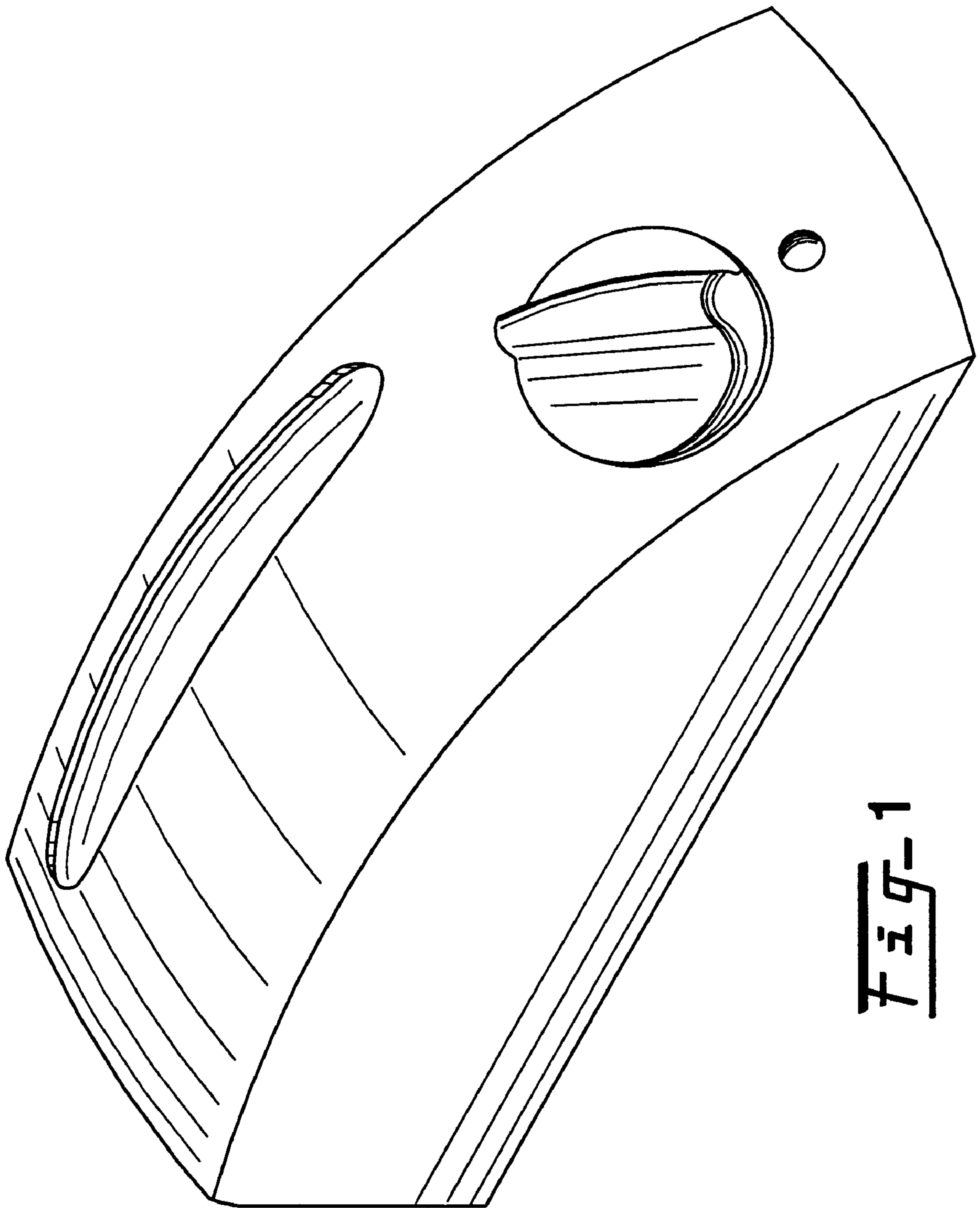

Fig-1

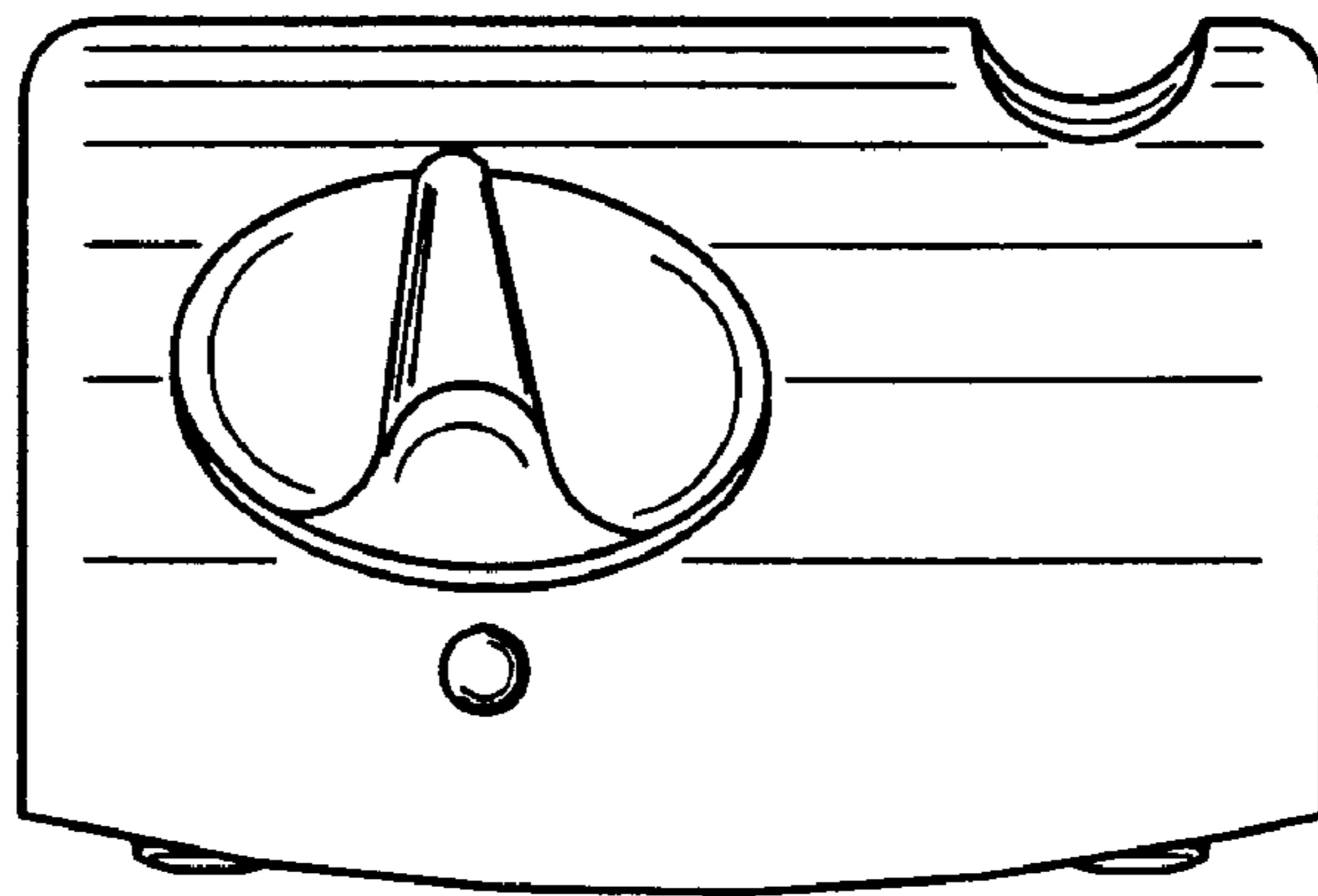

Fig-2

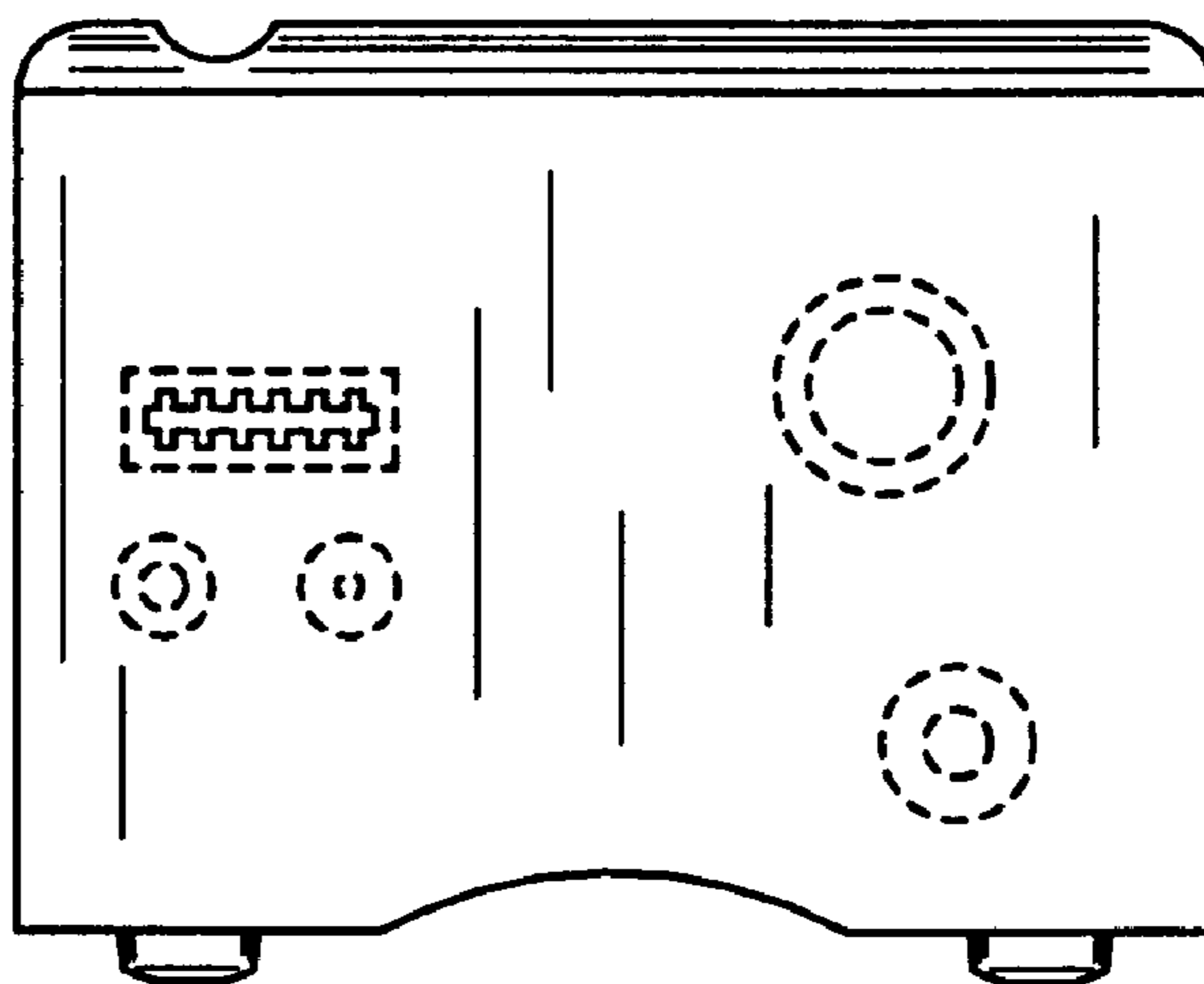

Fig-3

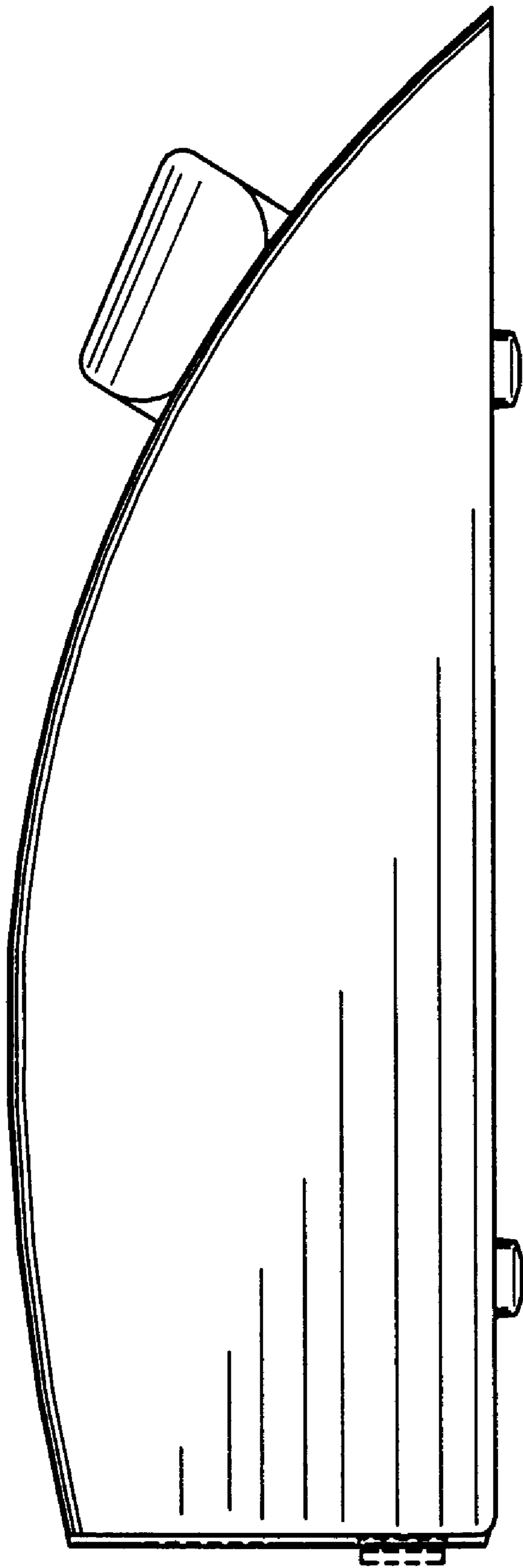

Fig-4

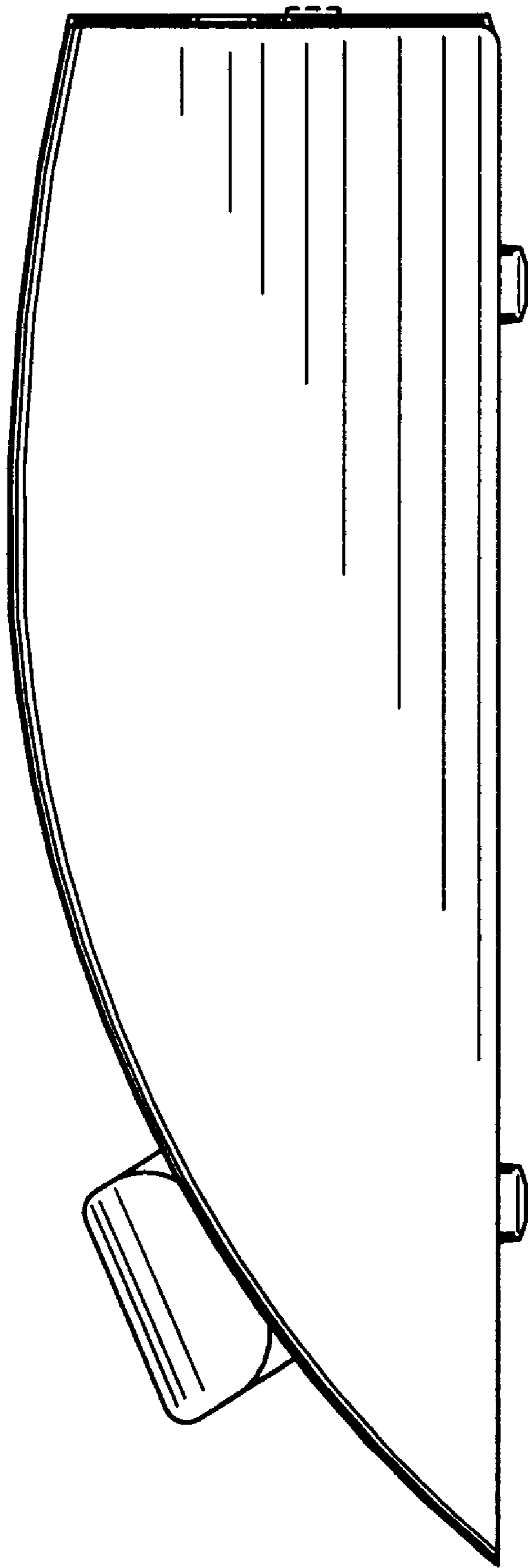

Fig-5

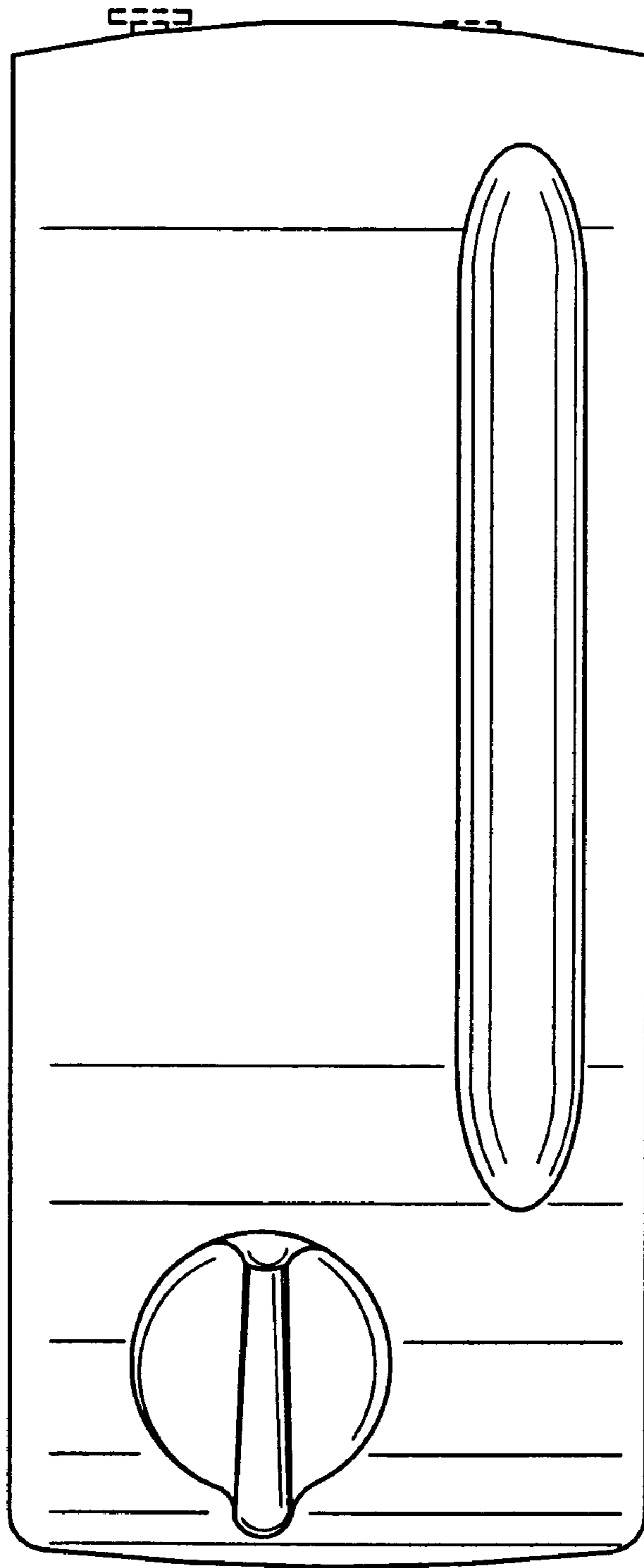

Fig- 6

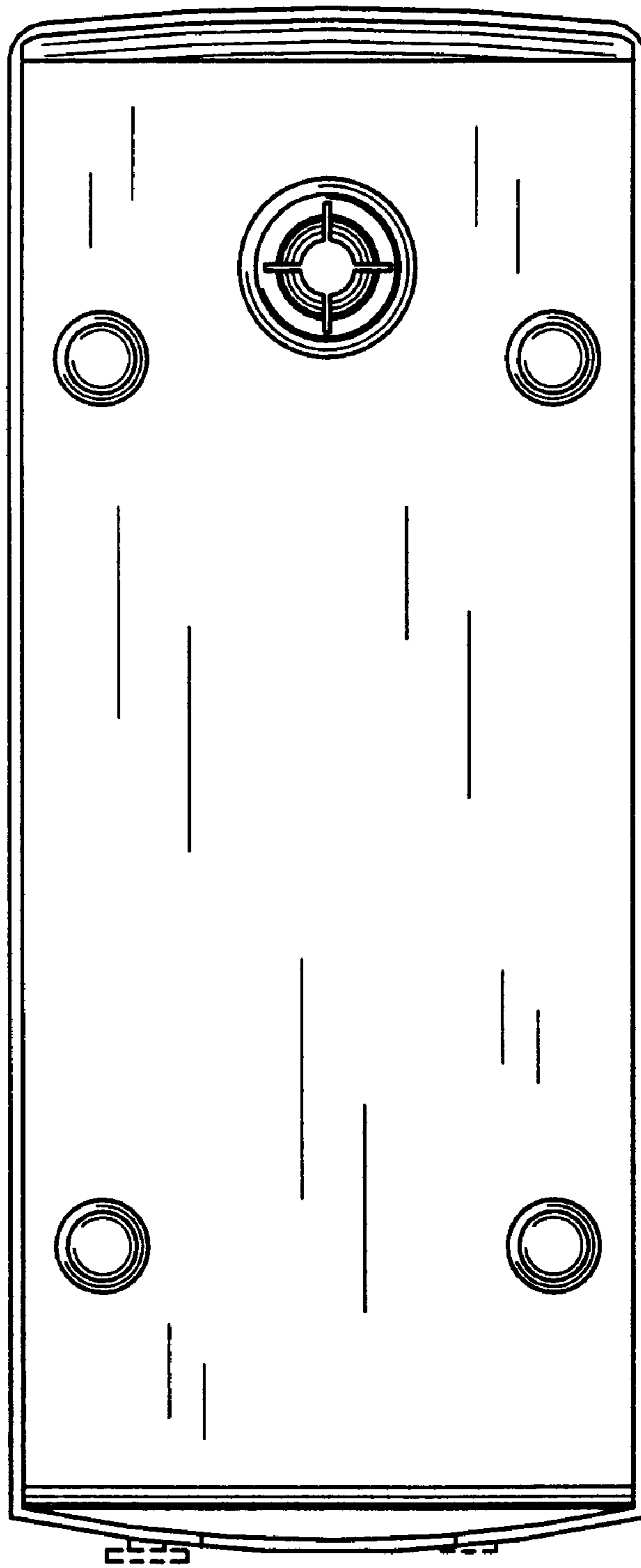

Fig-7