



US00D433112S

United States Patent [19]
Louis, Jr.

[11] **Patent Number: Des. 433,112**

[45] **Date of Patent: ** Oct. 31, 2000**

[54] **PORTABLE MISTING DEVICE**

[76] Inventor: **Ralph Frank Louis, Jr.**, 5475 Round Meadow Rd., Hidden Hills, Calif. 91302

[**] Term: **14 Years**

[21] Appl. No.: **29/109,714**

[22] Filed: **Aug. 19, 1999**

[51] **LOC (7) Cl.** **23-04**

[52] **U.S. Cl.** **D23/360**

[58] **Field of Search** D23/356-363;
239/34, 55-57; 261/81, DIG. 65, DIG. 48;
422/4, 124, 305

[56] **References Cited**

U.S. PATENT DOCUMENTS

3,469,785 9/1969 Boucher et al. 261/DIG. 17
4,229,415 10/1980 Bryson 261/DIG. 17

Primary Examiner—Lisa Lichtenstein

Attorney, Agent, or Firm—Blakely, Sokoloff, Taylor & Zafman, LLP

[57] **CLAIM**

The ornamental design for a portable misting device, as shown and described.

DESCRIPTION

FIG. 1 is a top, front and side perspective view of a portable misting device.

FIG. 2 is a front elevational view thereof;

FIG. 3 is a top plan view thereof;

FIG. 4 is a rear elevational view thereof;

FIG. 5 is a bottom plan view thereof;

FIG. 6 is a left side elevational view thereof;

FIG. 7 is a right side elevational view thereof;

FIG. 8 is a front, top and side perspective view thereof with the handle in folded down position; and,

FIG. 9 is a rear, top and side perspective view thereof on a reduced scale.

The broken line showing of environmental structure in FIGS. 8 and 9 is for illustrative purposes only and forms no part of the claimed design.

1 Claim, 4 Drawing Sheets

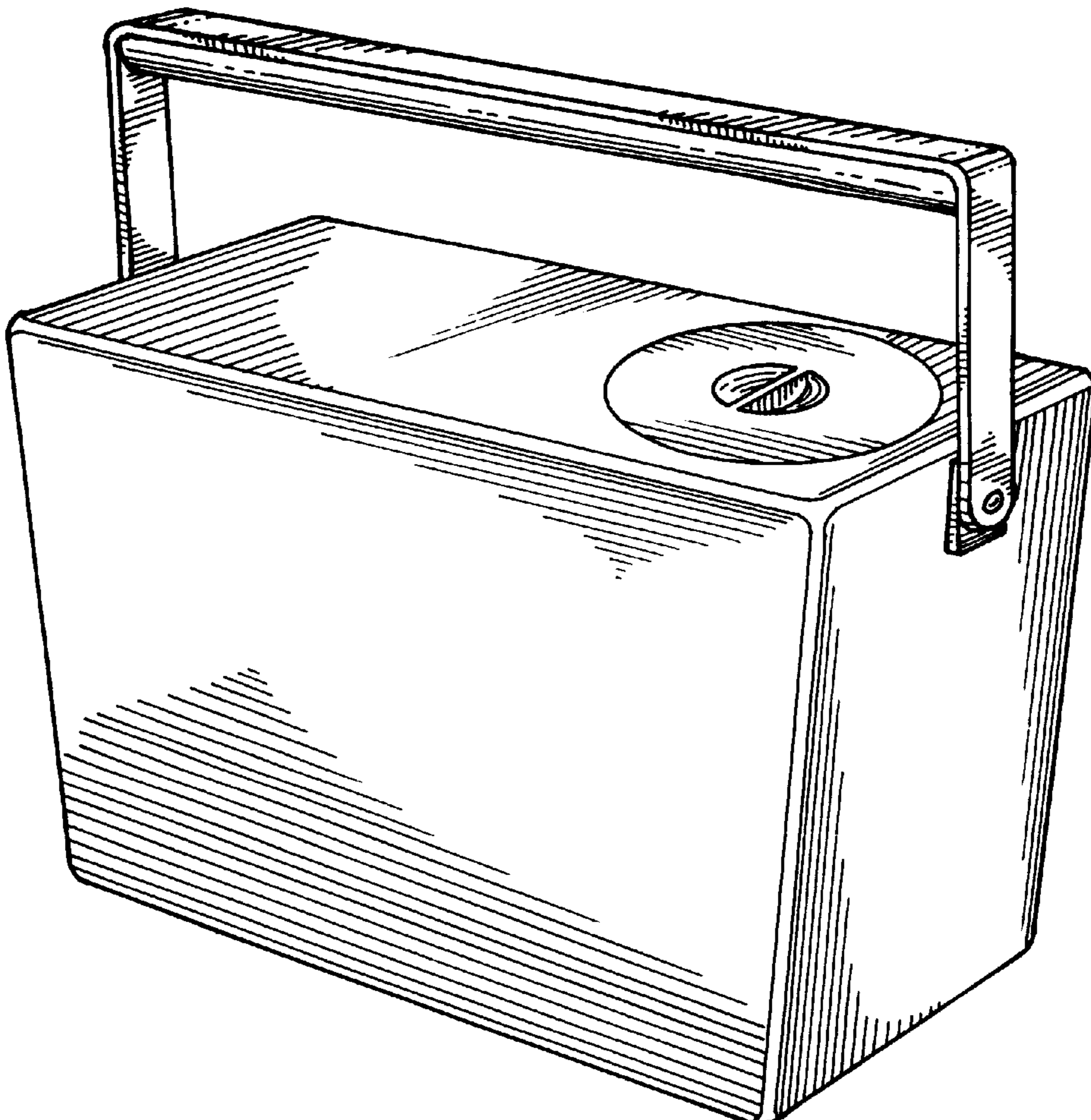

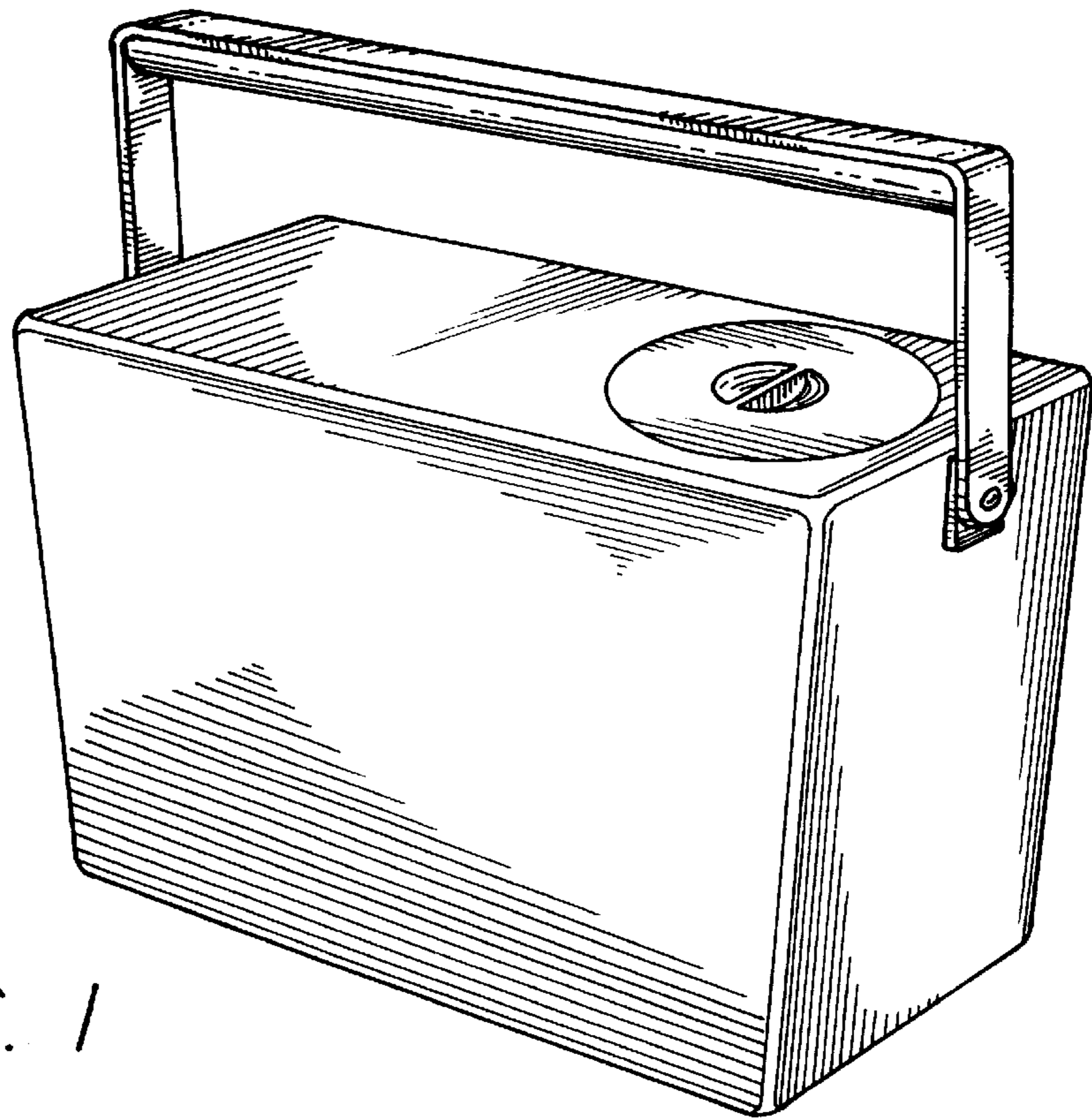

FIG. 1

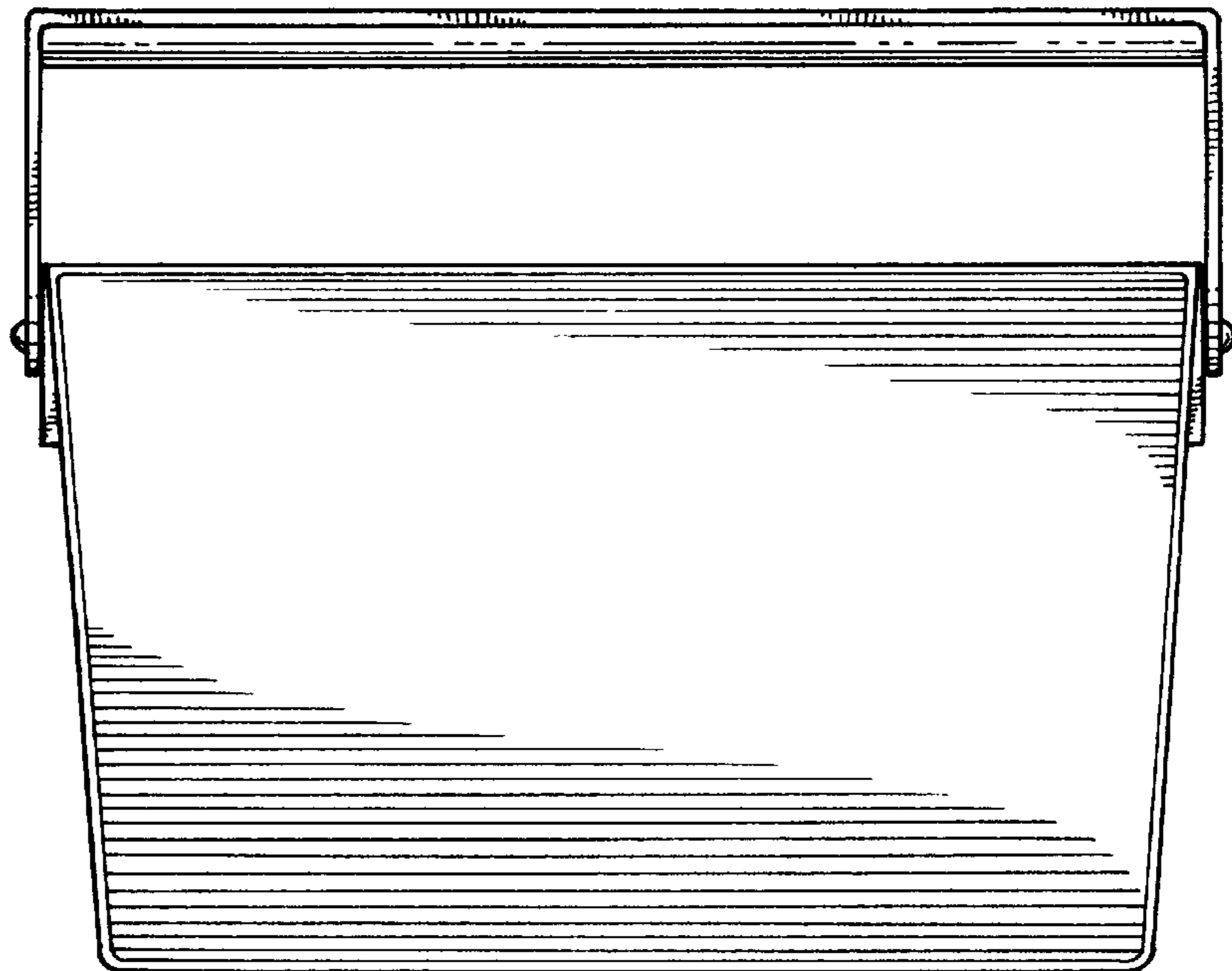

FIG. 2

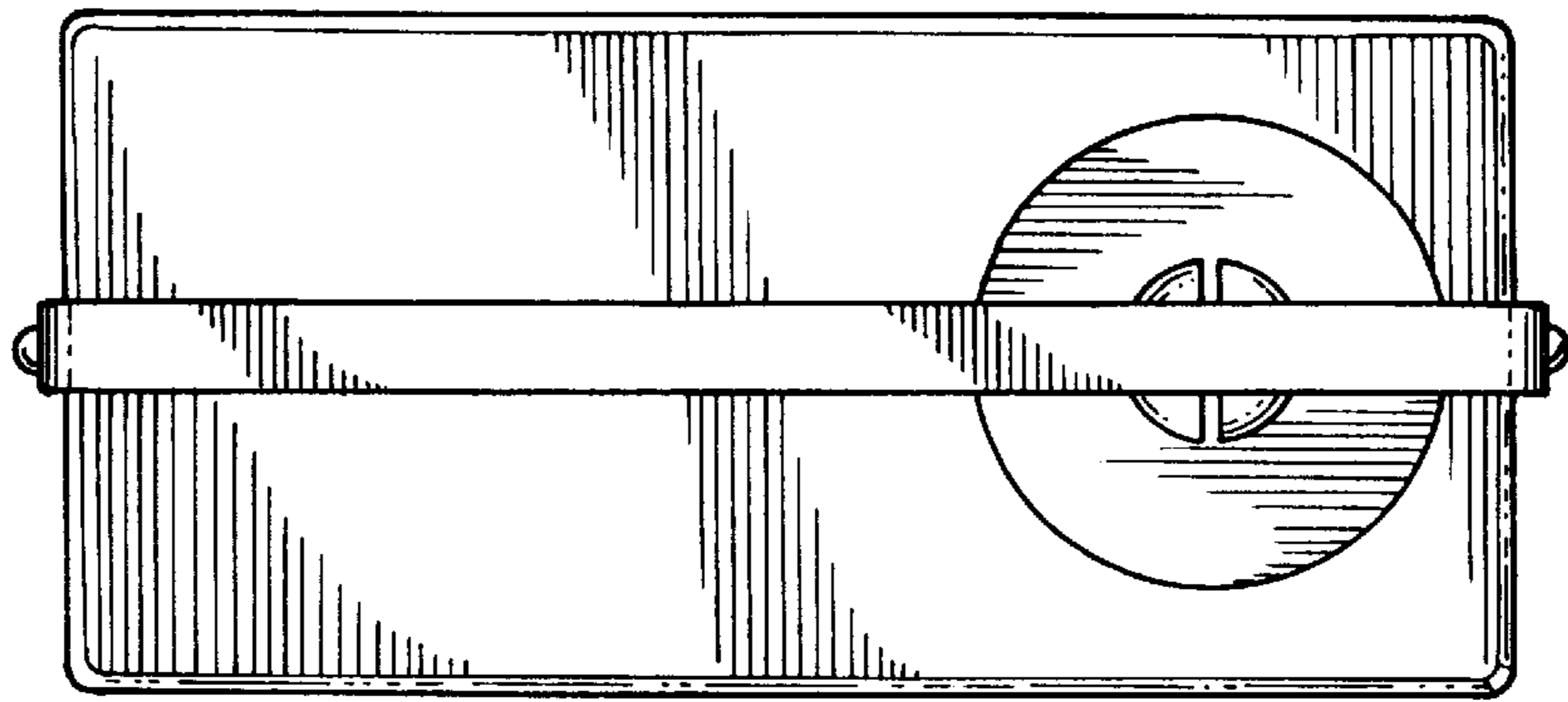

FIG. 3

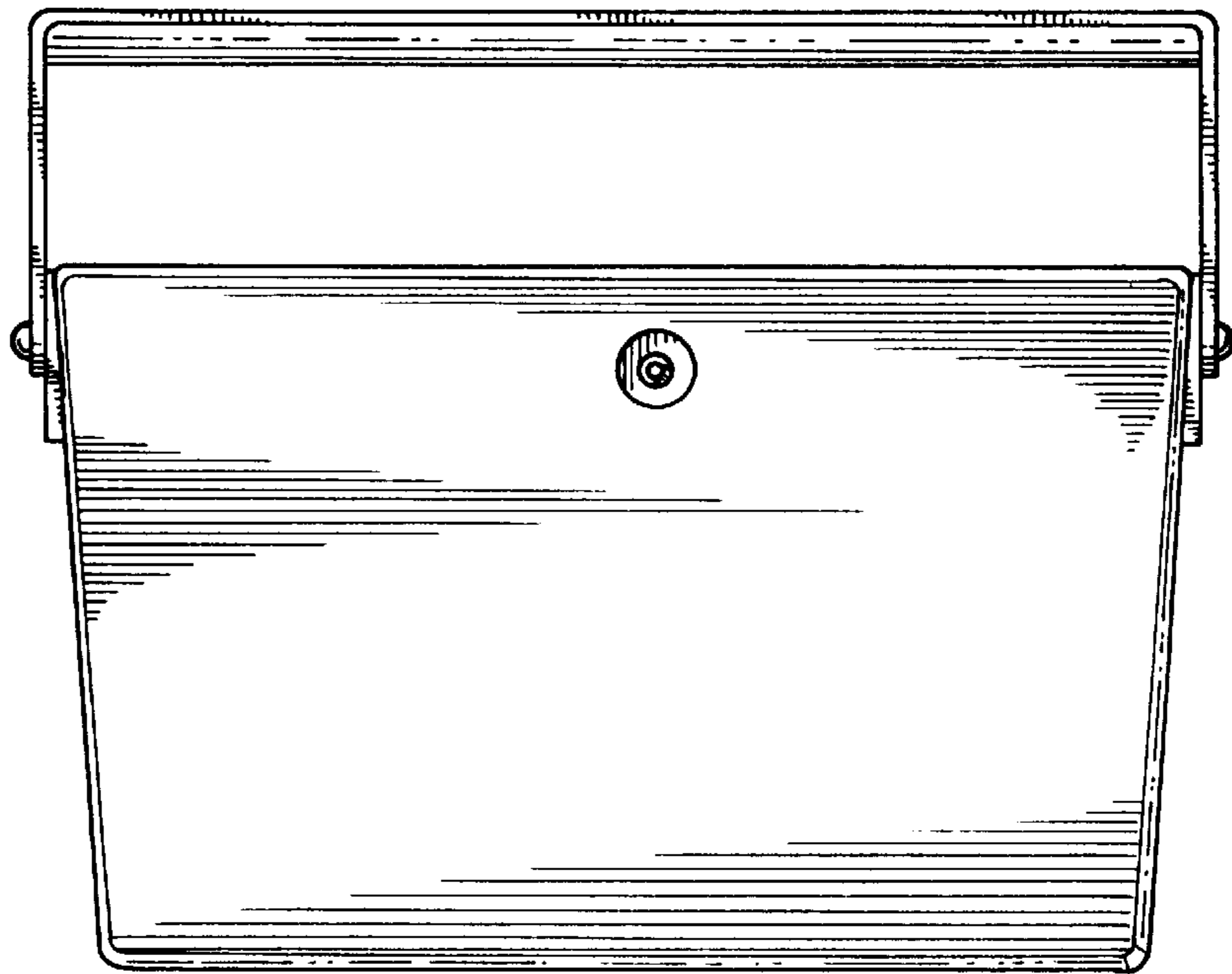

FIG. 4

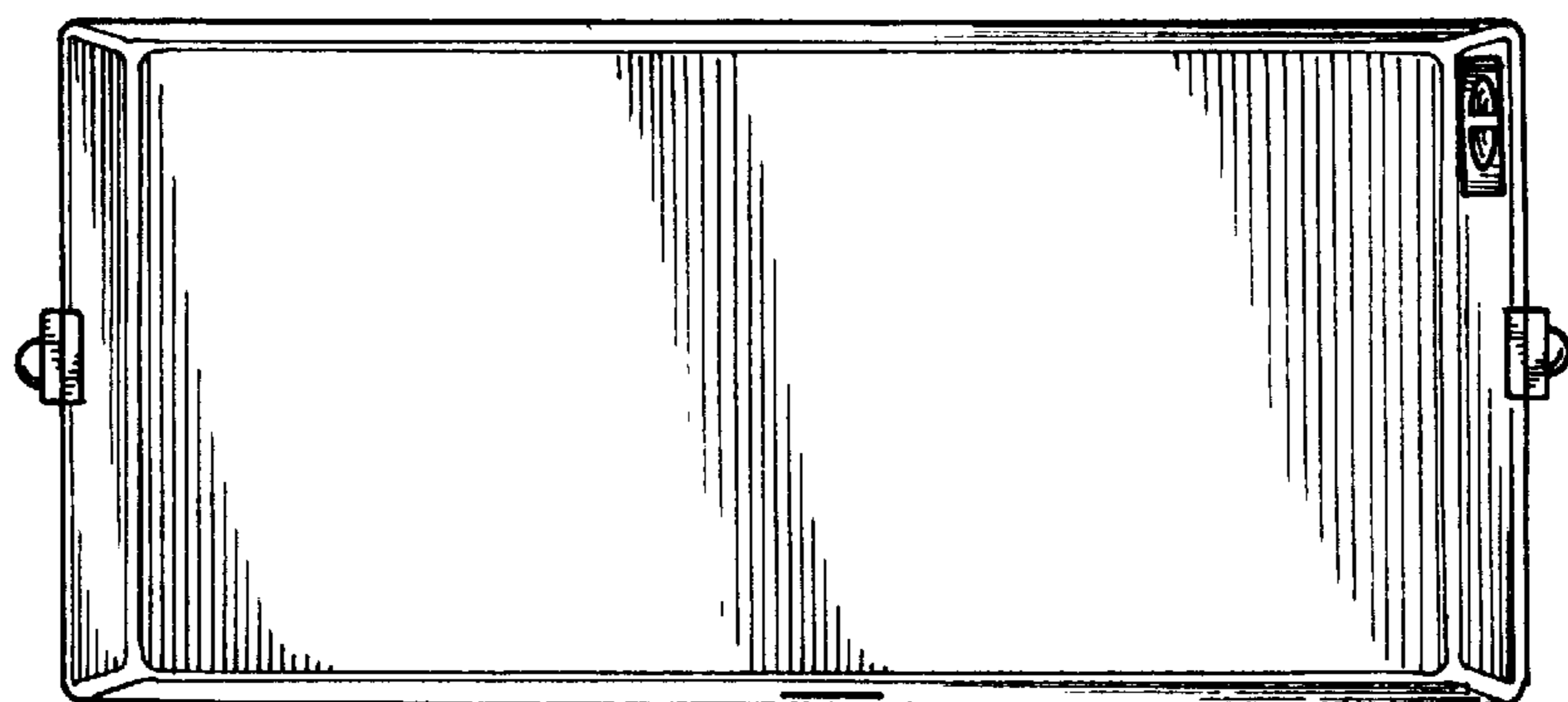

FIG. 5

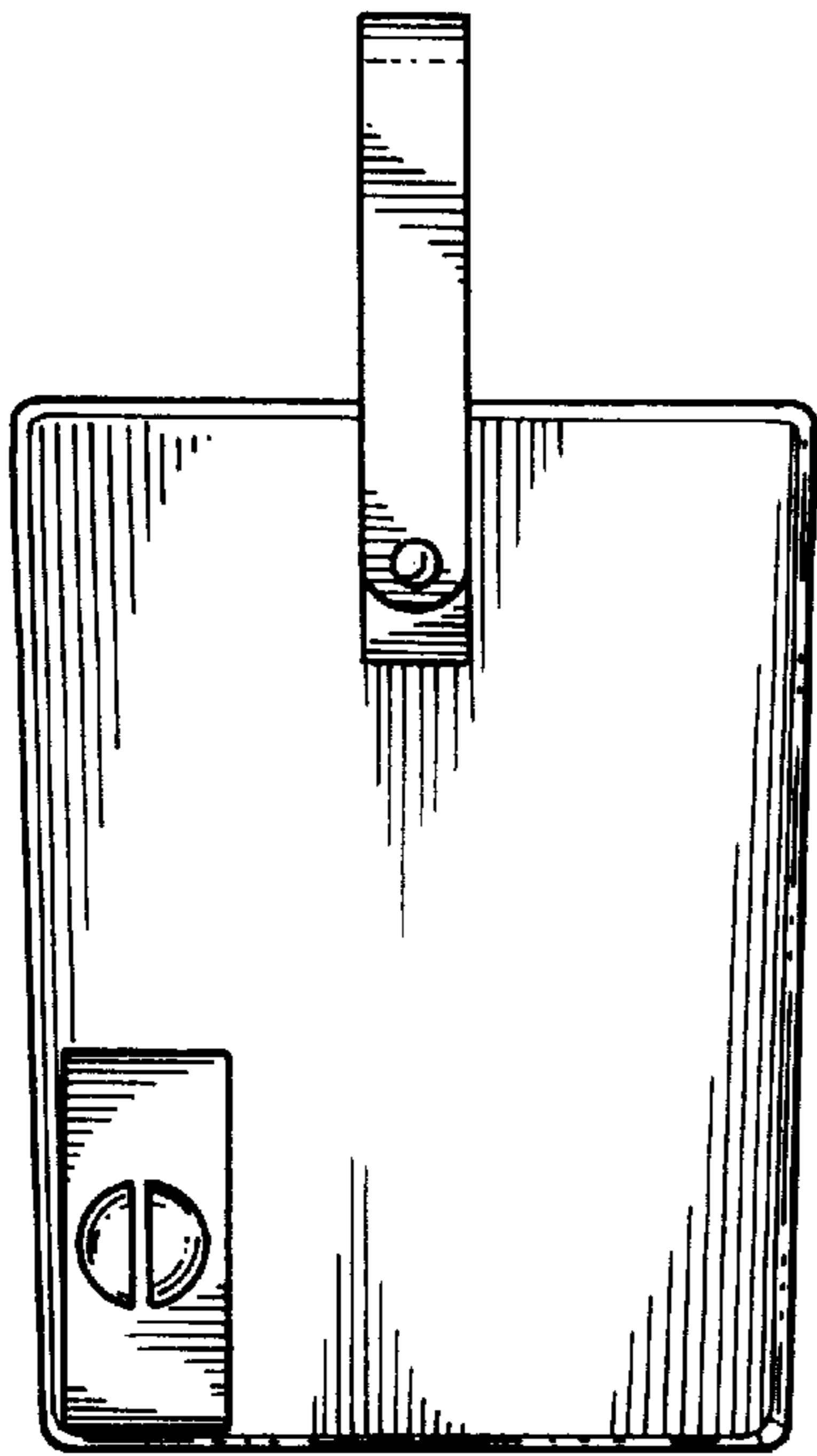

FIG. 6

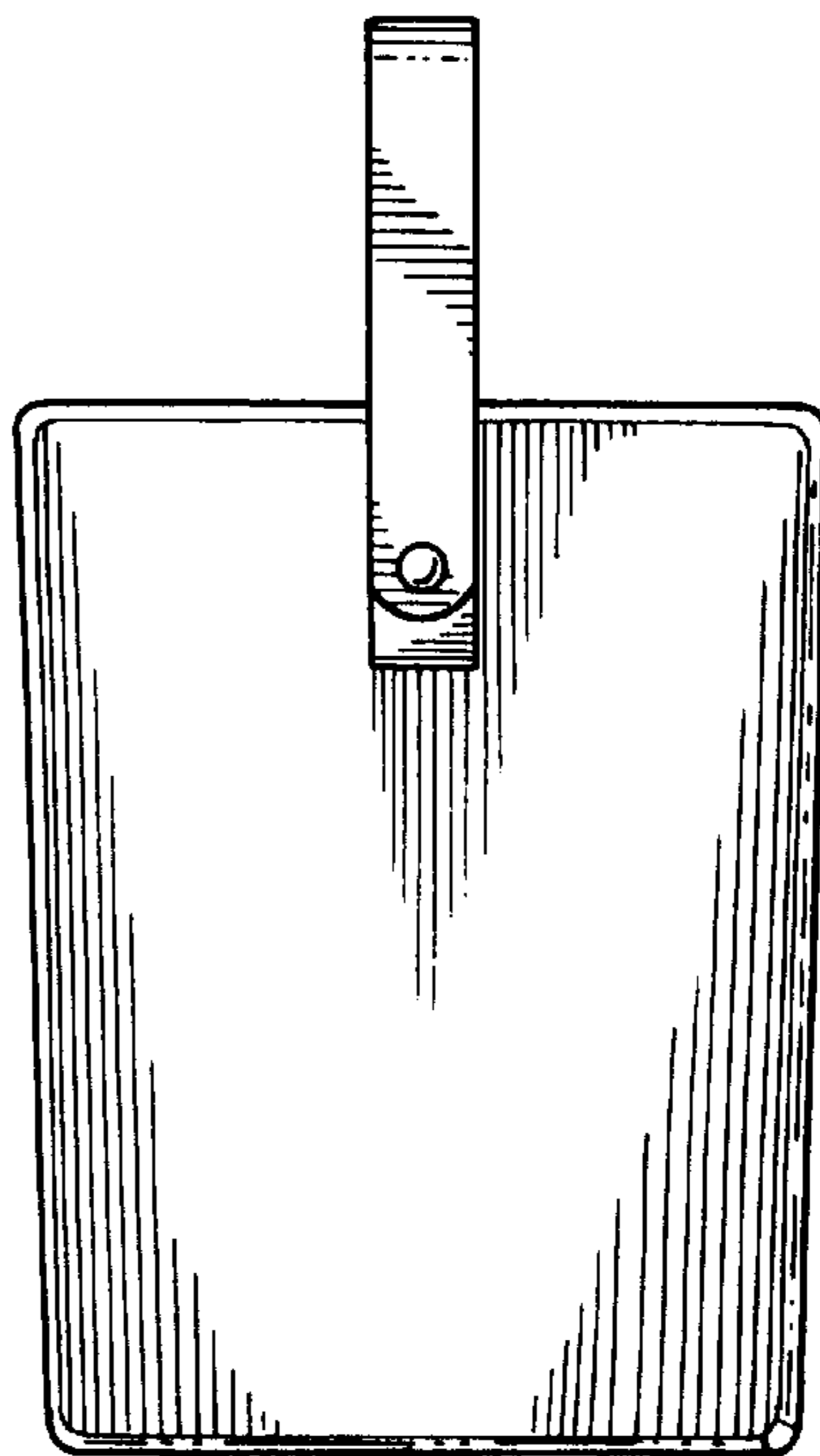

FIG. 7

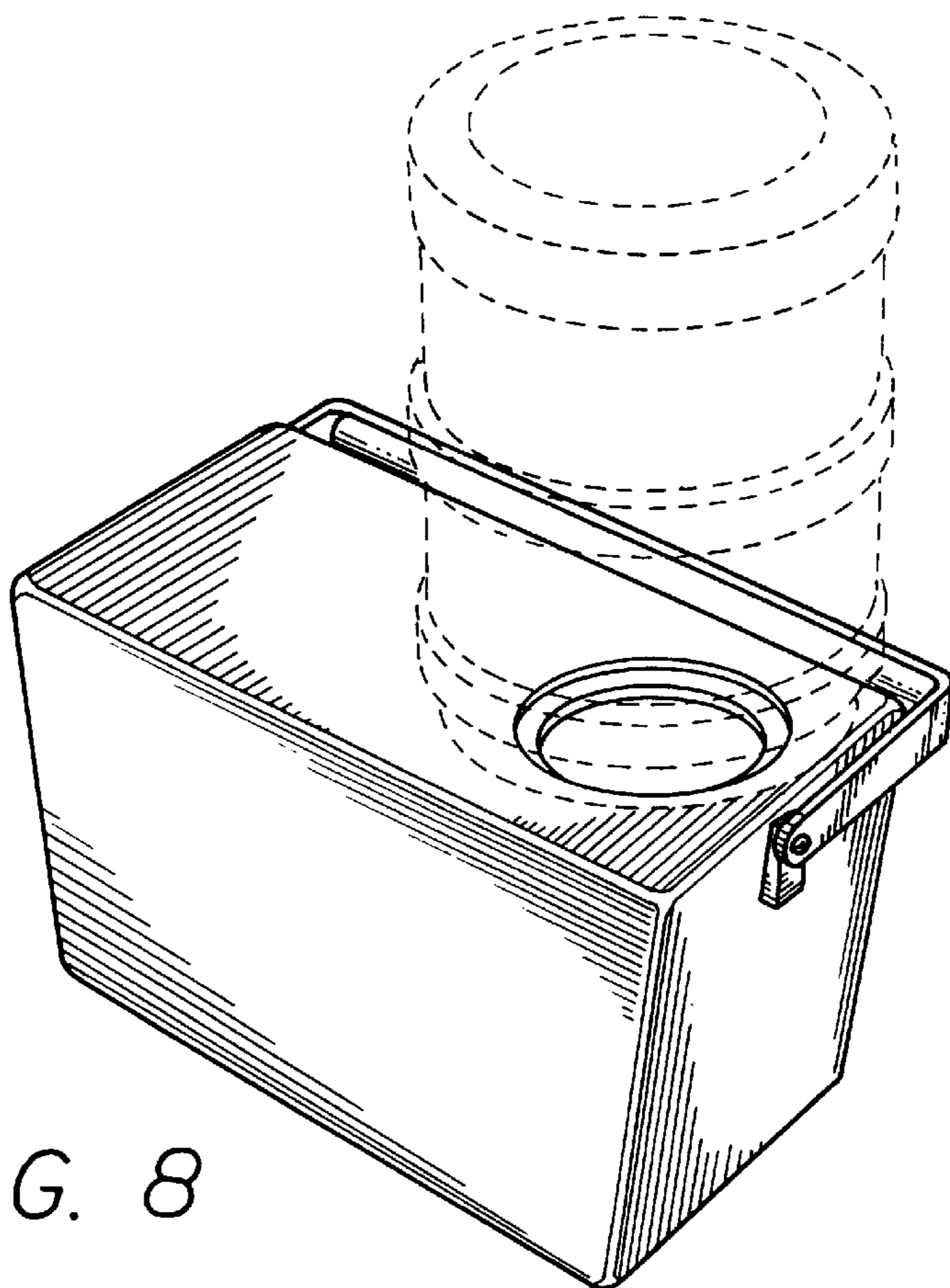

FIG. 8

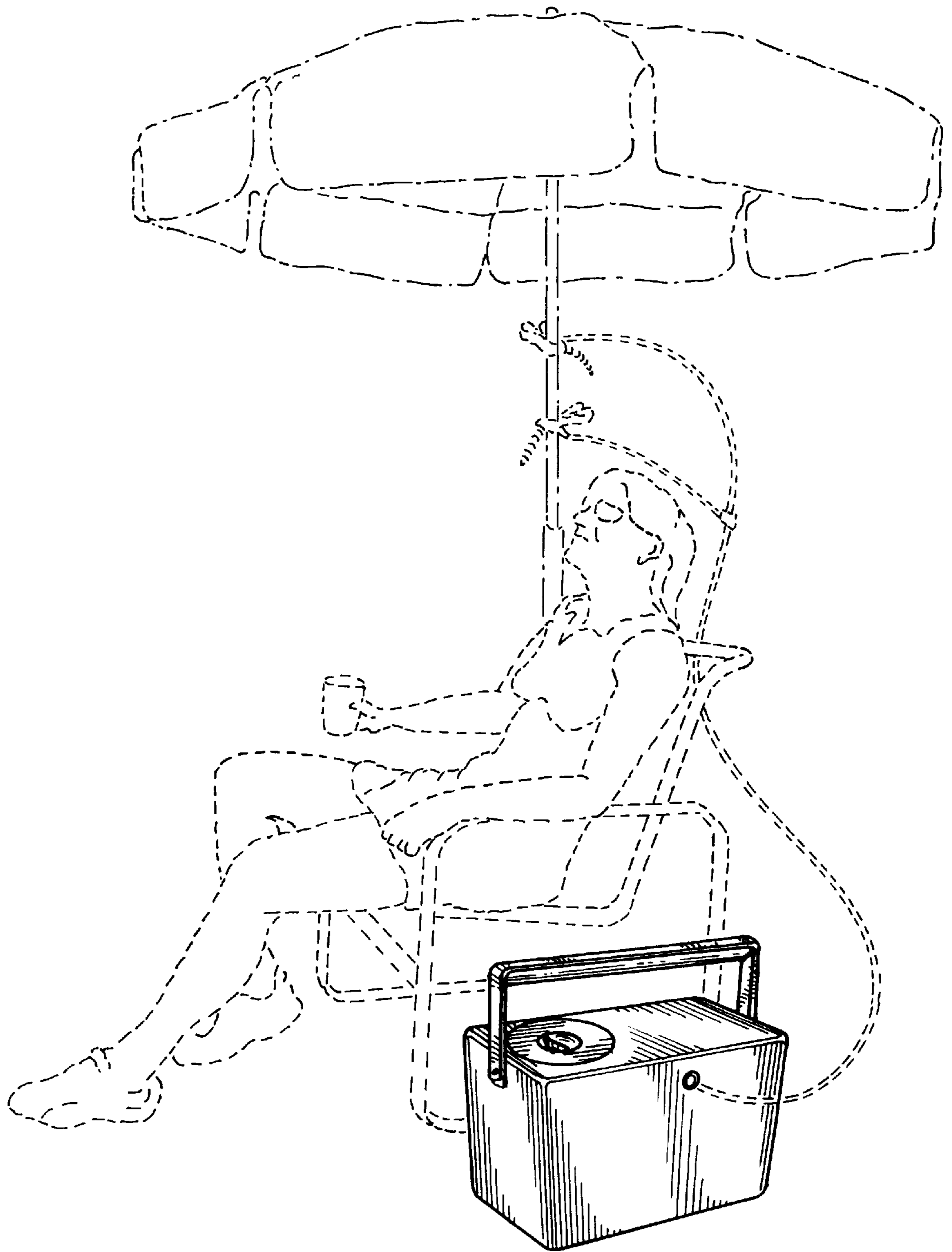

FIG. 9