



US00D432899S

# United States Patent [19]

[11] **Patent Number: Des. 432,899**

**Nistor et al.**

[45] **Date of Patent: \*\* Oct. 31, 2000**

[54] **LANCE LATCH**

*Attorney, Agent, or Firm—Duane Morris & Heckscher LLP*

[75] Inventors: **Elena Nistor**, Toronto; **Wayne Jeffrey Stevens**, Alliston, both of Canada

[57] **CLAIM**

[73] Assignees: **Bayform Div of Bay Mills**, Weston, Canada; **CertainTeed Corp**, Valley Forge, Pa.

The ornamental design for a lance latch, as shown and described.

[\*\*] Term: **14 Years**

**DESCRIPTION**

[21] Appl. No.: **29/111,101**

FIG. 1: is a front perspective view for the lance latch with an anti-fallout feature of this invention;

[22] Filed: **Sep. 20, 1999**

FIG. 2: is a left elevation view of the lance latch of FIG. 1;

[51] **LOC (7) Cl.** ..... **08-07**

[52] **U.S. Cl.** ..... **D8/331; D8/400**

[58] **Field of Search** ..... D8/400, 330, 331, D8/343; 292/202, 203, 228, 229, 194, 242, 241

FIG. 3: is a right elevation view of the lance latch of FIG. 1;

FIG. 4: is a rear plan view of the lance latch of FIG. 1;

FIG. 5: is a front plan view of the lance latch of FIG. 1;

FIG. 6: is a top plan view of the lance latch of FIG. 1;

FIG. 7: is a bottom plan view of the lance latch of FIG. 1; and,

FIG. 8: is a three-quarter top plan view of the lance latch of FIG.1, as viewed from the position and angle identified with line 8—8 in FIG. 2.

[56] **References Cited**

**U.S. PATENT DOCUMENTS**

|            |         |                |       |           |
|------------|---------|----------------|-------|-----------|
| D. 402,181 | 12/1998 | Hayes          | ..... | D8/343    |
| 2,955,860  | 10/1960 | Jacques        | ..... | 292/194 X |
| 3,891,256  | 6/1975  | Johnson et al. | ..... | 292/202   |

**OTHER PUBLICATIONS**

Eberhard Manufacturing Mfg., No. 2-2500-1 R&L, Dec. 1986, p. 81.

*Primary Examiner—Susan J. Lucas*  
*Assistant Examiner—Jennifer Rivard*

**1 Claim, 2 Drawing Sheets**

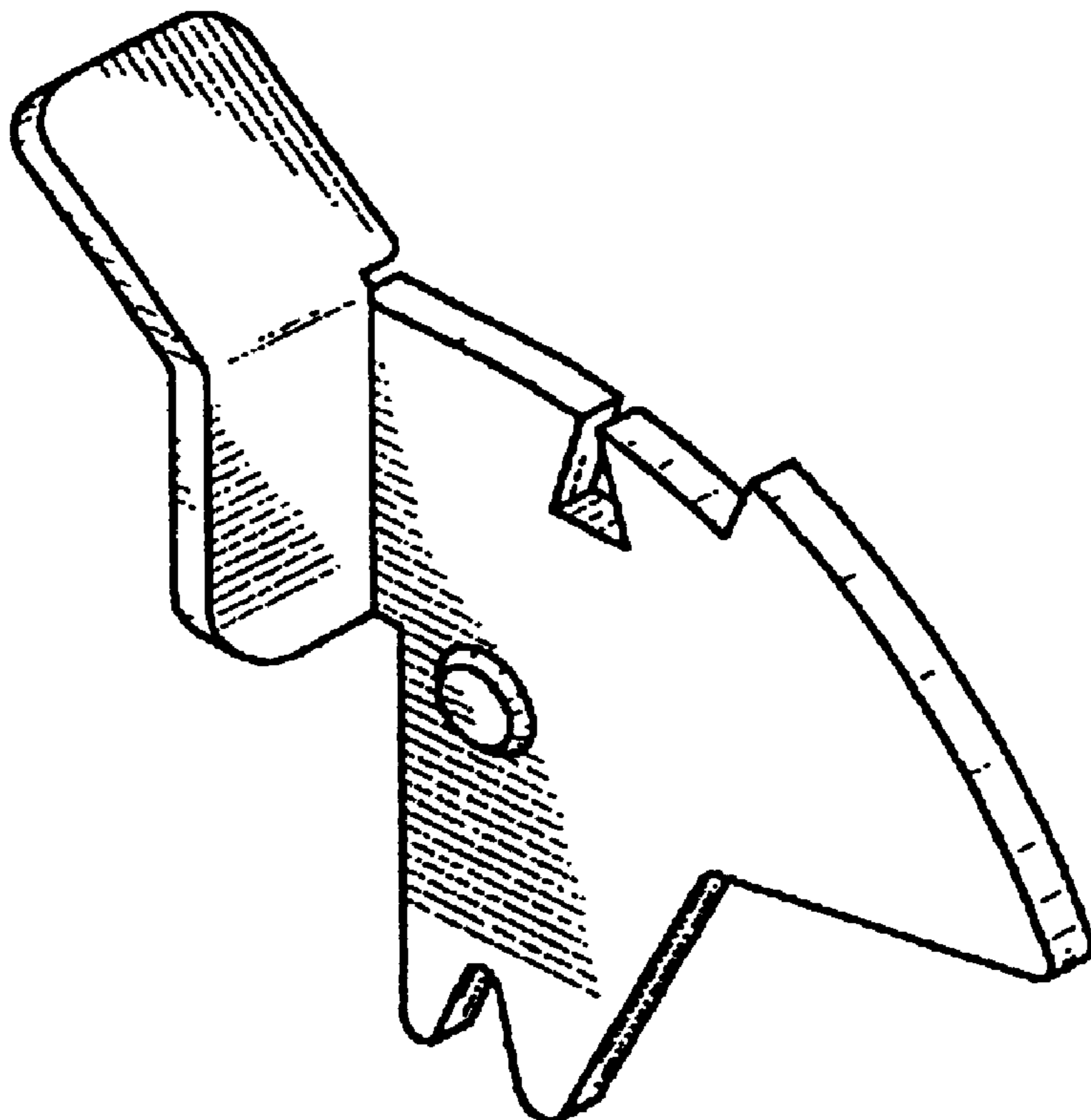

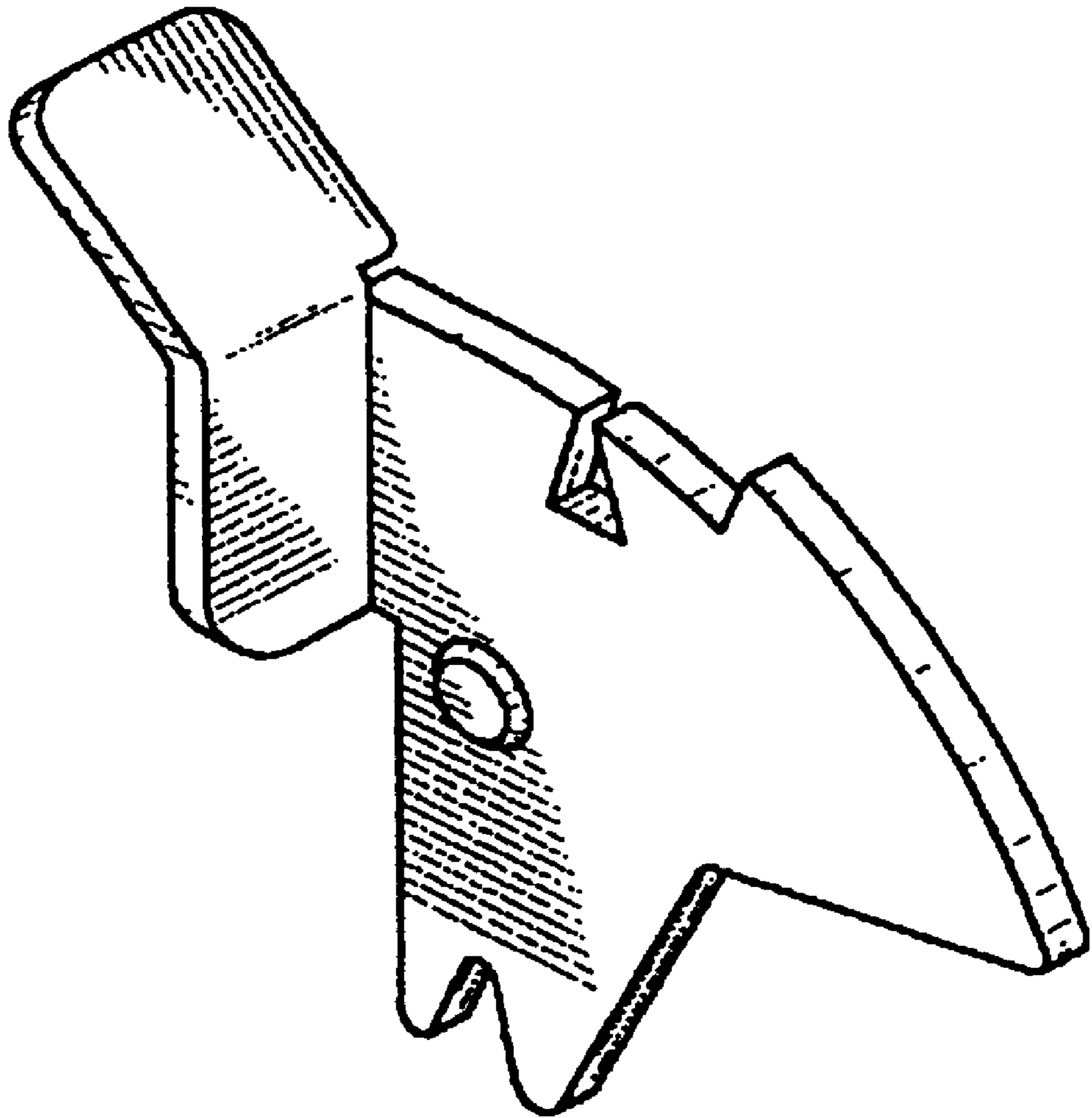

FIG. 1

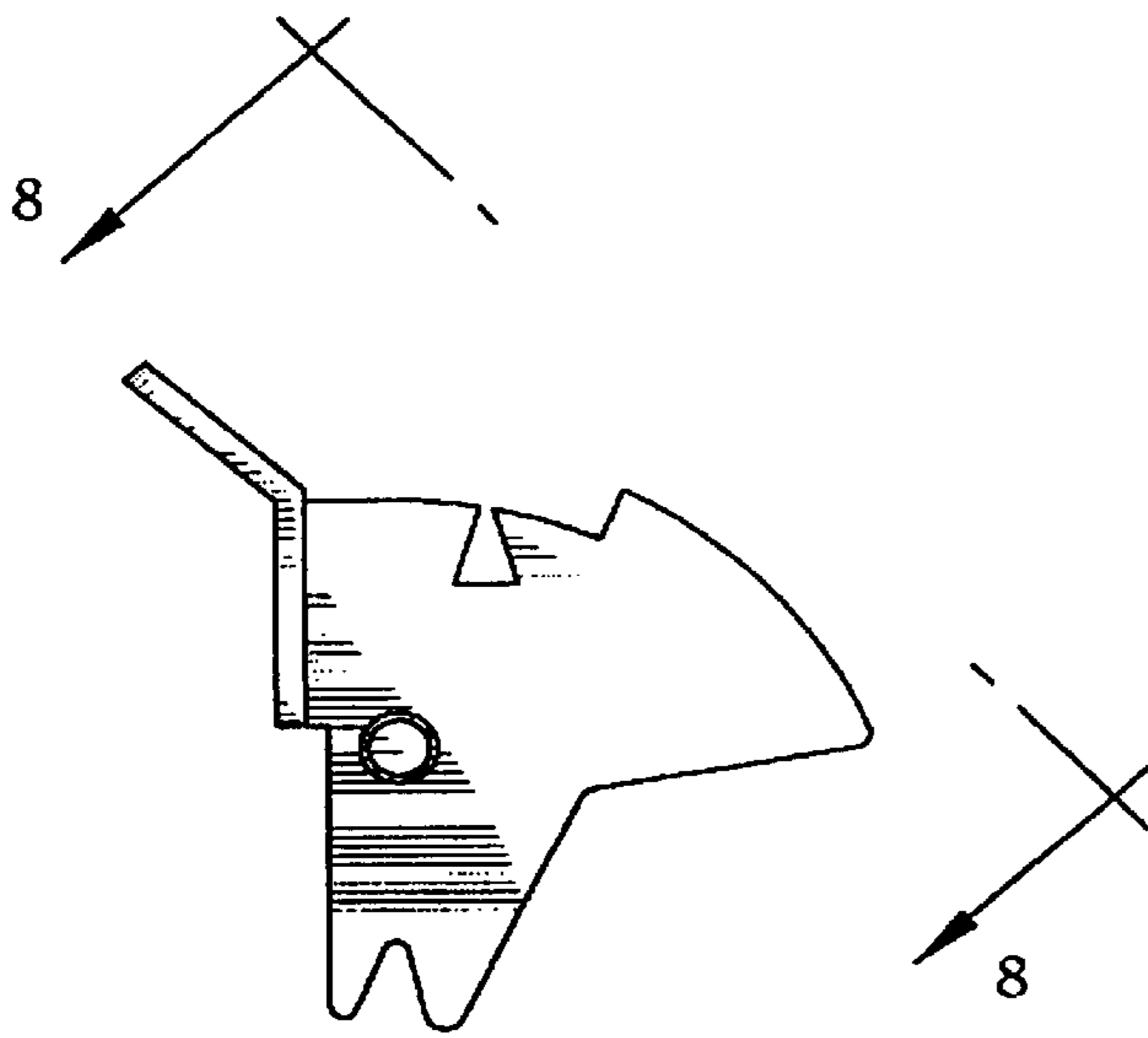

FIG. 2

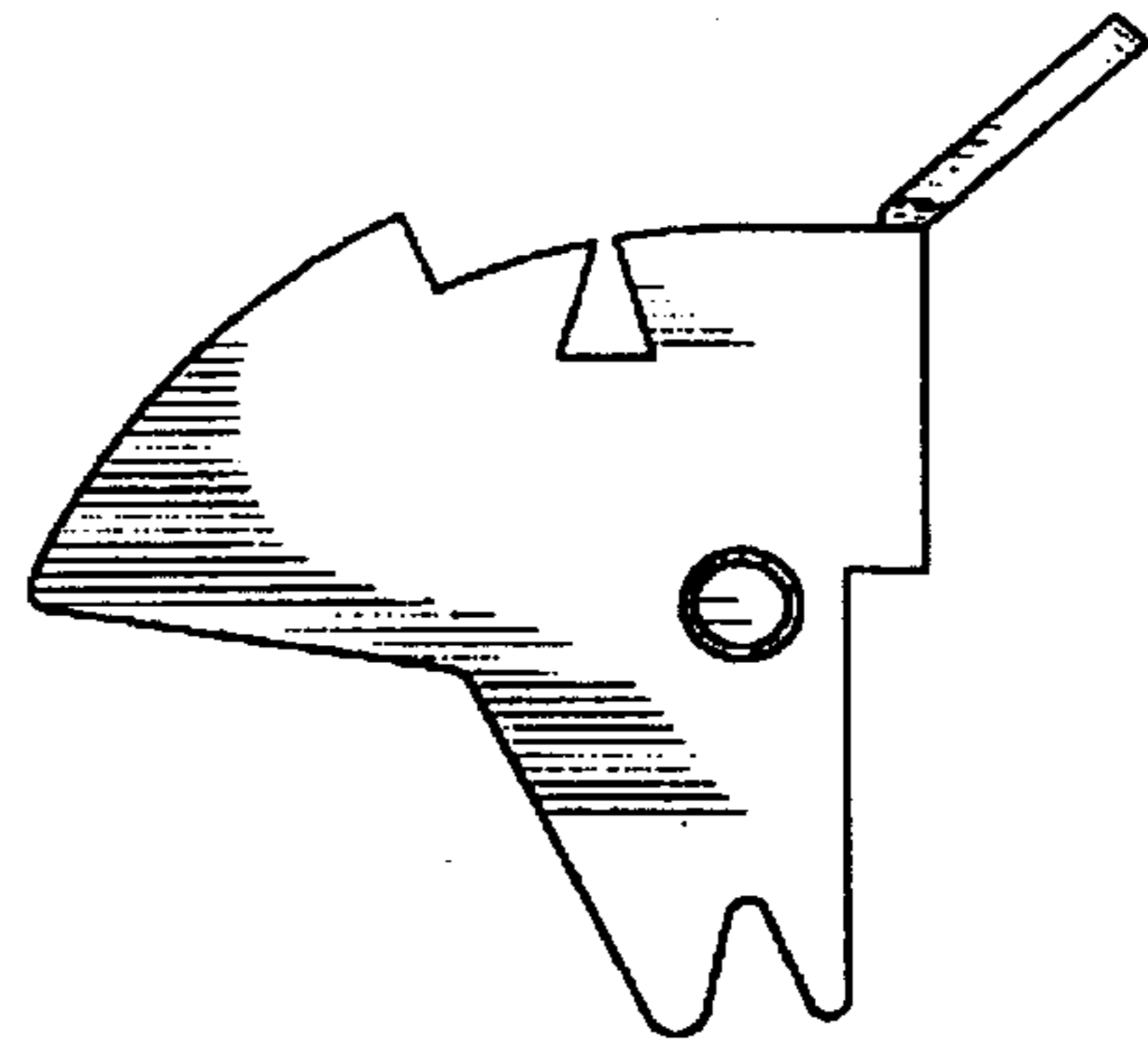

FIG. 3

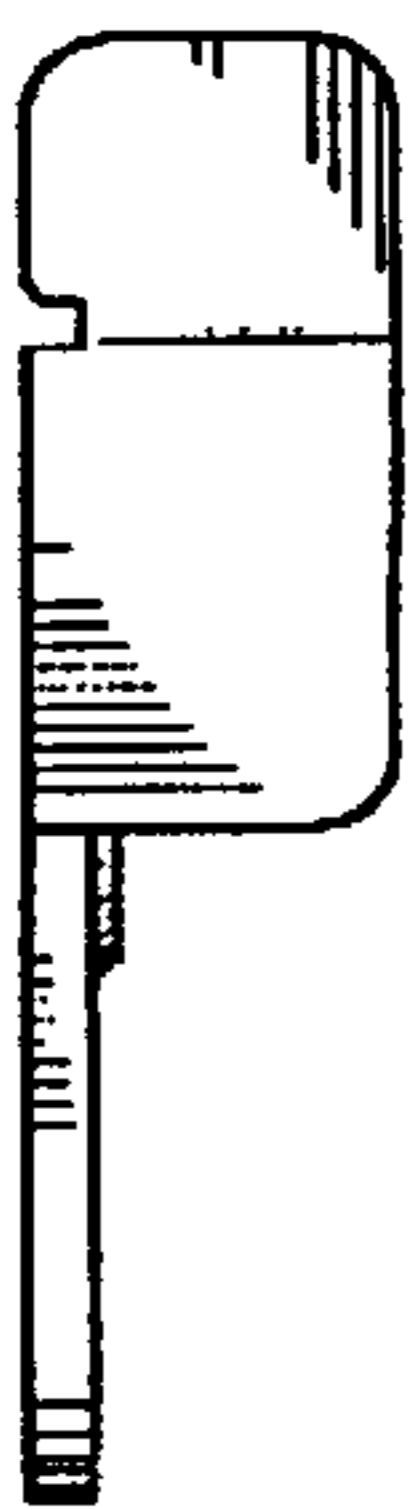

FIG. 4

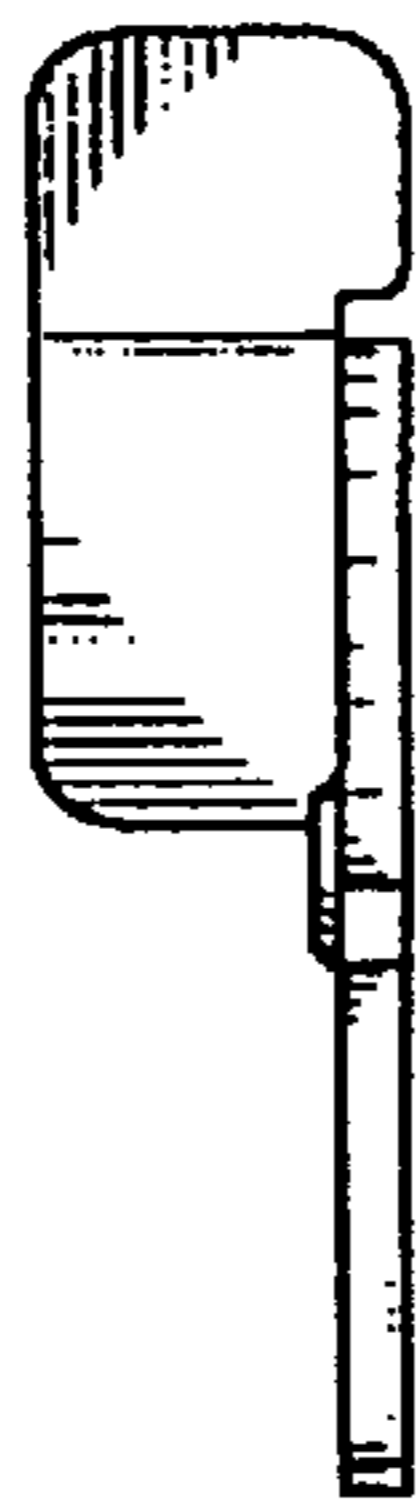

FIG. 5

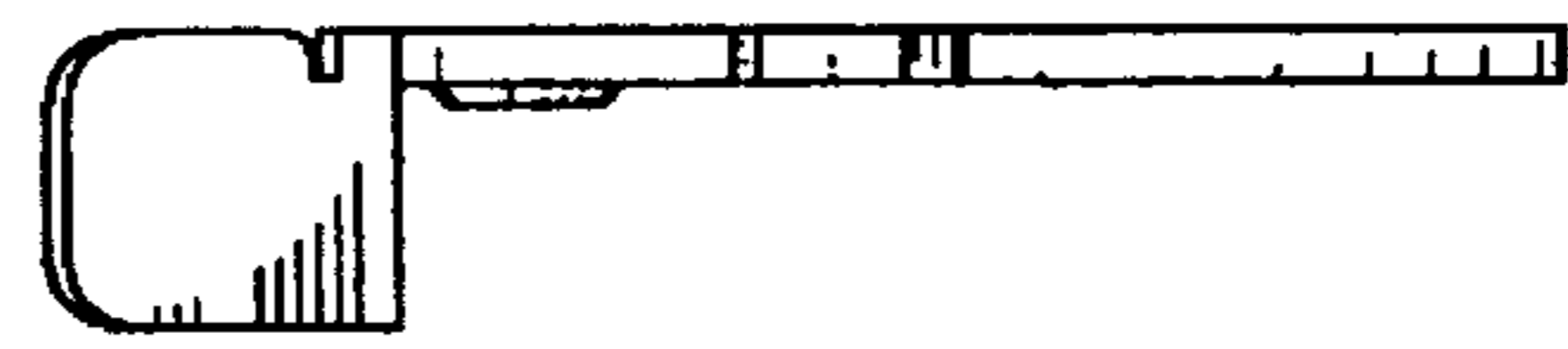

FIG. 6



FIG. 7

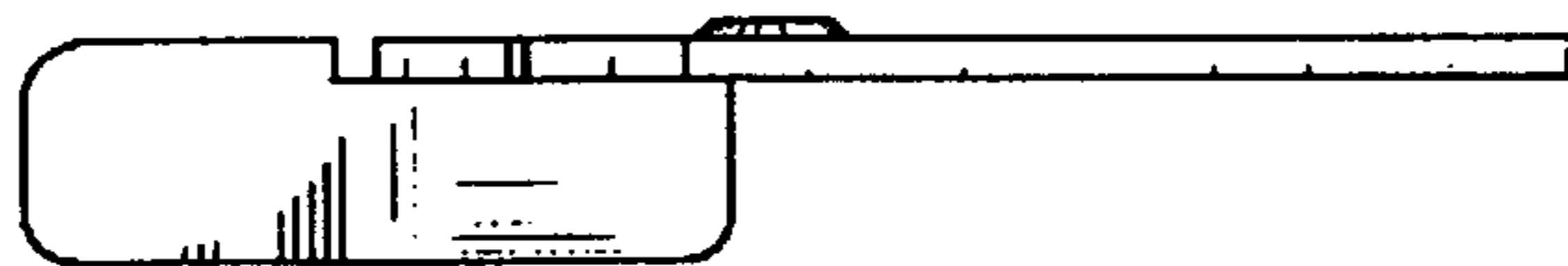

FIG. 8