



US00D432871S

**United States Patent** [19]  
**Nottingham et al.**

[11] **Patent Number: Des. 432,871**  
[45] **Date of Patent: \*\* Oct. 31, 2000**

[54] **THERMAL FOOD BAG**

[75] Inventors: **John Nottingham**, Hunting Valley;  
**John Spirk**, Gates Mills; **Jeffrey Plantz**, Medina, all of Ohio

[73] Assignee: **Innovon, L.L.C.**, Cleveland, Ohio

[\*\*] Term: **14 Years**

[21] Appl. No.: **29/112,272**

[22] Filed: **Oct. 14, 1999**

[51] **LOC (7) Cl.** ..... **07-07**

[52] **U.S. Cl.** ..... **D7/607; D3/276**

[58] **Field of Search** ..... D7/605, 607; D3/273,  
D3/276, 290, 292; 62/457.1, 457.7, 371,  
372; 383/97, 109, 110, 113; 220/592.03,  
592.2, 592.25, 915.1, 915.2

[56] **References Cited**

**U.S. PATENT DOCUMENTS**

- D. 260,327 8/1981 Rabinowitz et al. .
- D. 277,904 3/1985 Rabinowitz .
- D. 281,120 10/1985 Rabinowitz .
- D. 299,406 1/1989 Jacober ..... D7/607 X
- D. 374,348 10/1996 Sarver .
- D. 380,945 7/1997 Algeria et al. .
- D. 383,360 9/1997 Melk .
- D. 396,749 8/1998 Ortiz .
- D. 411,419 6/1999 Wyant .
- 3,428,103 2/1969 Walsh .
- 4,805,776 2/1989 Namgyal et al. .... 383/110 X
- 4,816,646 3/1989 Solomon et al. .

**OTHER PUBLICATIONS**

Paper grocery bag.

*Primary Examiner*—Terry A. Wallace  
*Attorney, Agent, or Firm*—Vickers, Daniels & Young

[57] **CLAIM**

The ornamental design for a thermal food bag, as shown and described.

**DESCRIPTION**

FIG. 1 is a front perspective view of a thermal food bag showing our new design, in the unfolded condition with the resealable flap in the closed position;  
 FIG. 2 is a front perspective view thereof, with the resealable flap in the opened position;  
 FIG. 3 is a front perspective view thereof, in the folded condition;  
 FIG. 4 is a top plan view of the thermal food bag shown in FIG. 1;  
 FIG. 5 is a left side elevational view of the thermal food bag shown in FIG. 1;  
 FIG. 6 is a front elevational view of the thermal food bag shown in FIG. 1;  
 FIG. 7 is a right side elevational view of the thermal food bag shown in FIG. 1;  
 FIG. 8 is a back elevational view of the thermal food bag shown in FIG. 1; and,  
 FIG. 9 is a bottom plan view of the thermal food bag shown in FIG. 1.

**1 Claim, 2 Drawing Sheets**

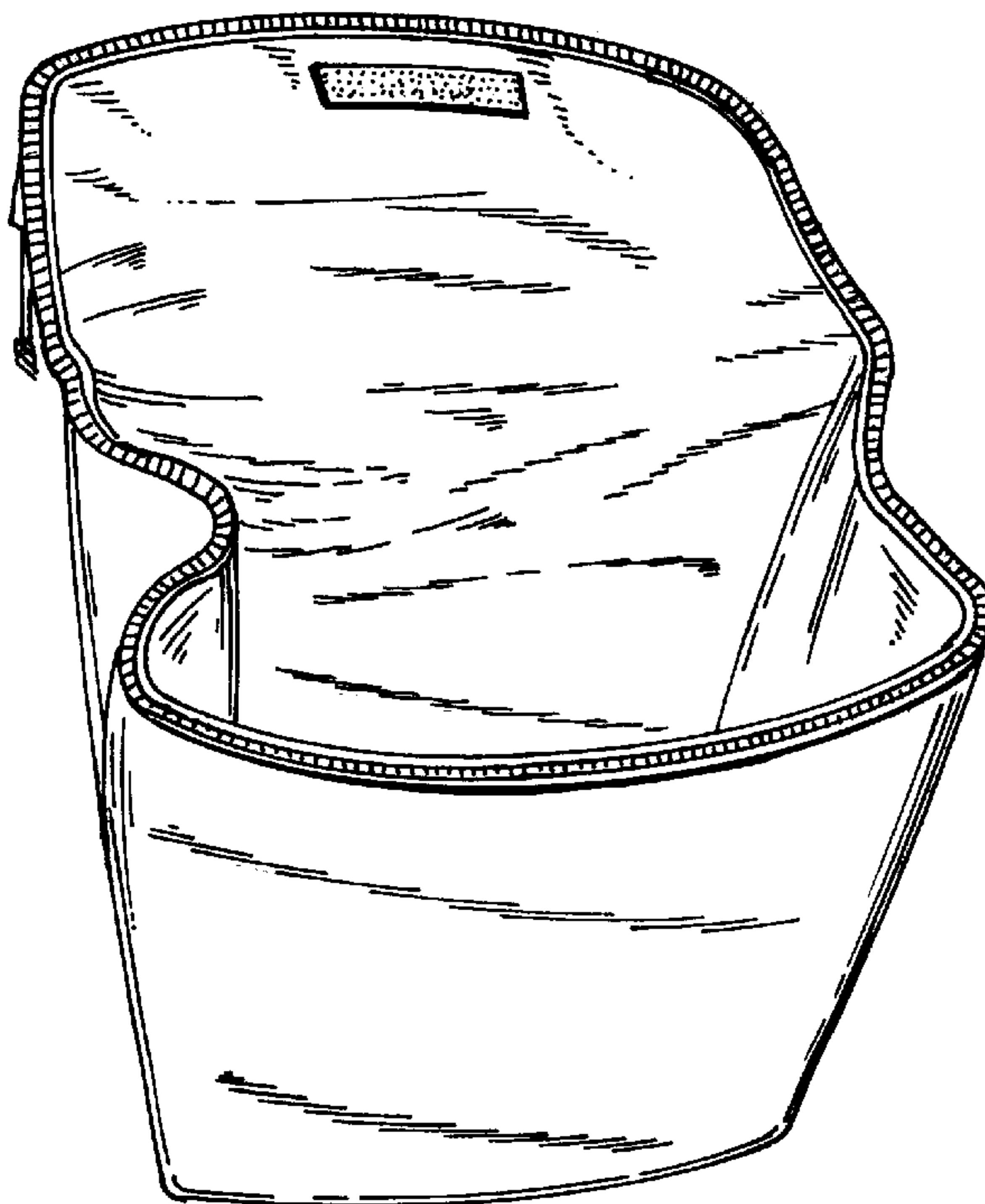
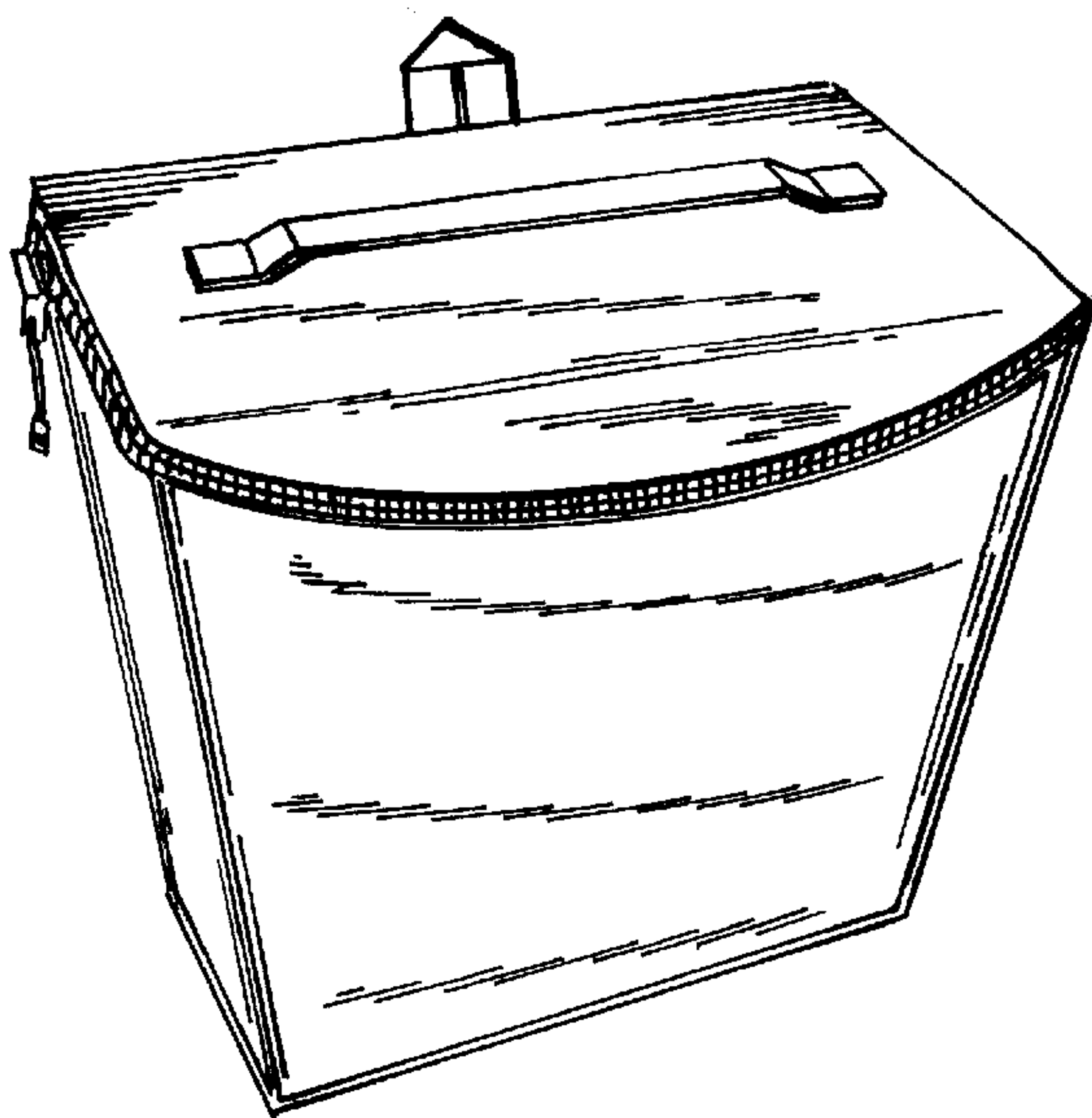

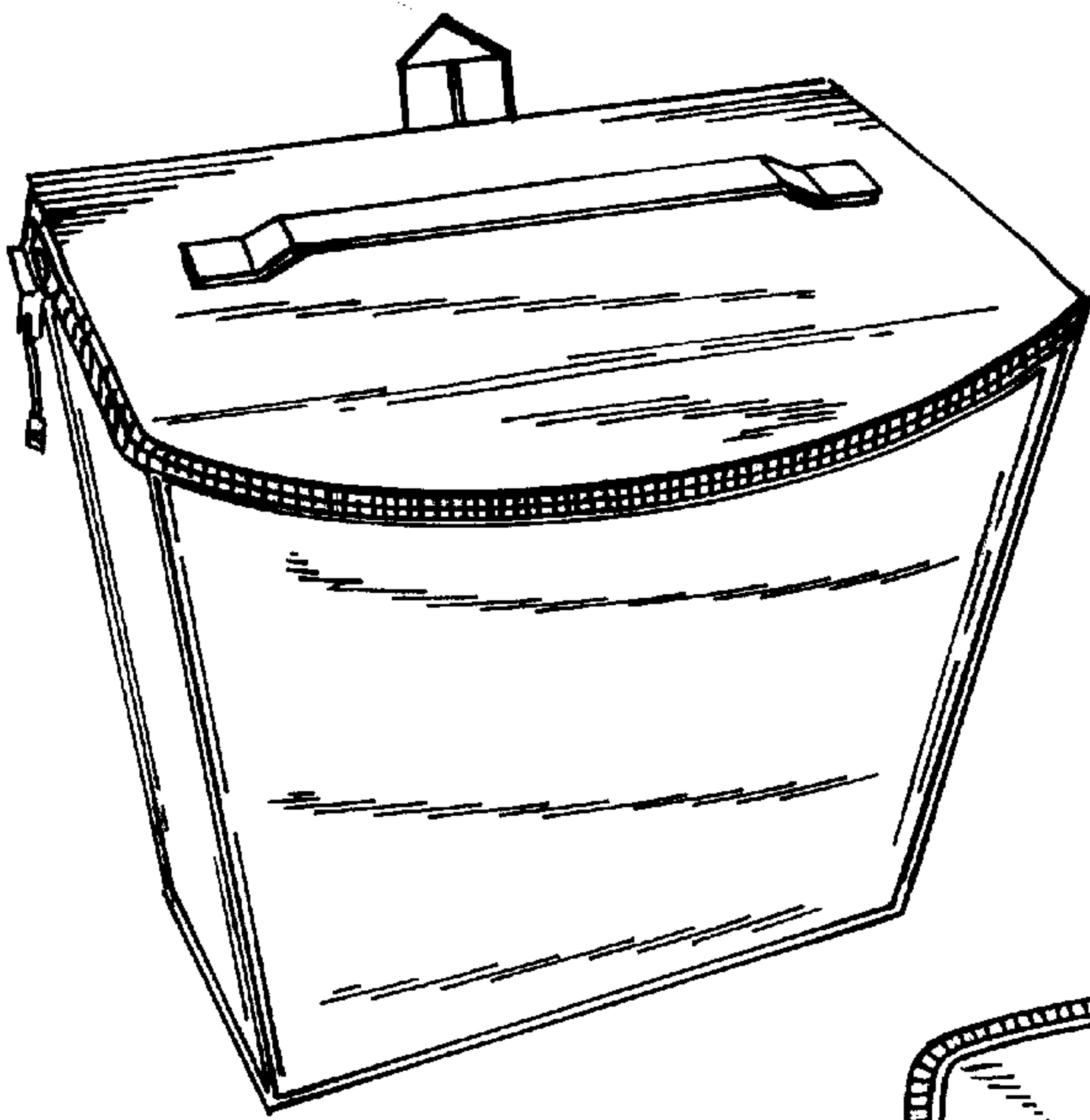

FIG. 1

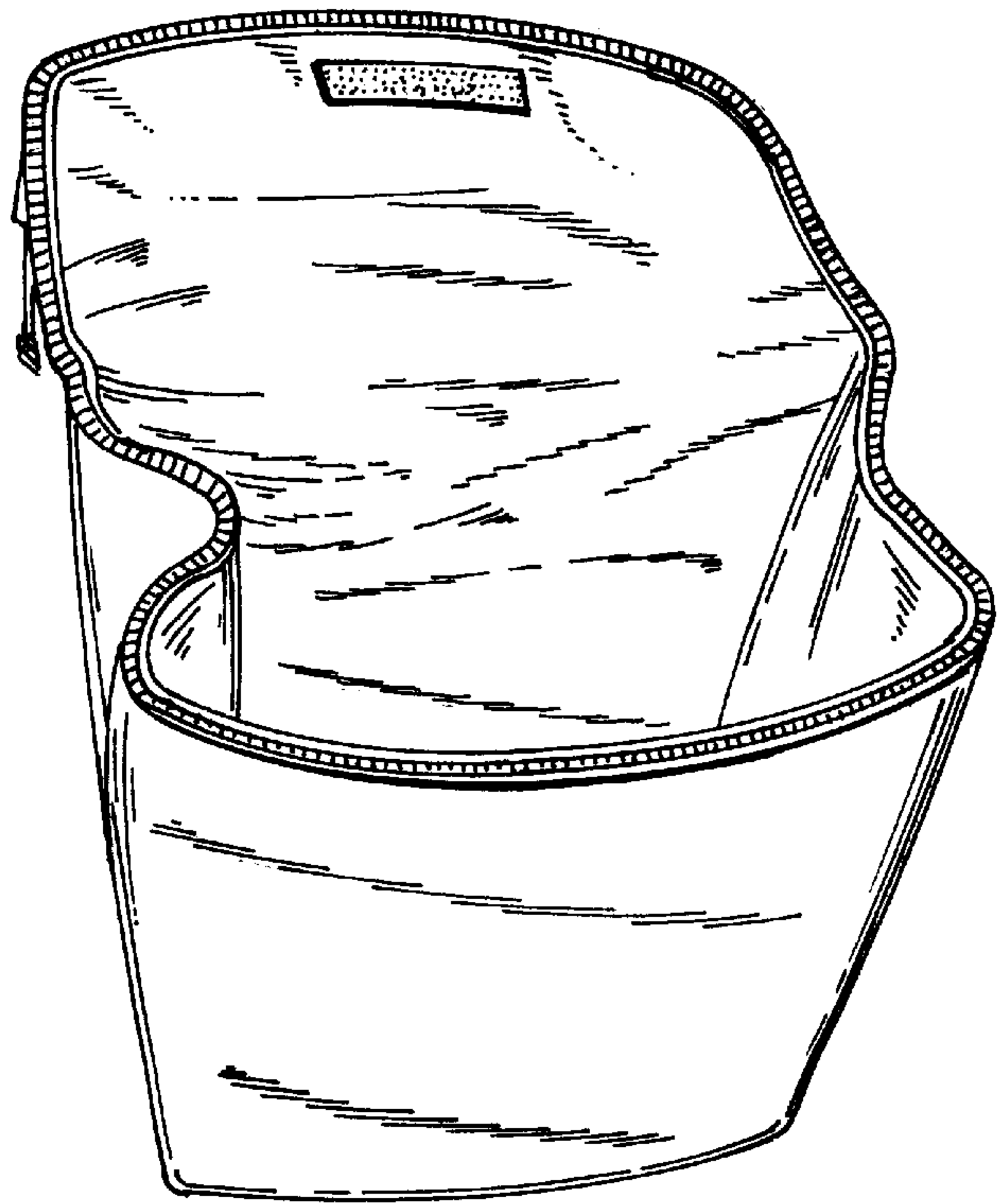

FIG. 2

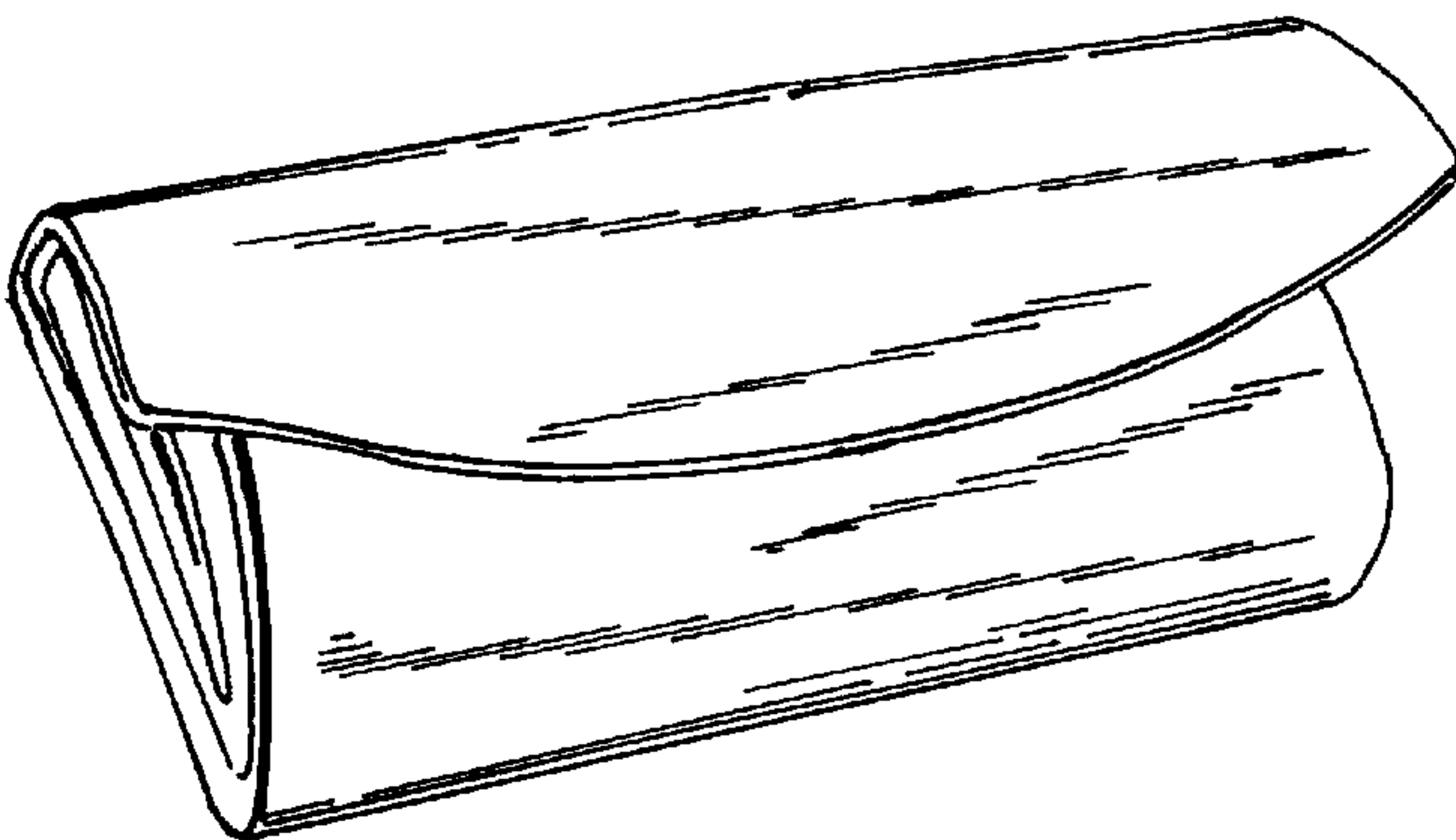

FIG. 3

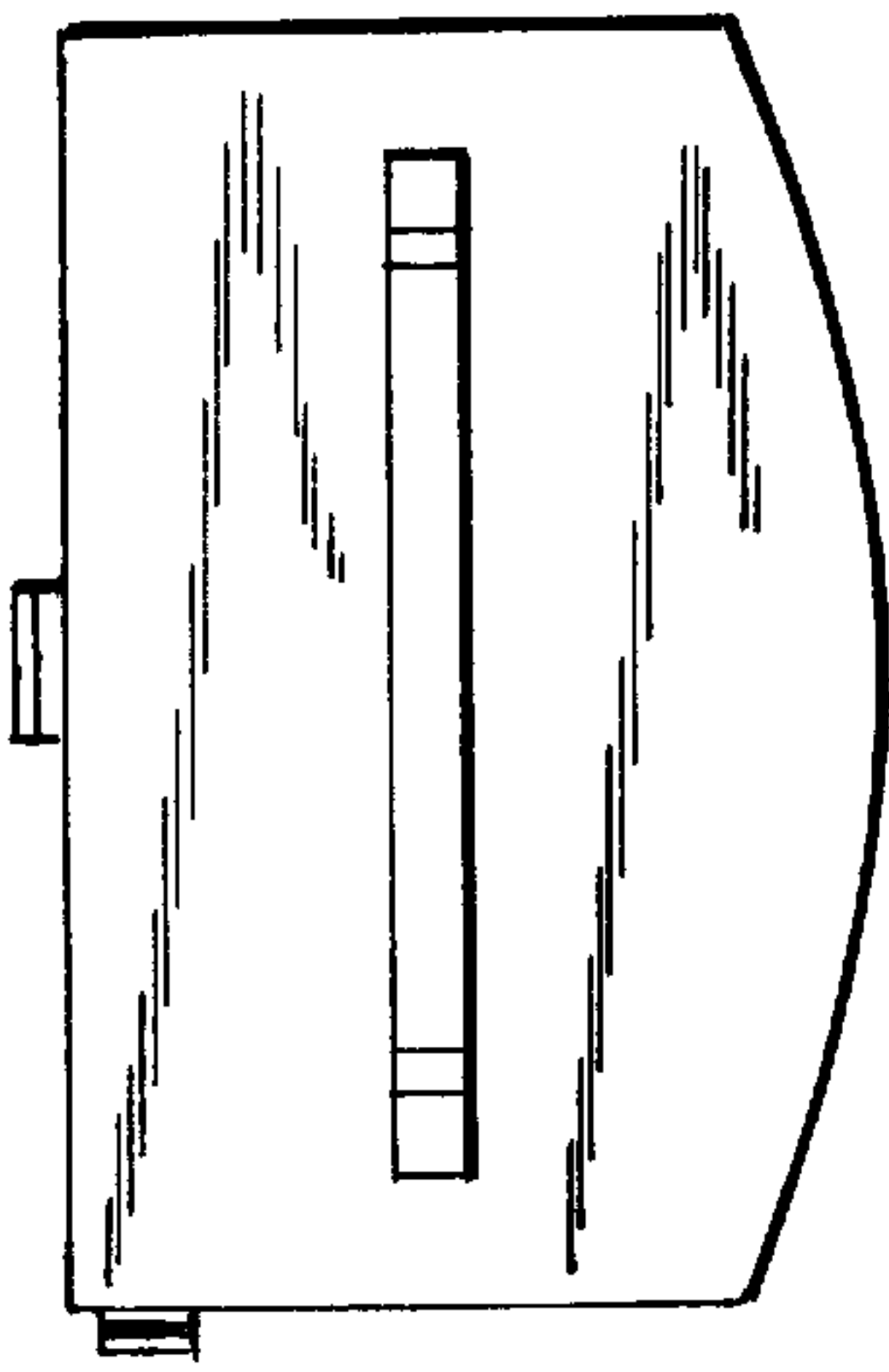

FIG. 4

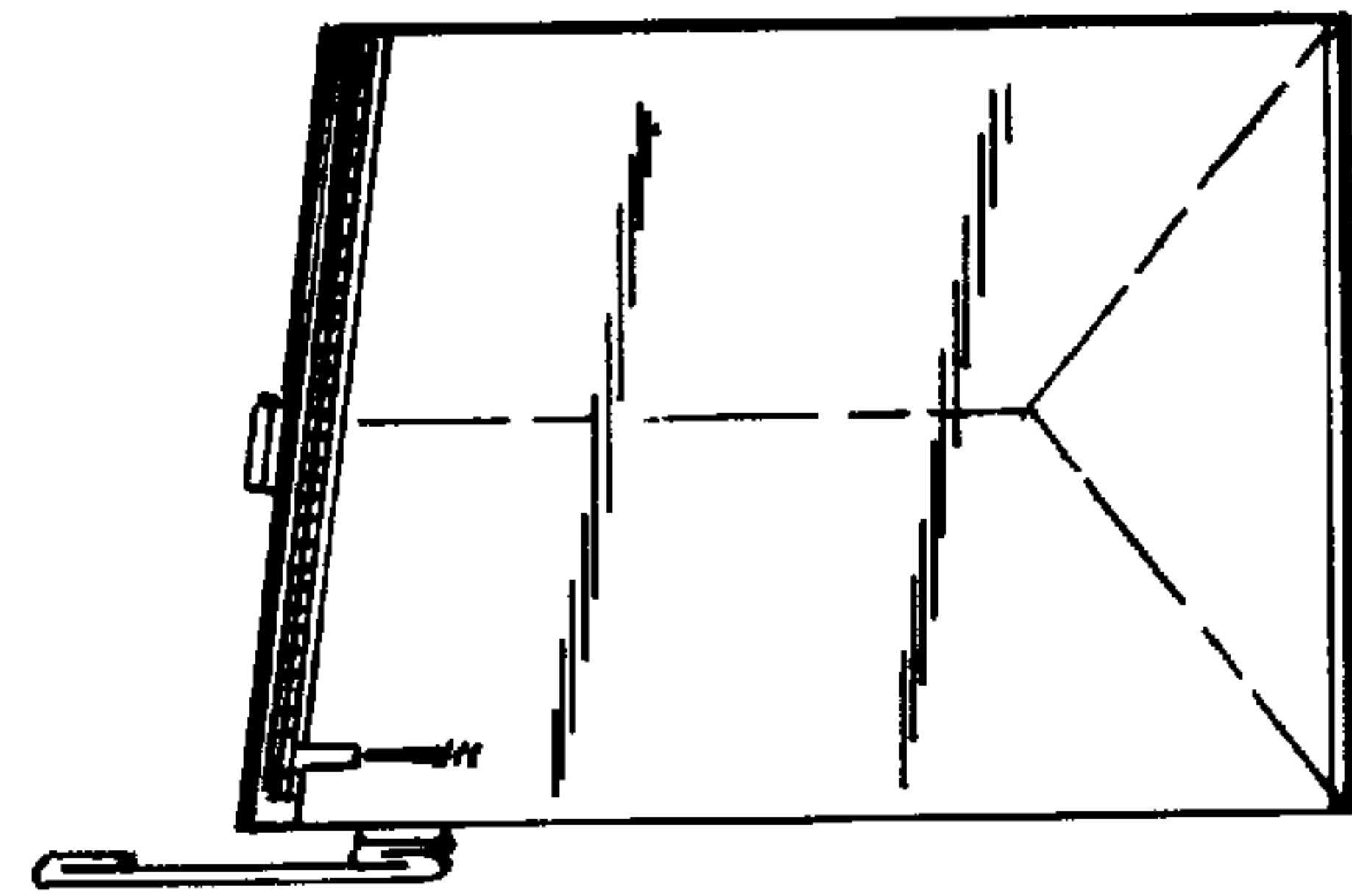

FIG. 5

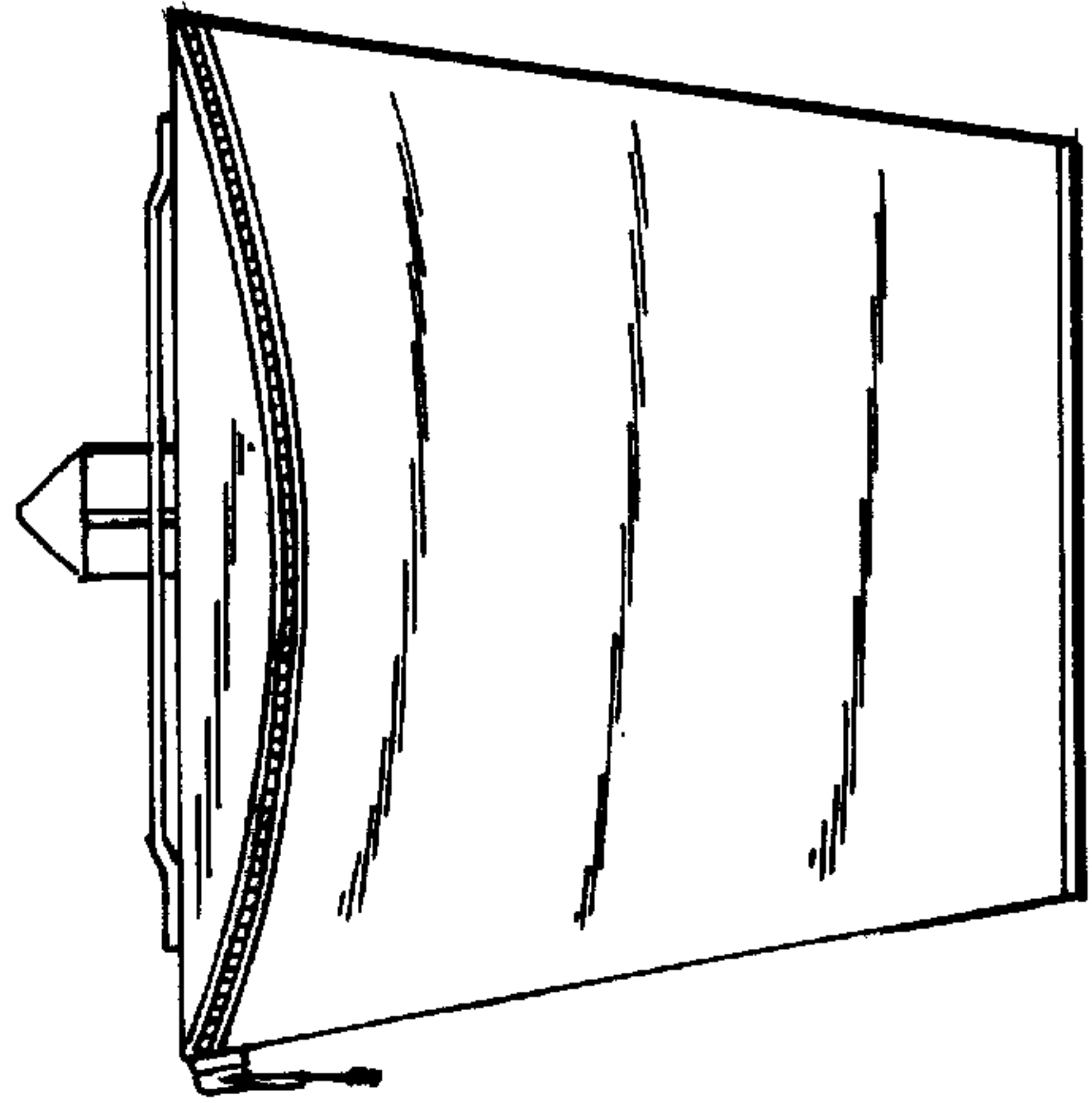

FIG. 6

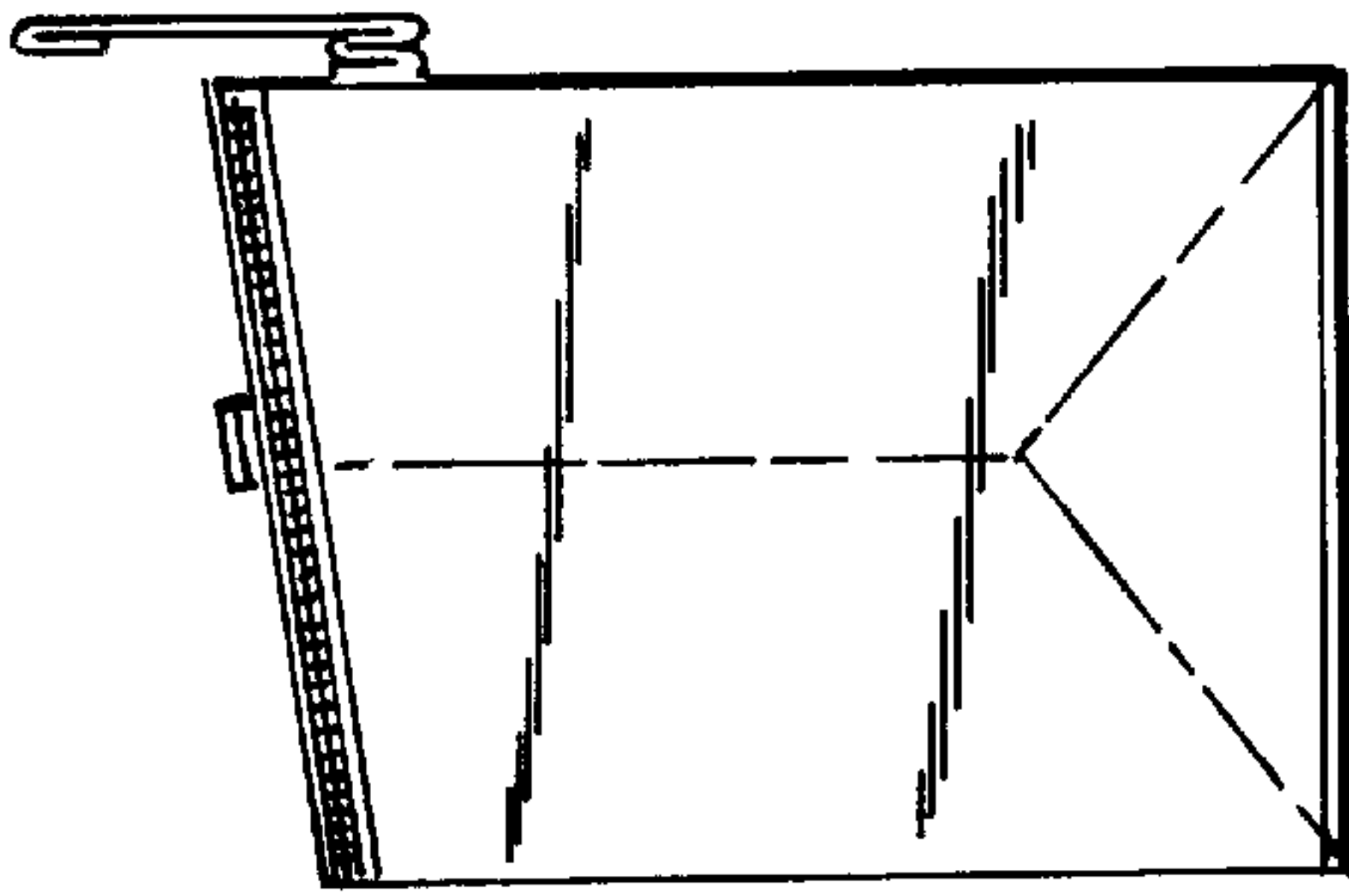

FIG. 7

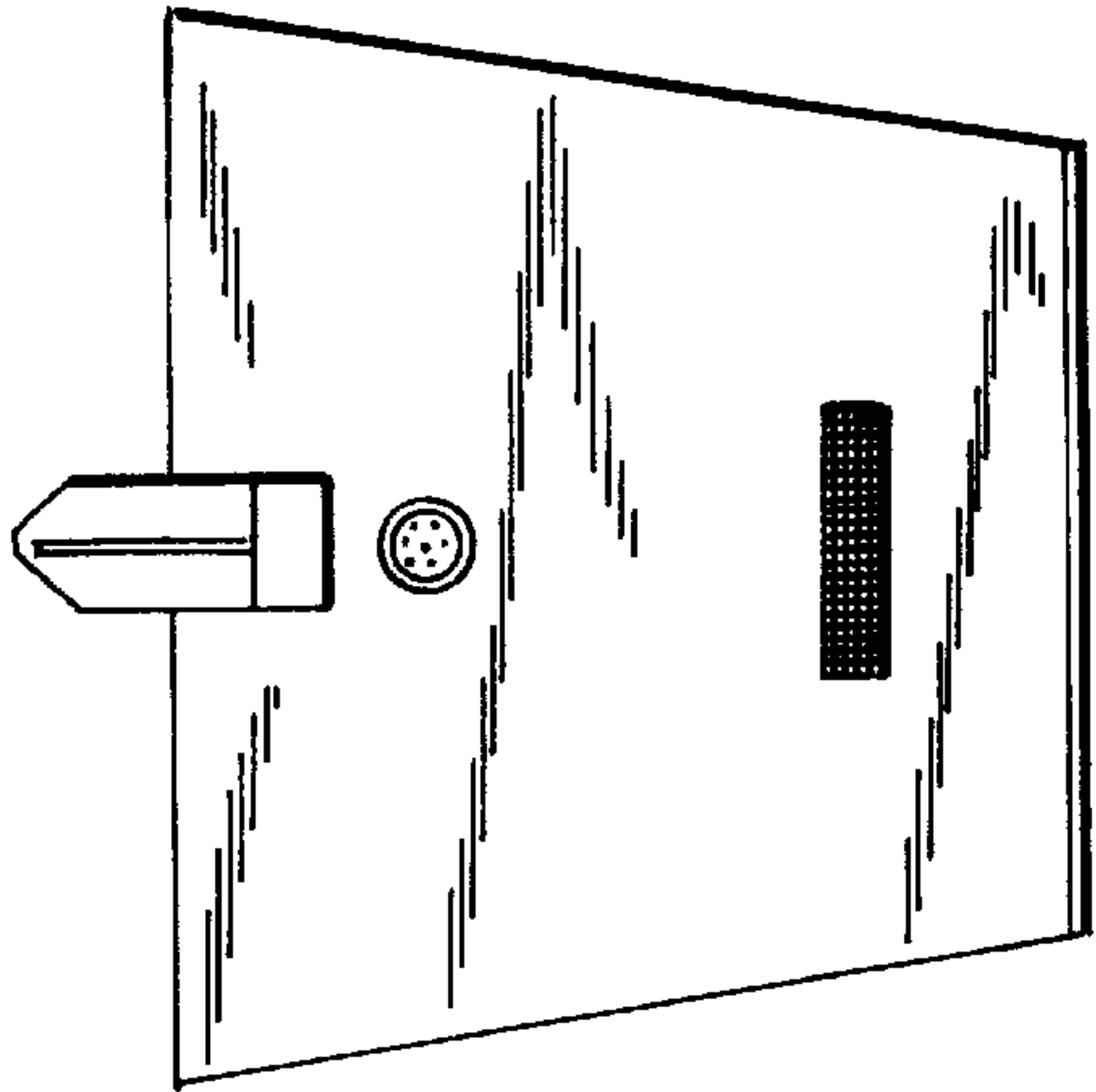

FIG. 8

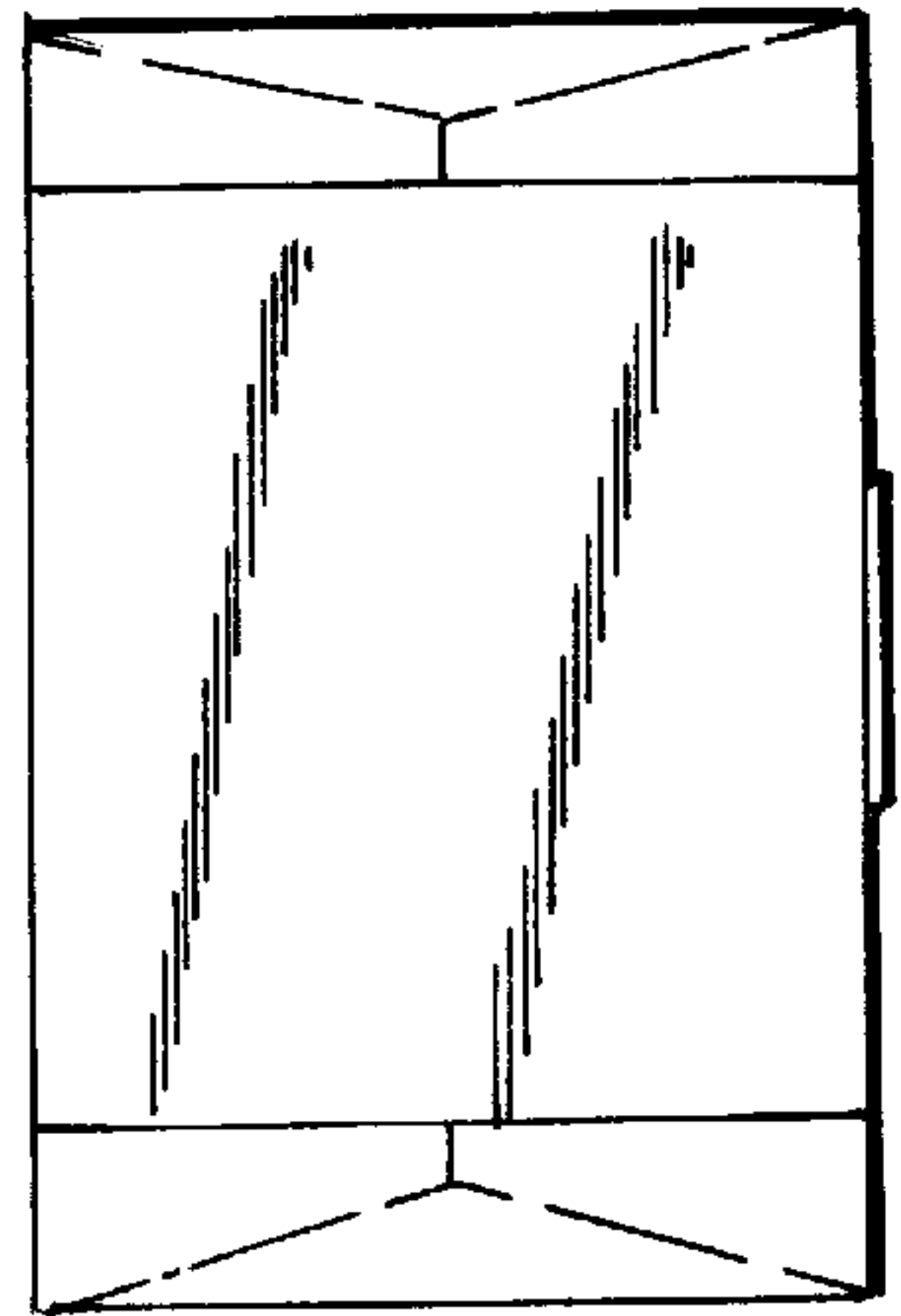

FIG. 9