



US00D432846S

# United States Patent [19]

Parker et al.

[11] Patent Number: Des. 432,846

[45] Date of Patent: \*\* Oct. 31, 2000

[54] **INFANT SUPPORT PILLOW**

[76] Inventors: **Tammy R Parker**, 220 7th St.,  
Dacono, Colo. 80514; **Marvanna R  
Schultz**, 11 Marshall Pl., Longmont,  
Colo. 80501

[\*\*] Term: **14 Years**

[21] Appl. No.: **29/112,714**

[22] Filed: **Oct. 22, 1999**

[51] **LOC (7) Cl.** ..... **06-09**

[52] **U.S. Cl.** ..... **D6/601; D6/596; D6/333**

[58] **Field of Search** ..... D6/595, 596, 601,  
D6/333, 331, 382; 5/630, 633, 636, 652,  
653, 655, 655.9, 637, 922

[56] **References Cited**

**U.S. PATENT DOCUMENTS**

D. 389,359	1/1998	Nowak	.....	D6/601
3,811,140	5/1974	Burpo	.....	5/632
5,584,302	12/1996	Sillaway et al.	.....	128/845

*Primary Examiner*—Janice E. Seeger

[57] **CLAIM**

The ornamental design for a infant support pillow, as shown and described.

**DESCRIPTION**

FIG. 1 is a front elevational view of the infant support pillow of the present invention;  
 FIG. 2 is a rear elevational view of the infant support pillow of FIG. 1;  
 FIG. 3 is a left side elevational view of the infant support pillow of FIG. 1;  
 FIG. 4 is a right side elevational view of the infant support pillow of FIG. 1;  
 FIG. 5 is a top plan view of the infant support pillow of FIG. 1;  
 FIG. 6 is a bottom plan view of the infant support pillow of FIG. 1; and,  
 FIG. 7 is a top, front, right side perspective view of the infant support pillow of FIG. 1.

**1 Claim, 4 Drawing Sheets**

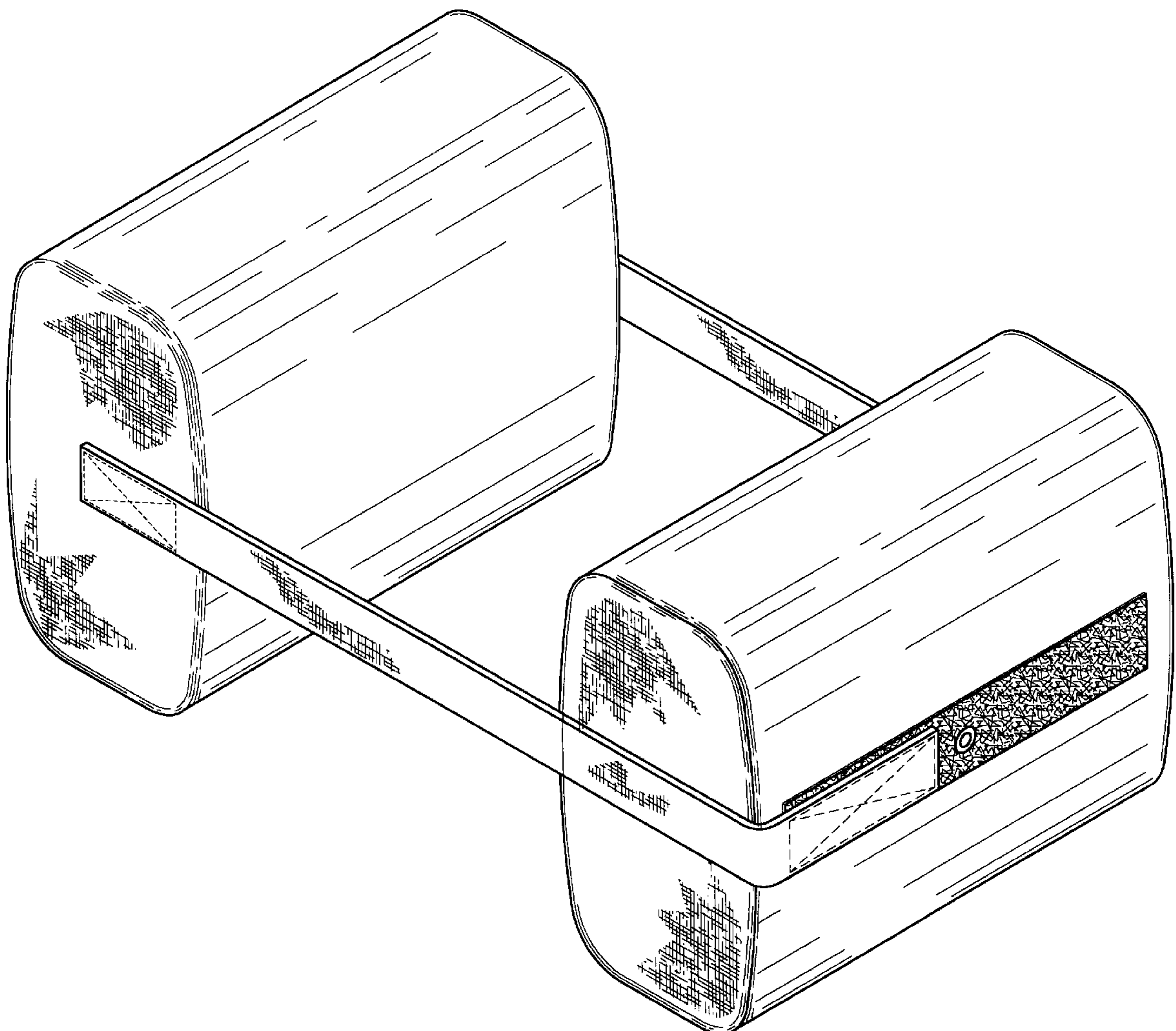

FIG. 1

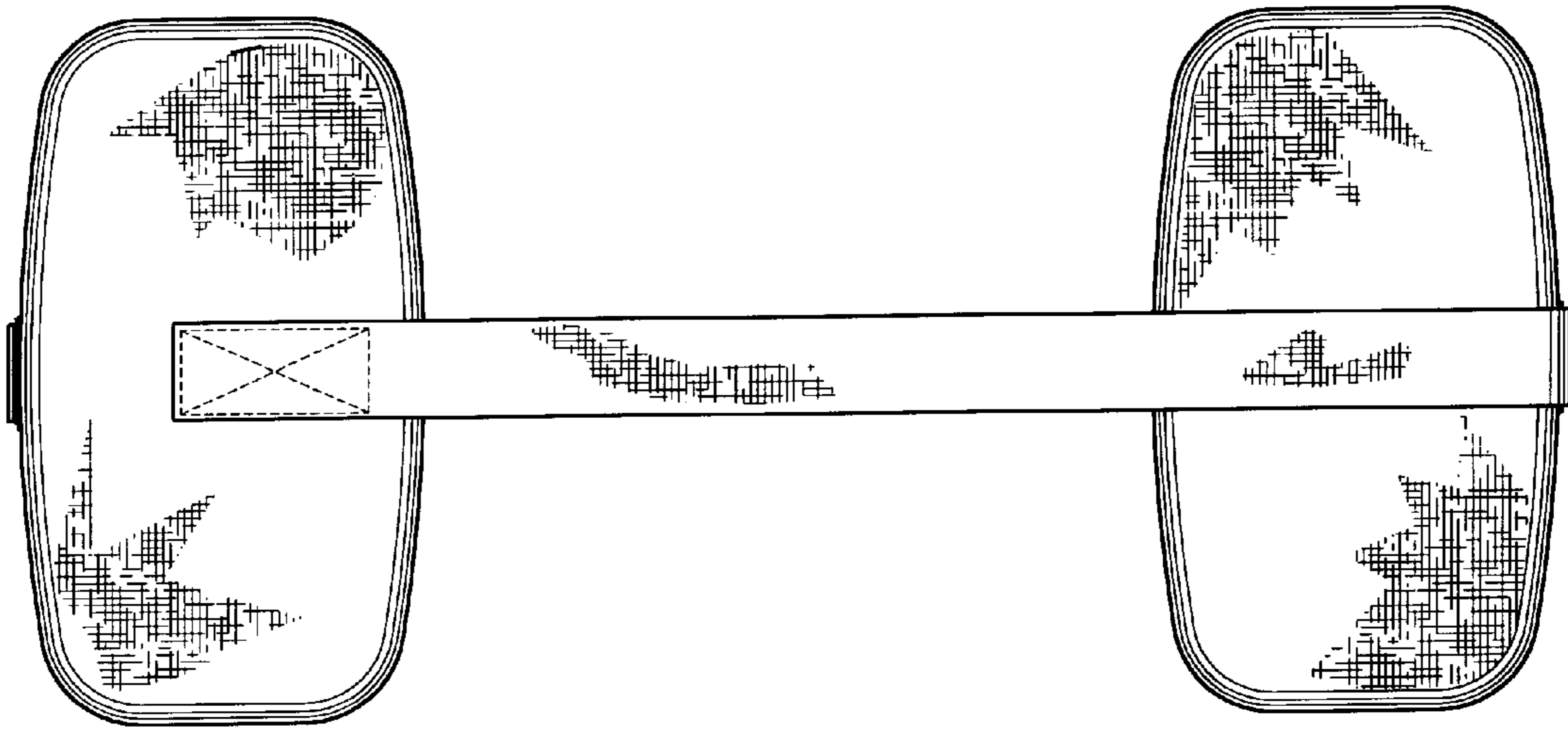

FIG. 2

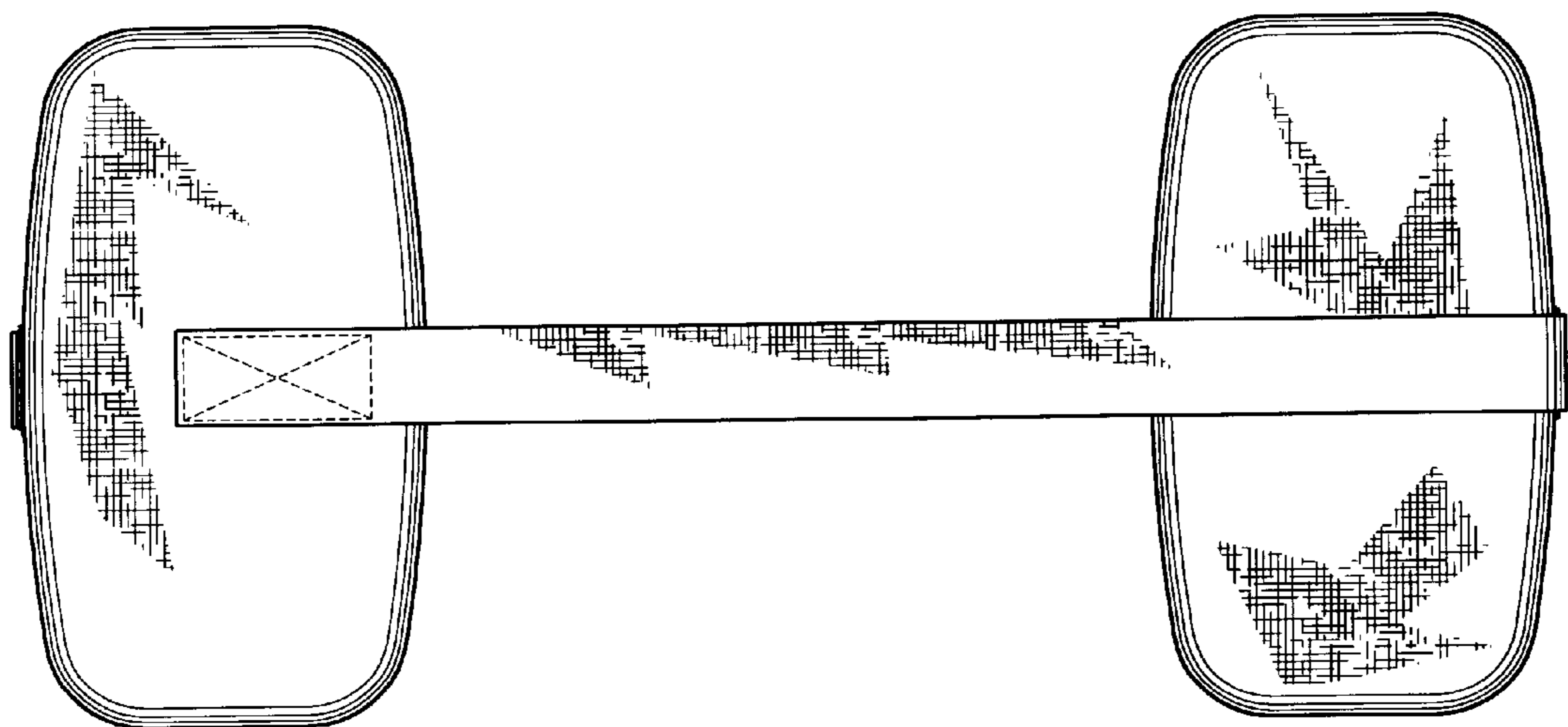

FIG. 3

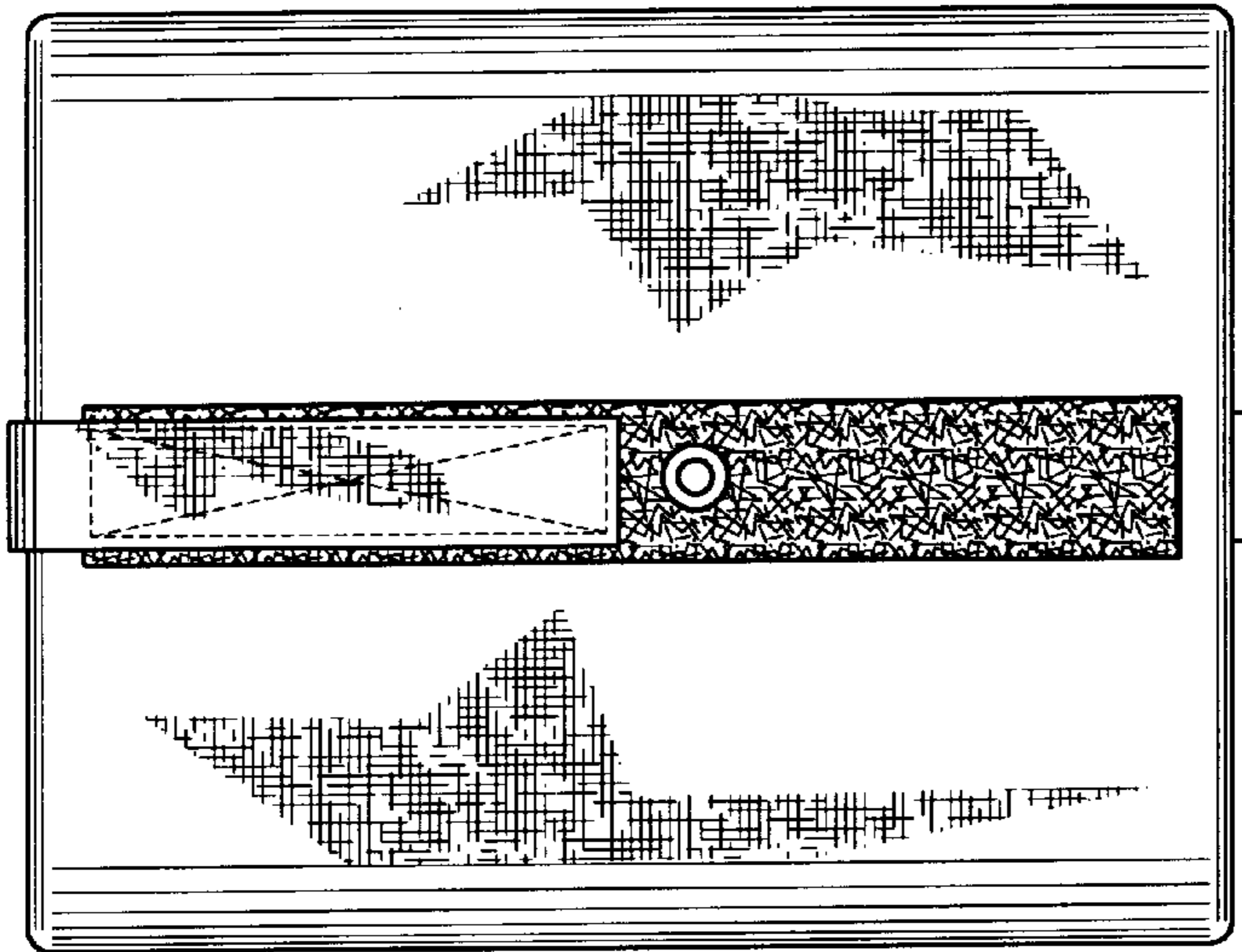

FIG. 4

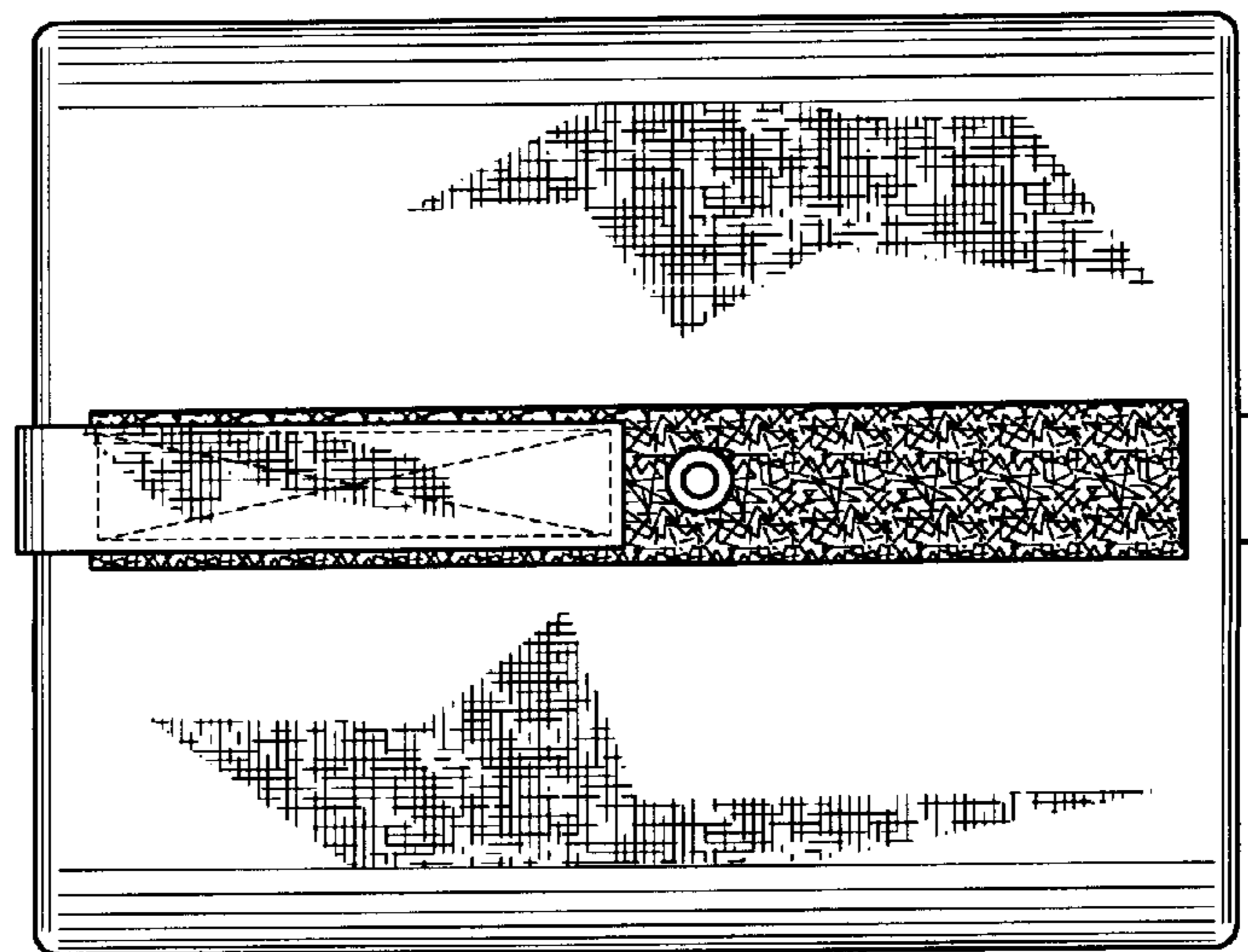

FIG. 5

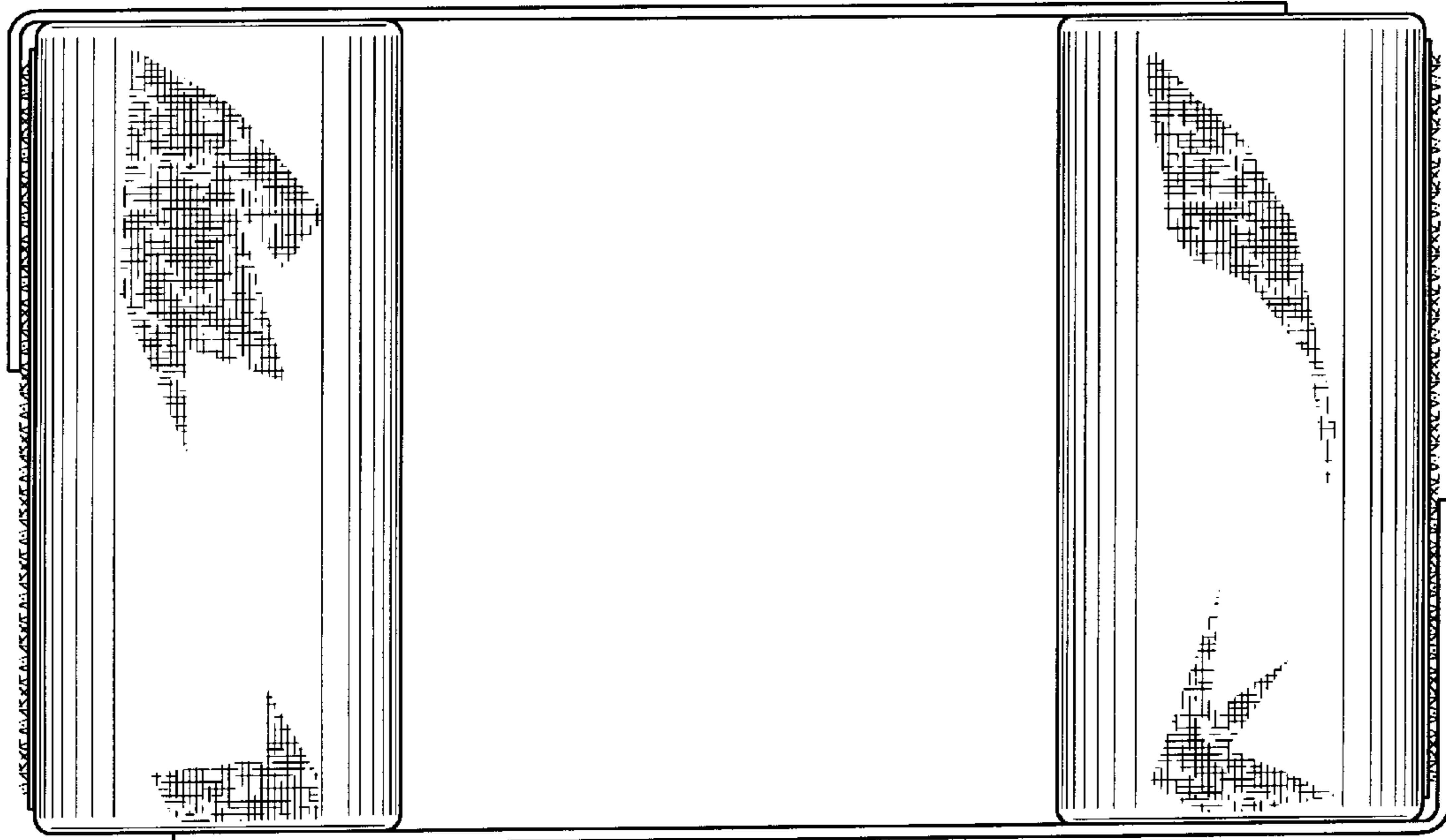

FIG. 6

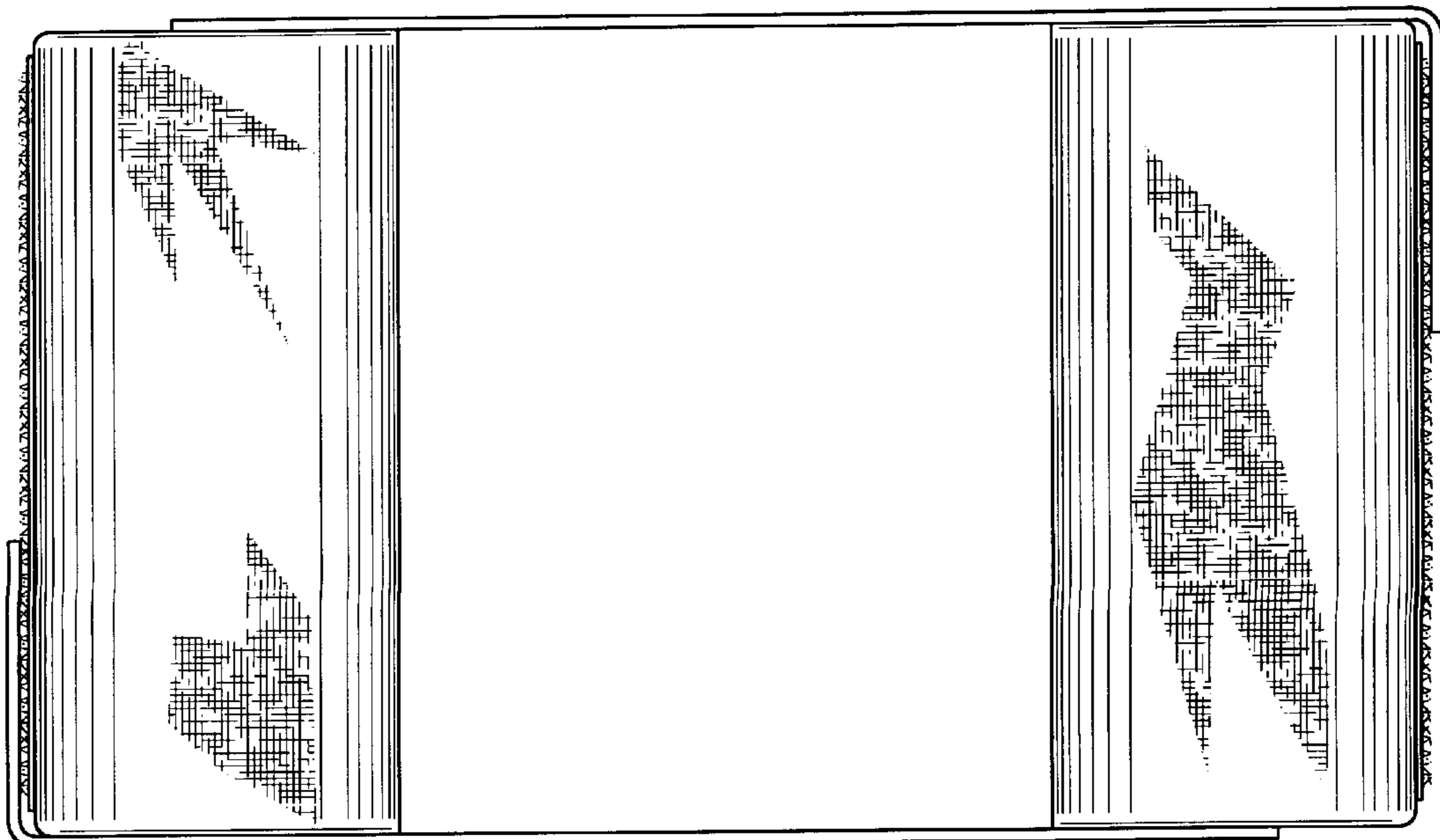

FIG. 7

