



US00D432827S

United States Patent [19]
Lillelund et al.

[11] **Patent Number: Des. 432,827**
[45] **Date of Patent: ** Oct. 31, 2000**

[54] **PAPER TOWEL DISPENSER**
[75] Inventors: **Stig Lillelund**, Gentofte; **Jakob Heiberg**, Charlottenlund, both of Denmark
[73] Assignee: **Dart Industries Inc.**, Orlando, Fla.
[**] Term: **14 Years**
[21] Appl. No.: **29/111,180**
[22] Filed: **Sep. 22, 1999**
[51] **LOC (7) Cl.** **20-02**
[52] **U.S. Cl.** **D6/521; D6/522**
[58] **Field of Search** D6/518, 521, 522; 206/389; 211/59.1; 222/174; 242/570, 590, 597; 248/309.1, 309.2

D. 356,226 3/1995 Hay D6/521
D. 359,642 6/1995 Ahern, Jr. D6/521
D. 373,918 9/1996 Jorgenson D6/521
D. 390,054 2/1998 Goodman D6/522
D. 394,770 6/1998 Dann, Jr. D6/521
D. 405,304 2/1999 Goodman et al. D6/521
D. 405,633 2/1999 Joergensen D6/522

Primary Examiner—Brian N. Vinson
Attorney, Agent, or Firm—Taylor J. Ross

[57] **CLAIM**

The ornamental design for a paper towel dispenser, as shown and described.

DESCRIPTION

FIG. 1 is a top, side and front perspective view of a paper towel dispenser showing the new design; FIG. 2 is a bottom, side and front perspective view thereof; FIG. 3 is a rear elevation view thereof; FIG. 4 is a front elevation view thereof; FIG. 5 is a left side elevation view thereof; FIG. 6 is a right side elevation view thereof; FIG. 7 is a top plan view thereof; and, FIG. 8 is a bottom plan view thereof.

[56] **References Cited**
U.S. PATENT DOCUMENTS
D. 253,209 10/1979 Hayslett D6/521
D. 260,061 8/1981 Smith D6/96
D. 284,152 6/1986 Jerhammar D6/521
D. 298,597 11/1988 Bell D6/521
D. 306,809 3/1990 Joseph D6/521

1 Claim, 4 Drawing Sheets

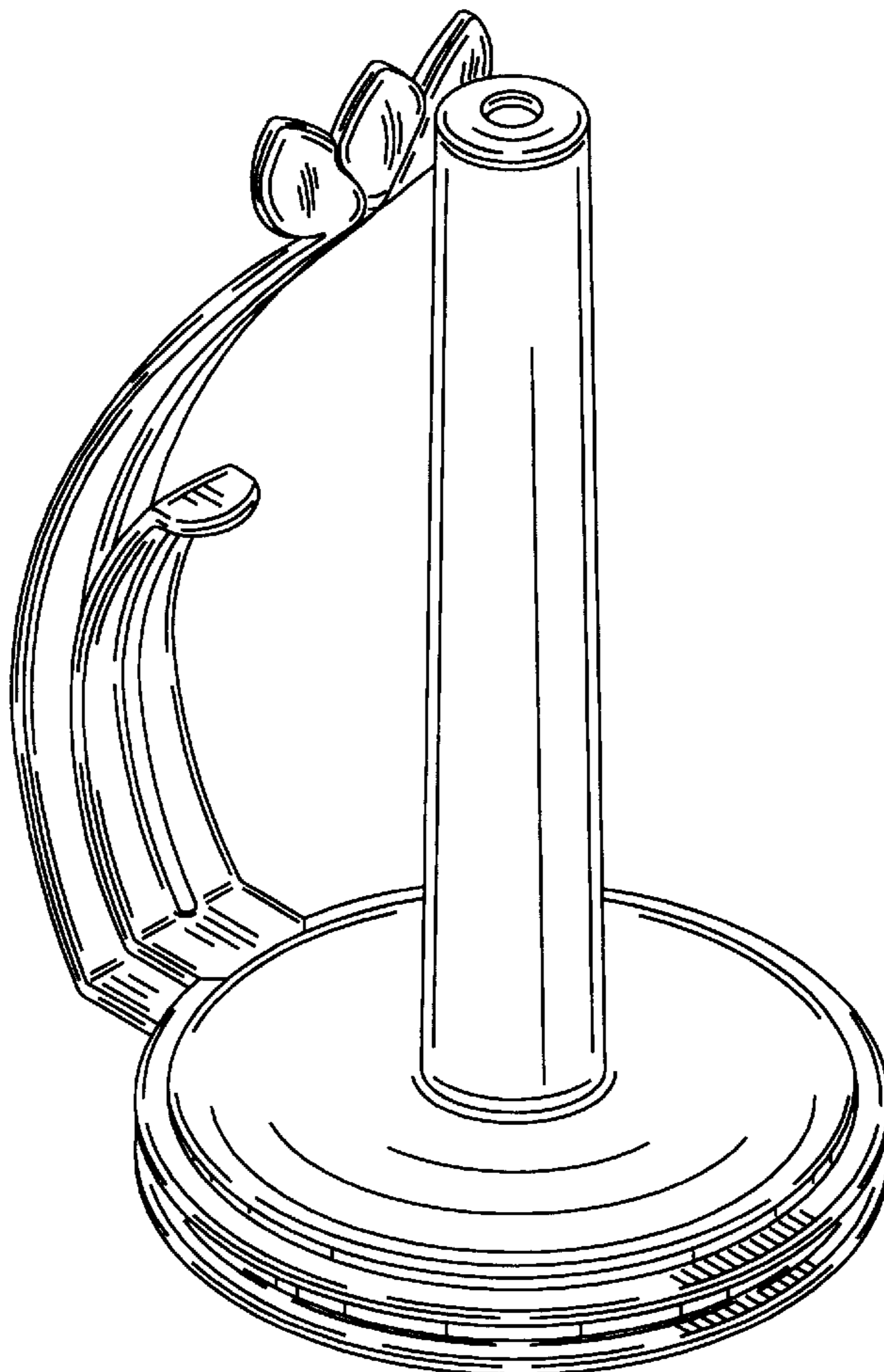

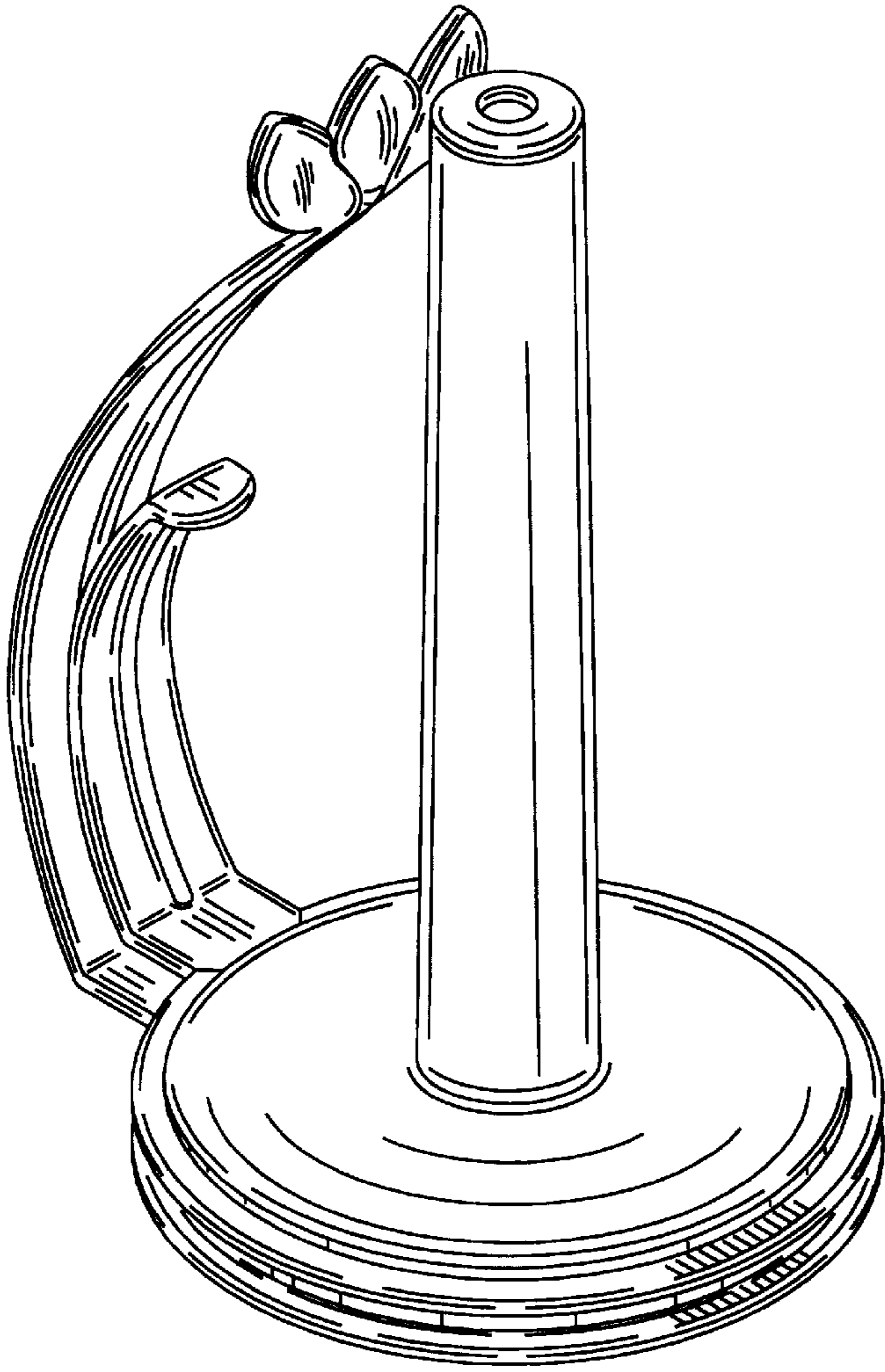

FIG. 1

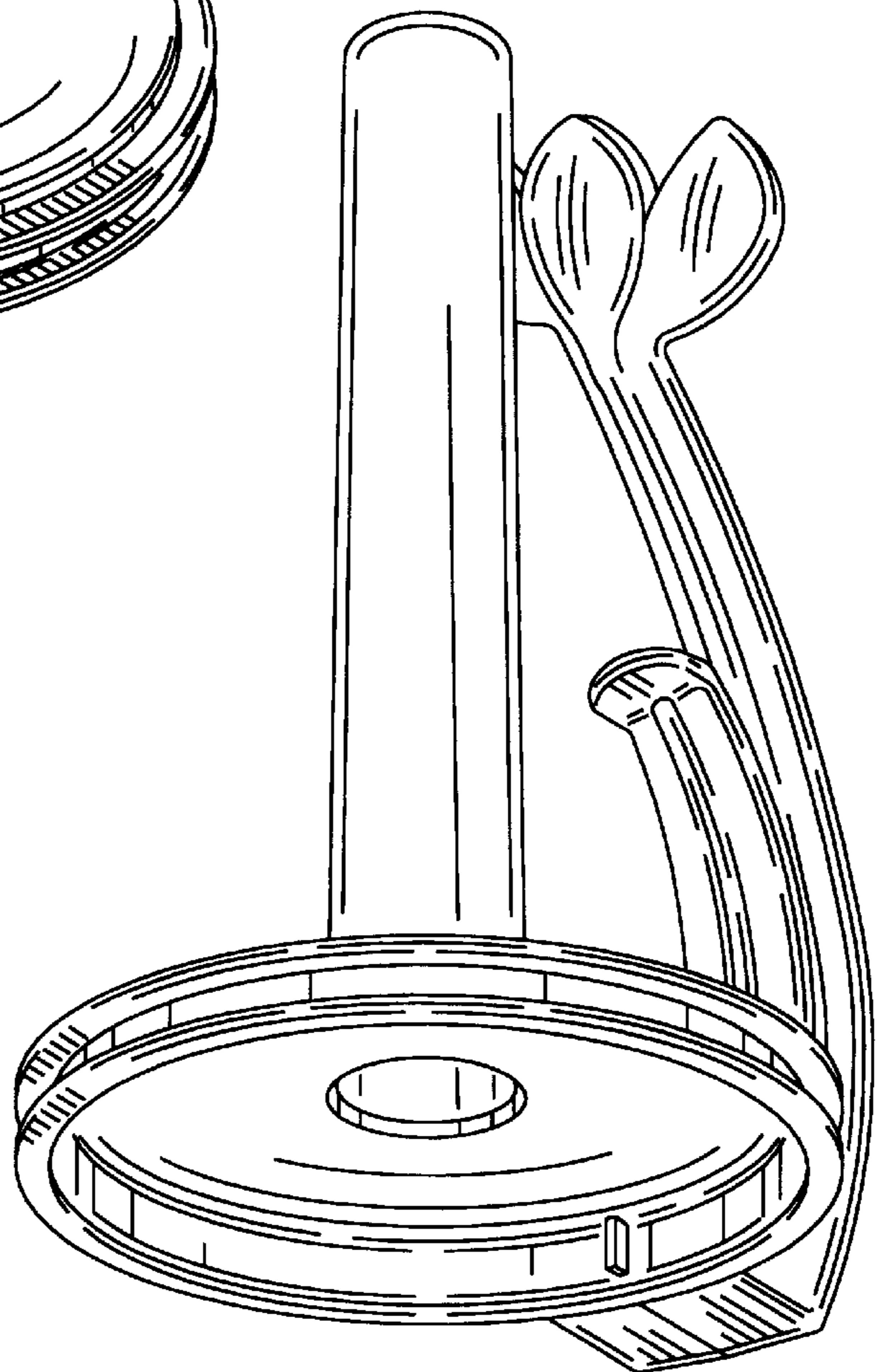

FIG. 2

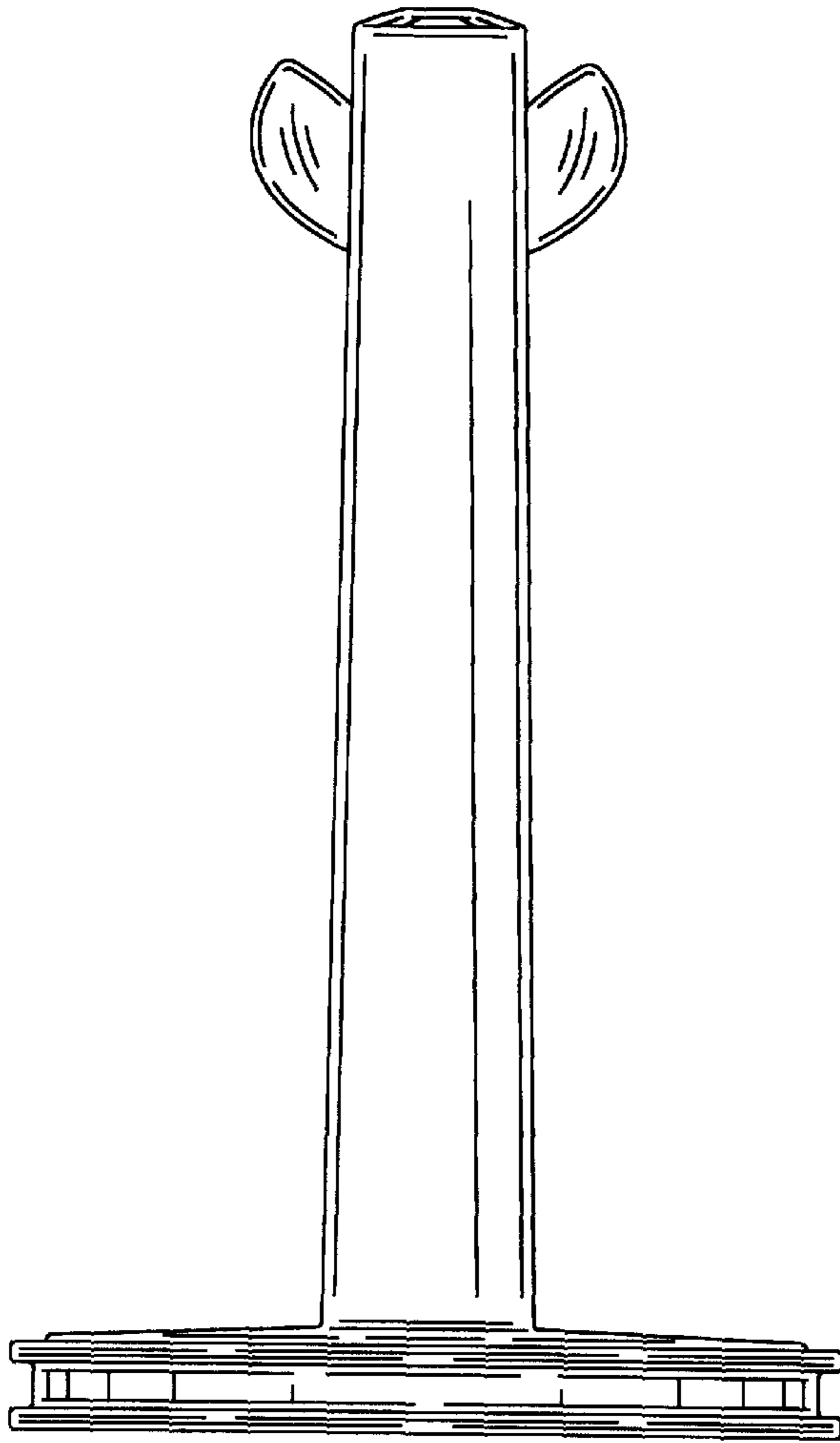

FIG. 3

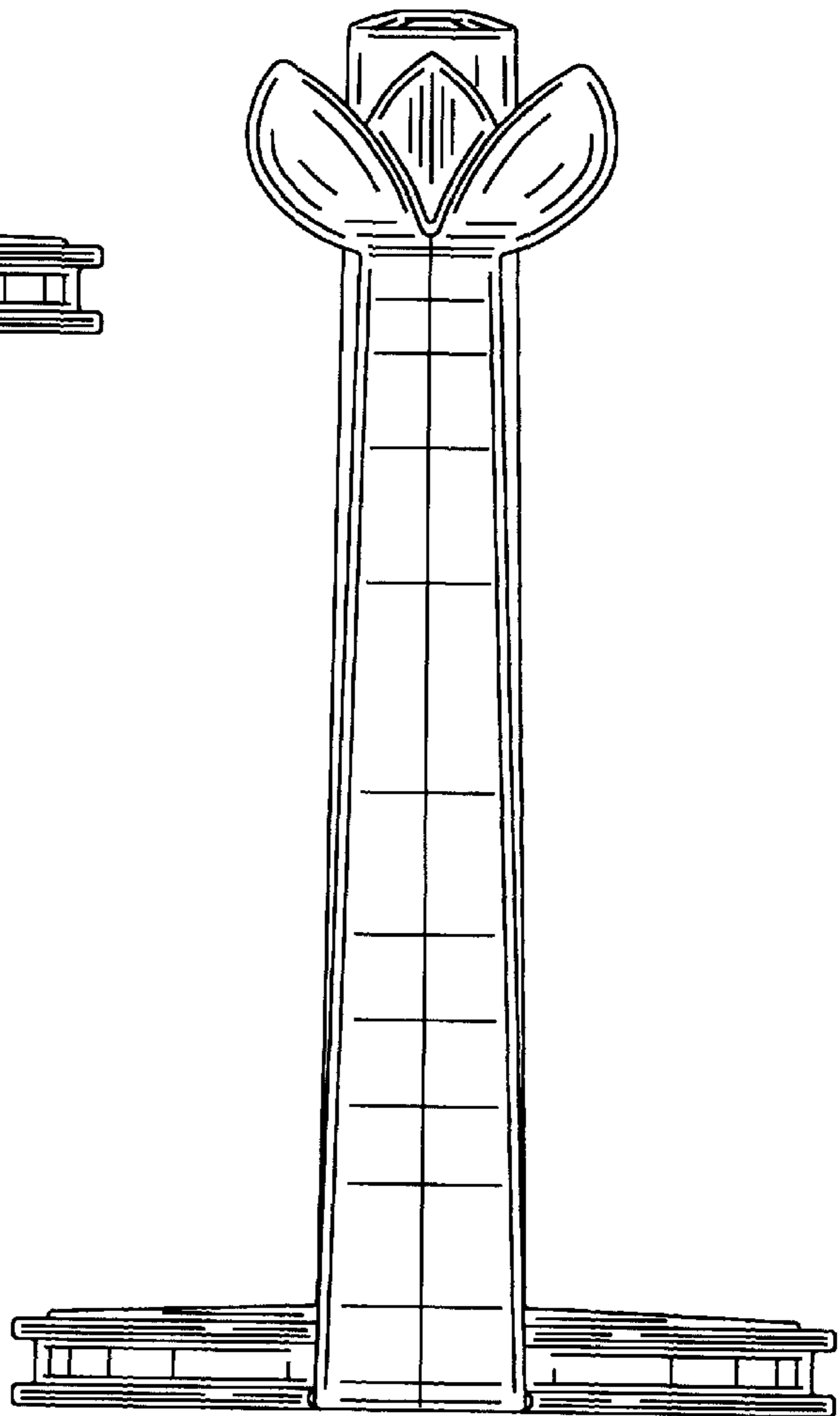

FIG. 4

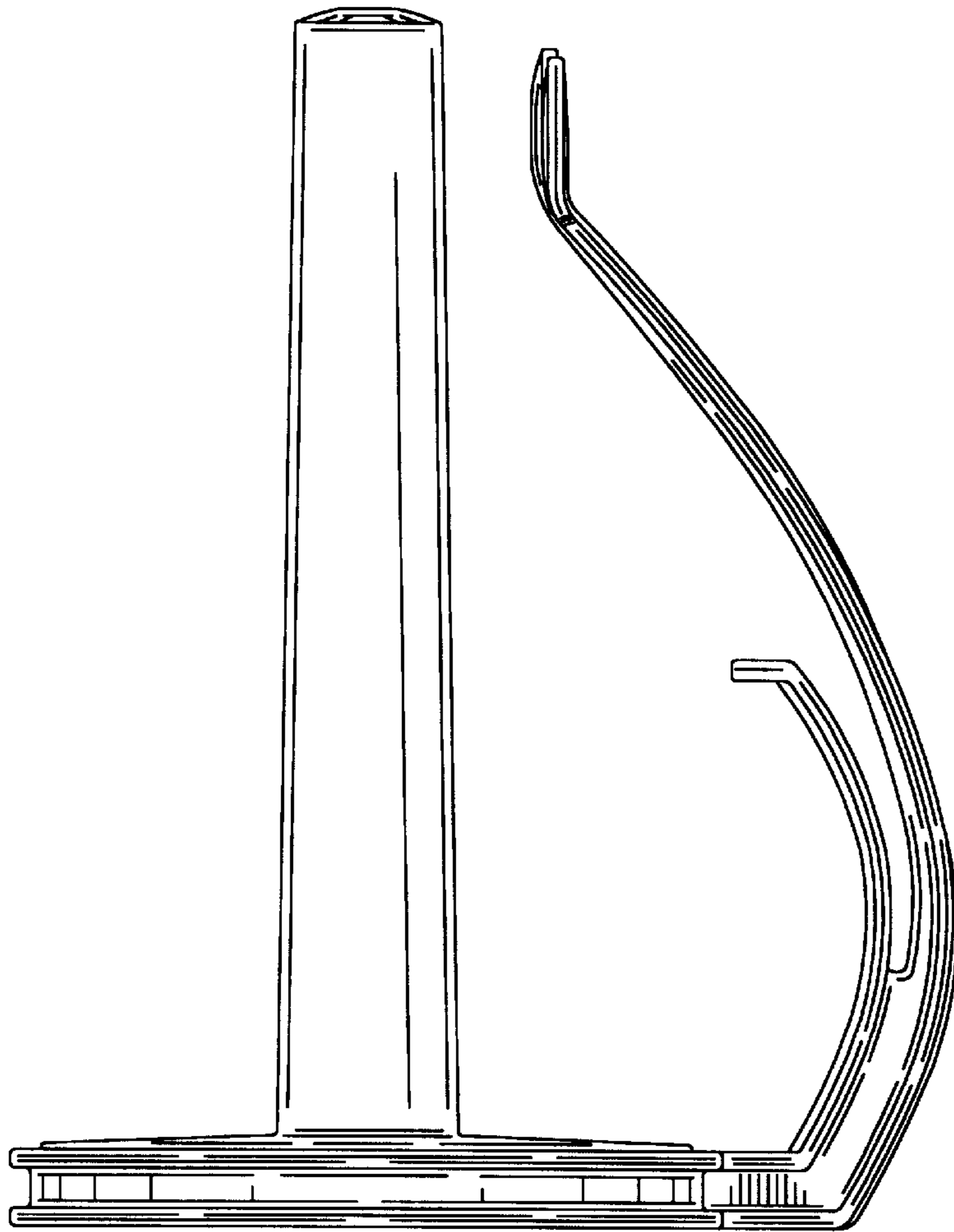

FIG. 5

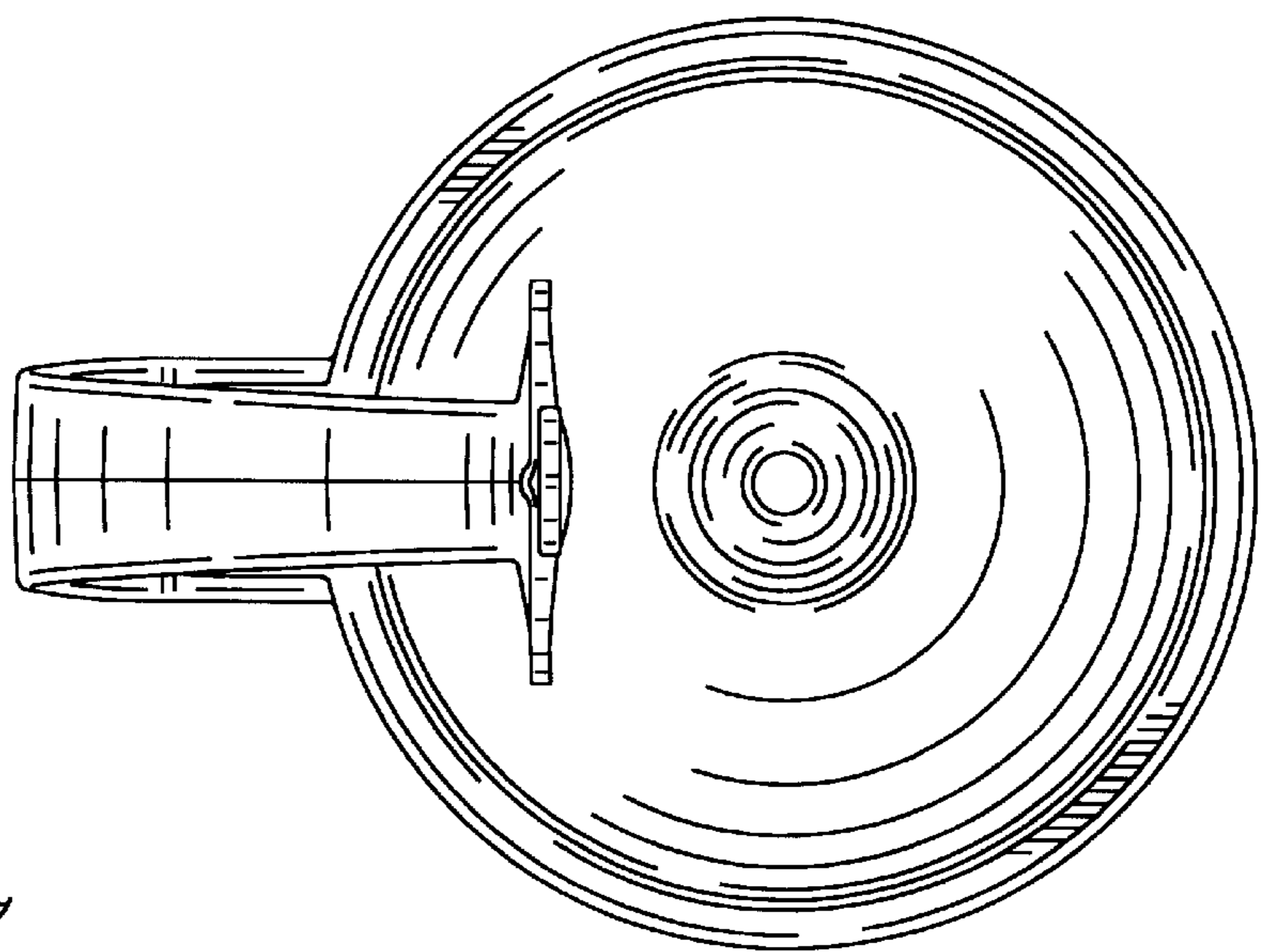

FIG. 7

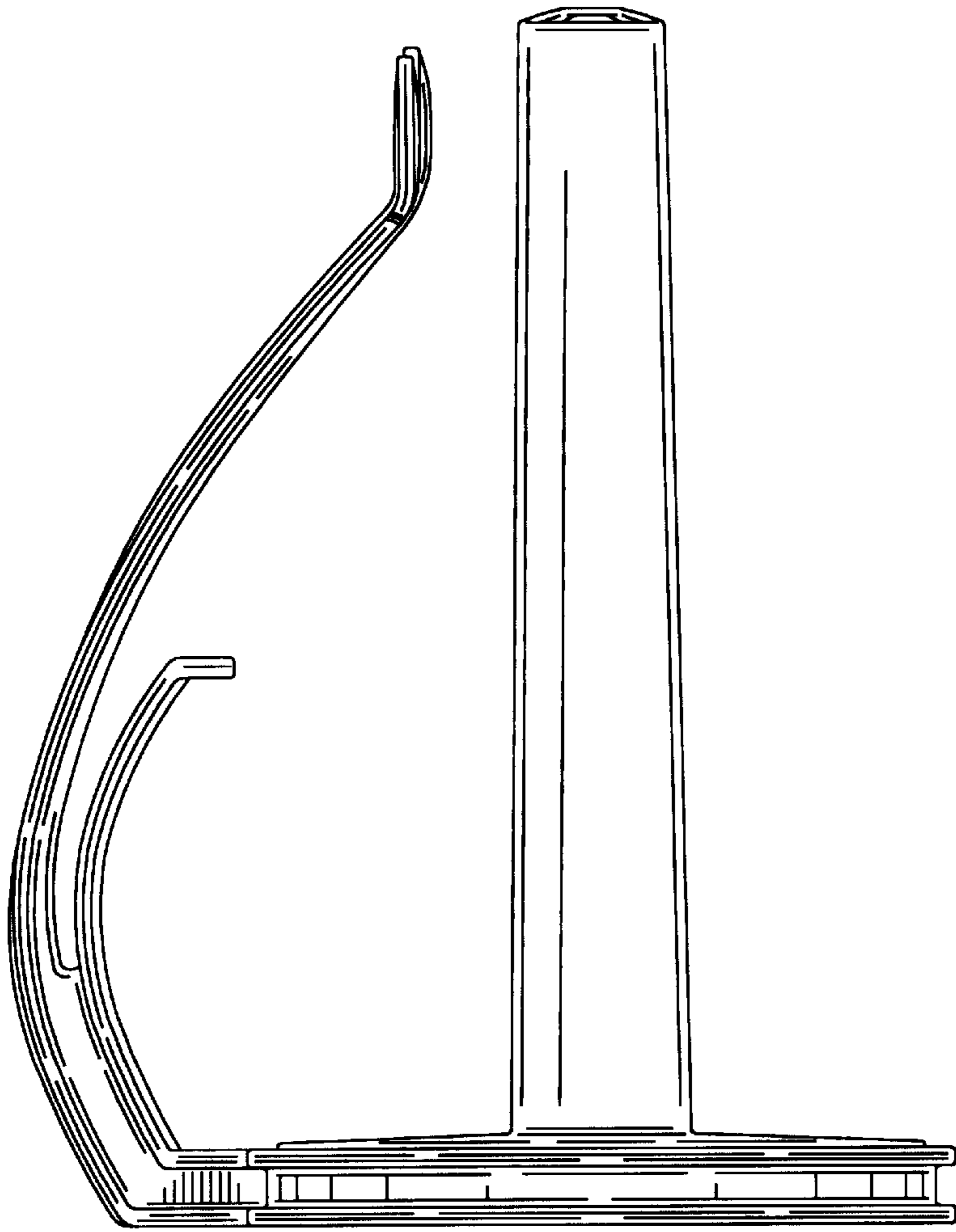

FIG. 6

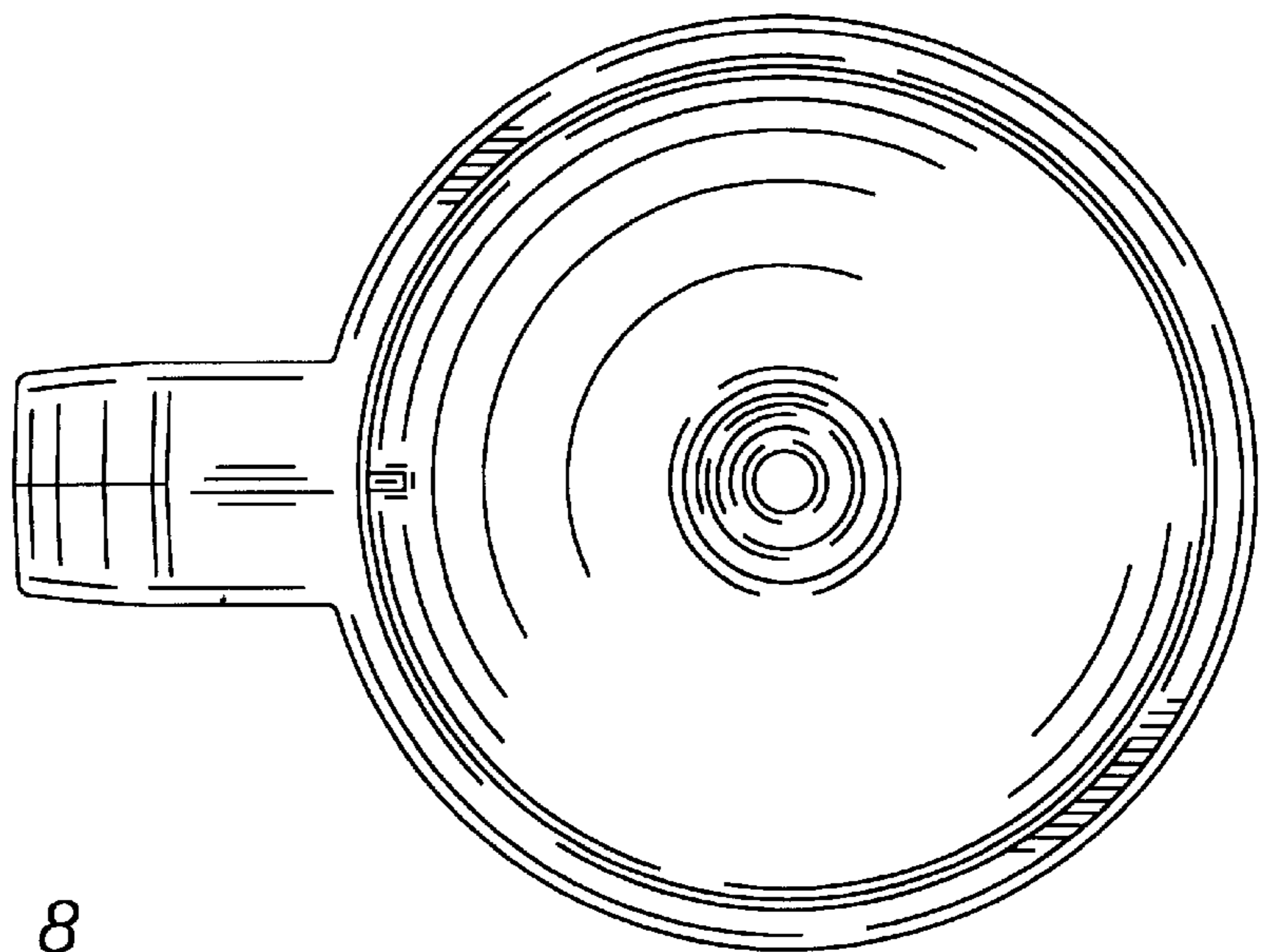

FIG. 8