

US00D432611S

United States Patent [19]

McCabe et al.

[11] Patent Number: Des. 432,611

[45] Date of Patent: ** Oct. 24, 2000

[54] BACK PORTION OF A GOLF CLUB HEAD

[75] Inventors: **Terrill R. McCabe; Peter J. Gilbert,**
both of Carlsbad; **Mike S. Bujdos,**
Oceanside, all of Calif.

[73] Assignee: **Acushnet Company,** Fairhaven, Mass.

[**] Term: **14 Years**

[21] Appl. No.: **29/099,772**

[22] Filed: **Jan. 28, 1999**

[51] **LOC (7) Cl.** **21-02**

[52] **U.S. Cl.** **D21/759**

[58] **Field of Search** D21/747-751,
D21/753, 759; 473/324, 350

| | | |
|-----------|---------|--------------------|
| 4,957,294 | 9/1990 | Long . |
| 5,048,834 | 9/1991 | Gorman . |
| 5,056,788 | 10/1991 | Katayama . |
| 5,082,278 | 1/1992 | Hsien . |
| 5,333,872 | 8/1994 | Manning et al. . |
| 5,344,150 | 9/1994 | Schmidt et al. . |
| 5,346,213 | 9/1994 | Yamada . |
| 5,356,138 | 10/1994 | Chen et al. . |
| 5,375,840 | 12/1994 | Hirsch et al. . |
| 5,395,113 | 3/1995 | Antonious . |
| 5,407,202 | 4/1995 | Igarashi . |
| 5,411,264 | 5/1995 | Oku . |
| 5,423,534 | 6/1995 | Solheim . |
| 5,423,546 | 6/1995 | Manning et al. . |
| 5,429,353 | 7/1995 | Hoeflich . |
| 5,522,593 | 6/1996 | Kobayashi et al. . |
| 5,562,551 | 10/1996 | Rife . |
| 5,658,209 | 8/1997 | Blakemore . |
| 5,669,824 | 9/1997 | Aizawa et al. . |
| 5,674,133 | 10/1997 | Chang et al. . |
| 5,792,005 | 8/1998 | Sieleman et al. . |

[56] References Cited

U.S. PATENT DOCUMENTS

| | | | |
|------------|---------|--------------------|---------|
| D. 164,596 | 9/1951 | Penna . | |
| D. 264,488 | 5/1982 | Kobayashi . | |
| D. 323,689 | 2/1992 | Hardman et al. . | |
| D. 323,690 | 2/1992 | Hlinka . | |
| D. 327,109 | 6/1992 | Hardman et al. . | |
| D. 332,984 | 2/1993 | Iinuma et al. . | |
| D. 353,644 | 12/1994 | Hirsch et al. . | |
| D. 361,358 | 8/1995 | Simmons . | |
| D. 362,884 | 10/1995 | Blough et al. . | |
| D. 362,885 | 10/1995 | Blough et al. . | |
| D. 362,887 | 10/1995 | Blough et al. . | |
| D. 364,434 | 11/1995 | McGraw et al. . | |
| D. 368,753 | 4/1996 | Blough et al. . | |
| D. 370,514 | 6/1996 | Blough et al. . | |
| D. 383,820 | 9/1997 | Watanabe . | |
| D. 386,549 | 11/1997 | Takahashi et al. . | |
| D. 392,706 | 3/1998 | Stites, III . | |
| D. 394,290 | 5/1998 | Best et al. . | |
| D. 401,637 | 11/1998 | Best et al. | D21/747 |
| D. 404,783 | 1/1999 | Best et al. | D21/747 |
| D. 413,369 | 8/1999 | Peng | D21/748 |
| D. 417,248 | 11/1999 | Matauo | D21/748 |
| 2,254,528 | 9/1941 | Hoare . | |
| 3,655,188 | 4/1972 | Solheim . | |
| 4,420,156 | 12/1983 | Campau . | |
| 4,715,601 | 12/1987 | Lamanna . | |
| 4,802,672 | 2/1989 | Long . | |
| 4,858,929 | 8/1989 | Long . | |
| 4,883,274 | 11/1989 | Hsien . | |

FOREIGN PATENT DOCUMENTS

9-285571 5/1996 Japan .

Primary Examiner—Mitchell Siegel
Attorney, Agent, or Firm—Pennie & Edmonds LLP

[57] CLAIM

The ornamental design for back portion of a golf club head, as shown and described.

DESCRIPTION

FIG. 1 is a rear perspective view, toward the toe of a back portion of a golf club head showing a rear surface of the new design;

FIG. 2 is a rear perspective view, toward the heel of the back portion of the golf club head showing the rear surface of the new design;

FIG. 3 is a rear view thereof;

FIG. 4 is a bottom view thereof; and

FIG. 5 is a left side heel view thereof; and,

FIG. 6 is a partial enlarged cross sectional view taken on line 6—6 of FIG. 3.

The broken line showing of the club head of FIGS. 1-5 is for illustrative purposes only and forms no part of the claimed design.

1 Claim, 2 Drawing Sheets

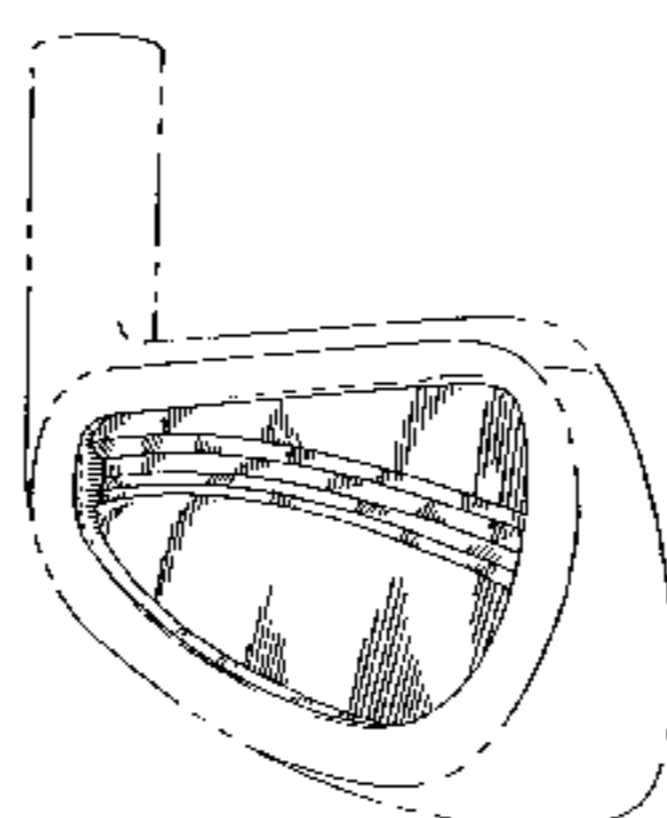
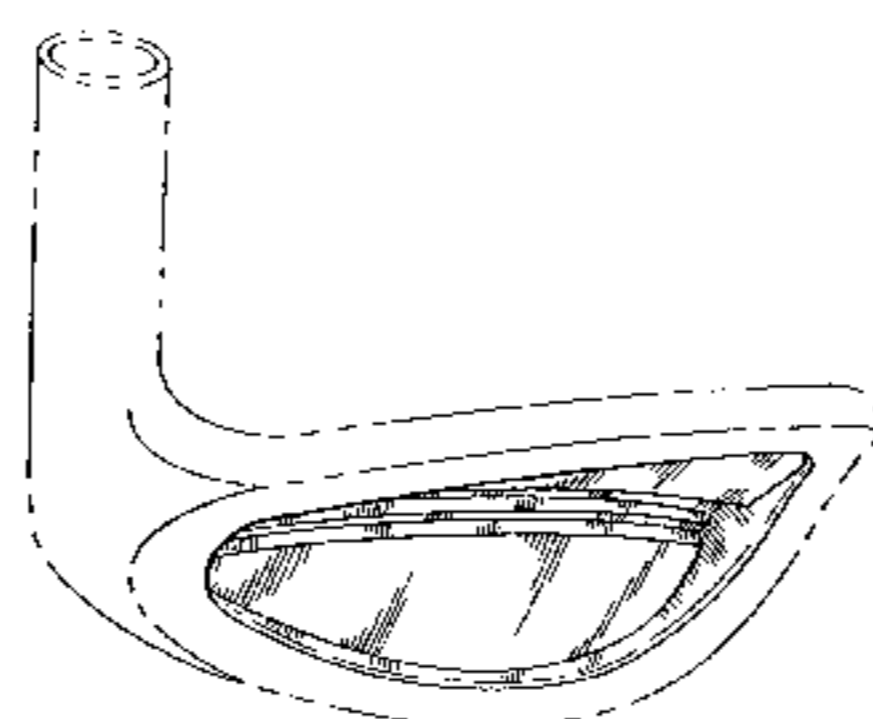

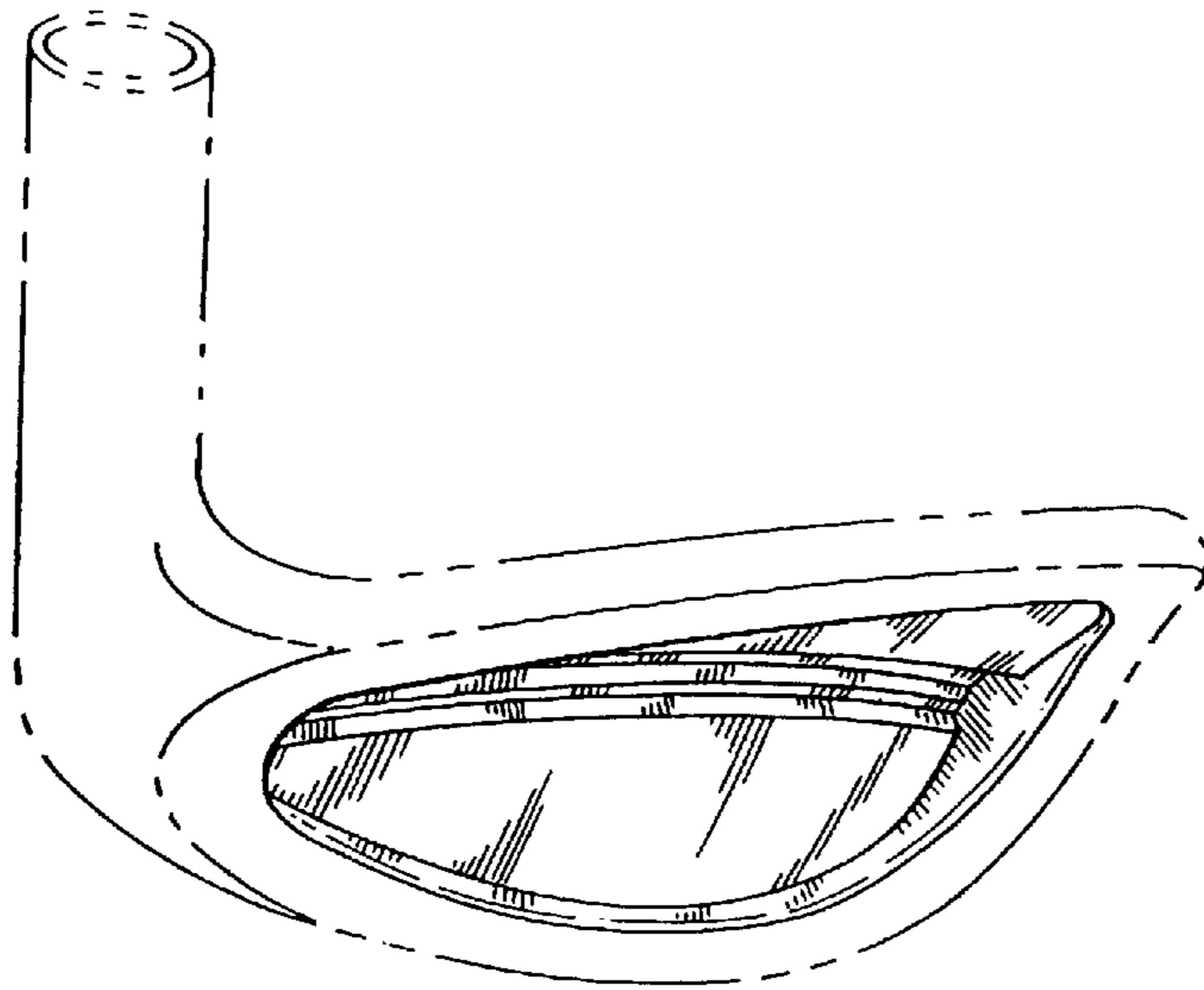

Fig. 1

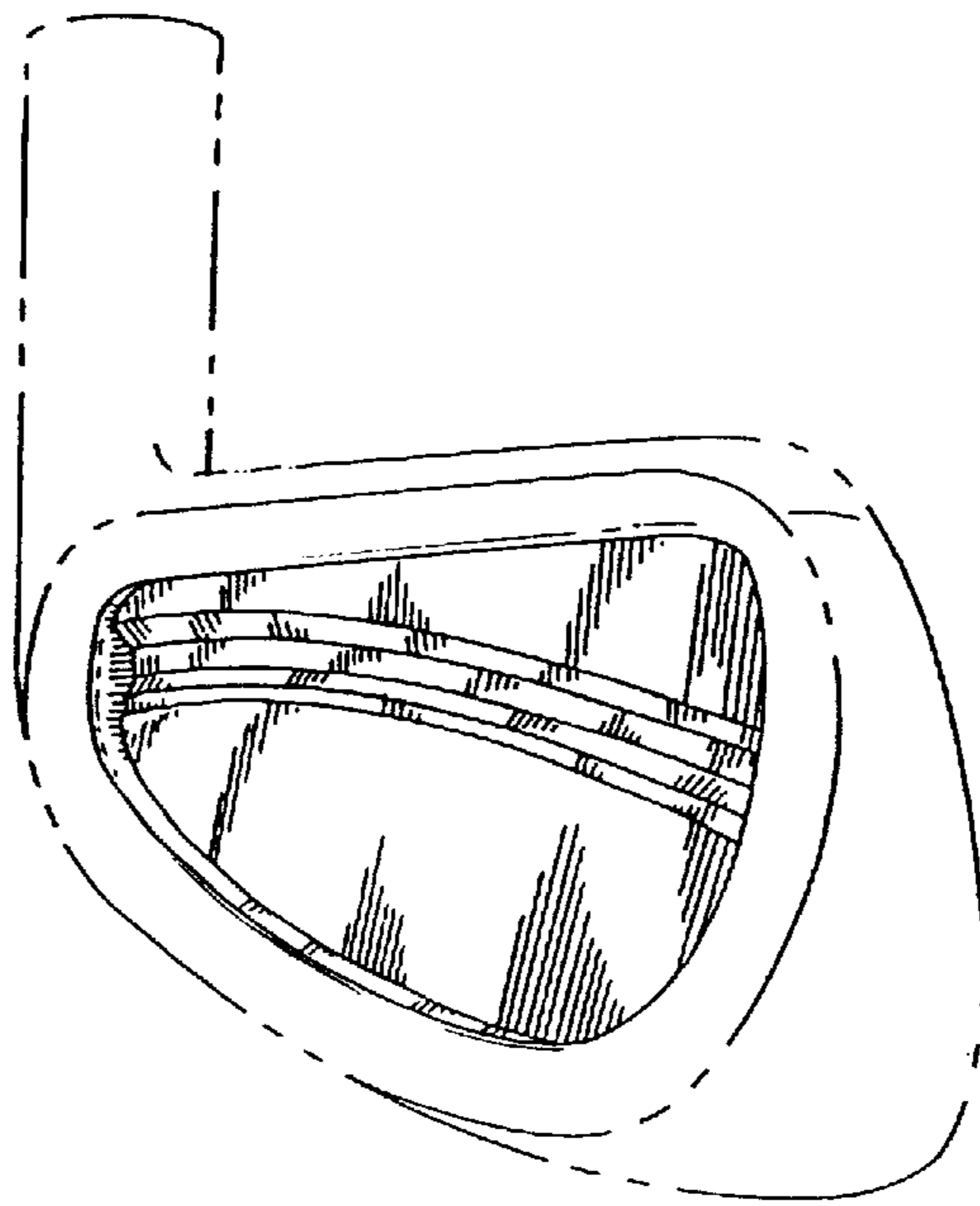

Fig. 2

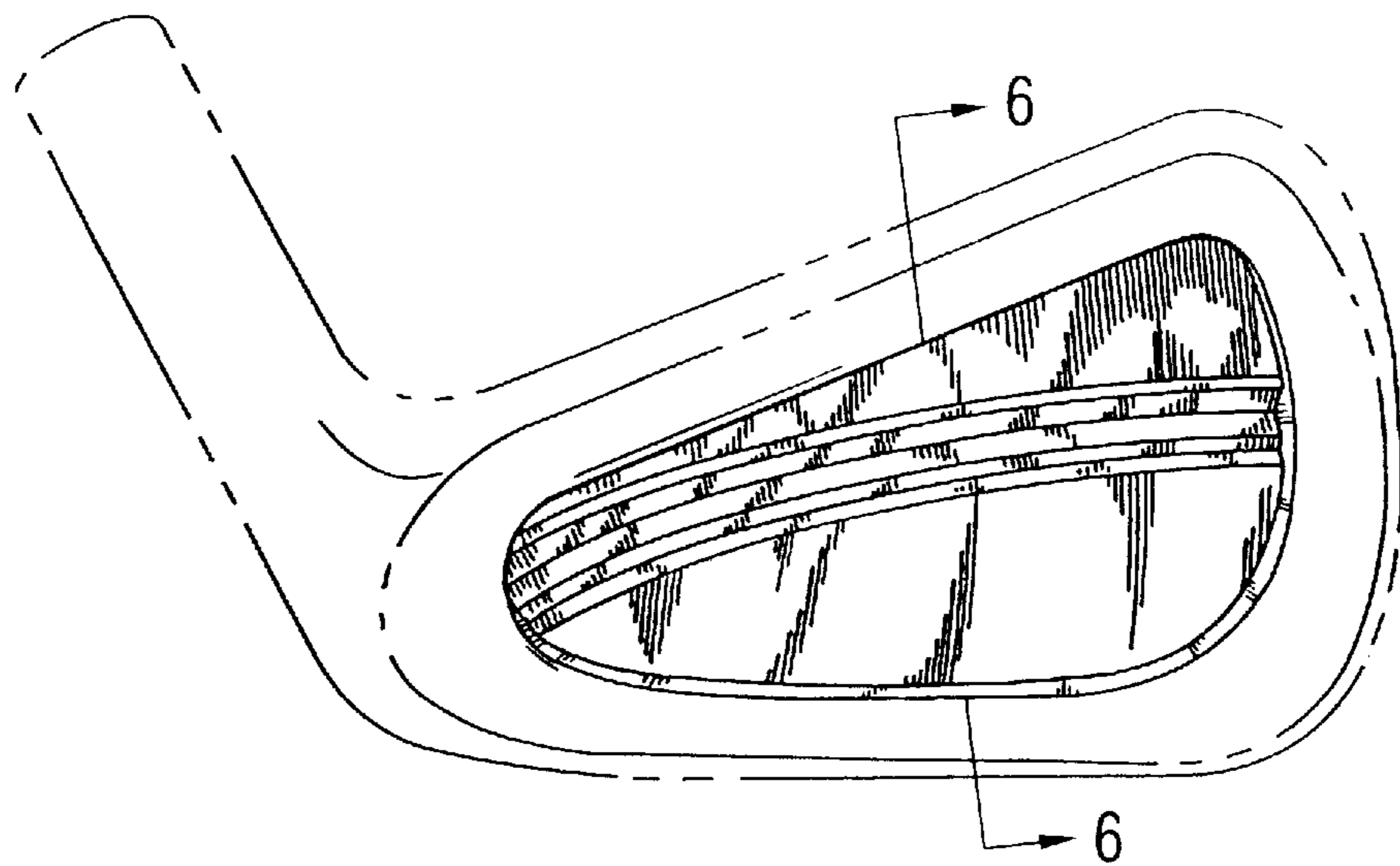

Fig. 3

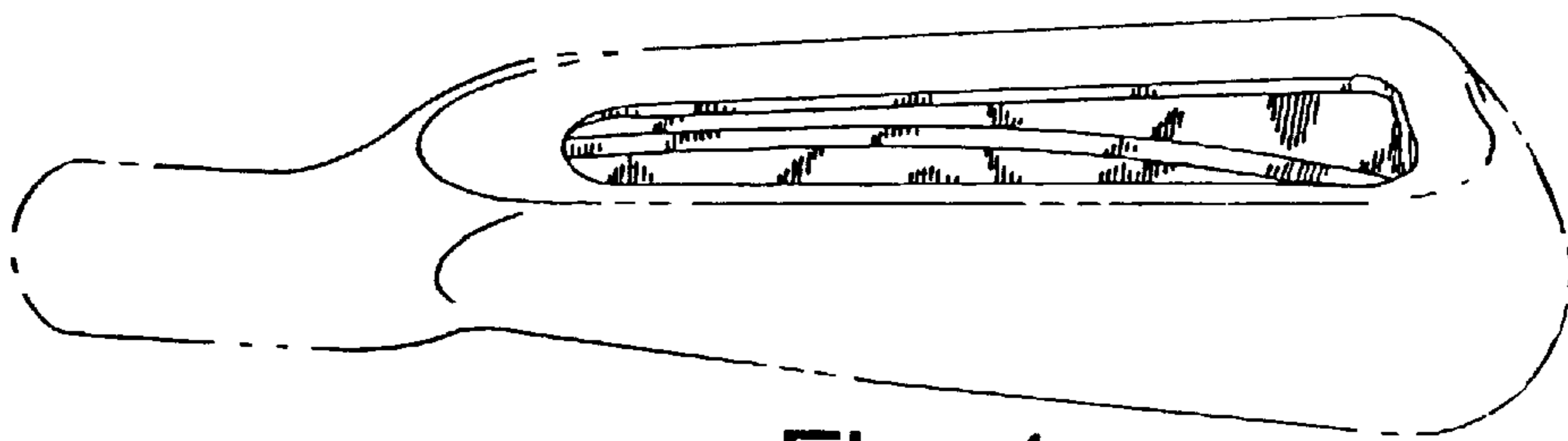

Fig. 4

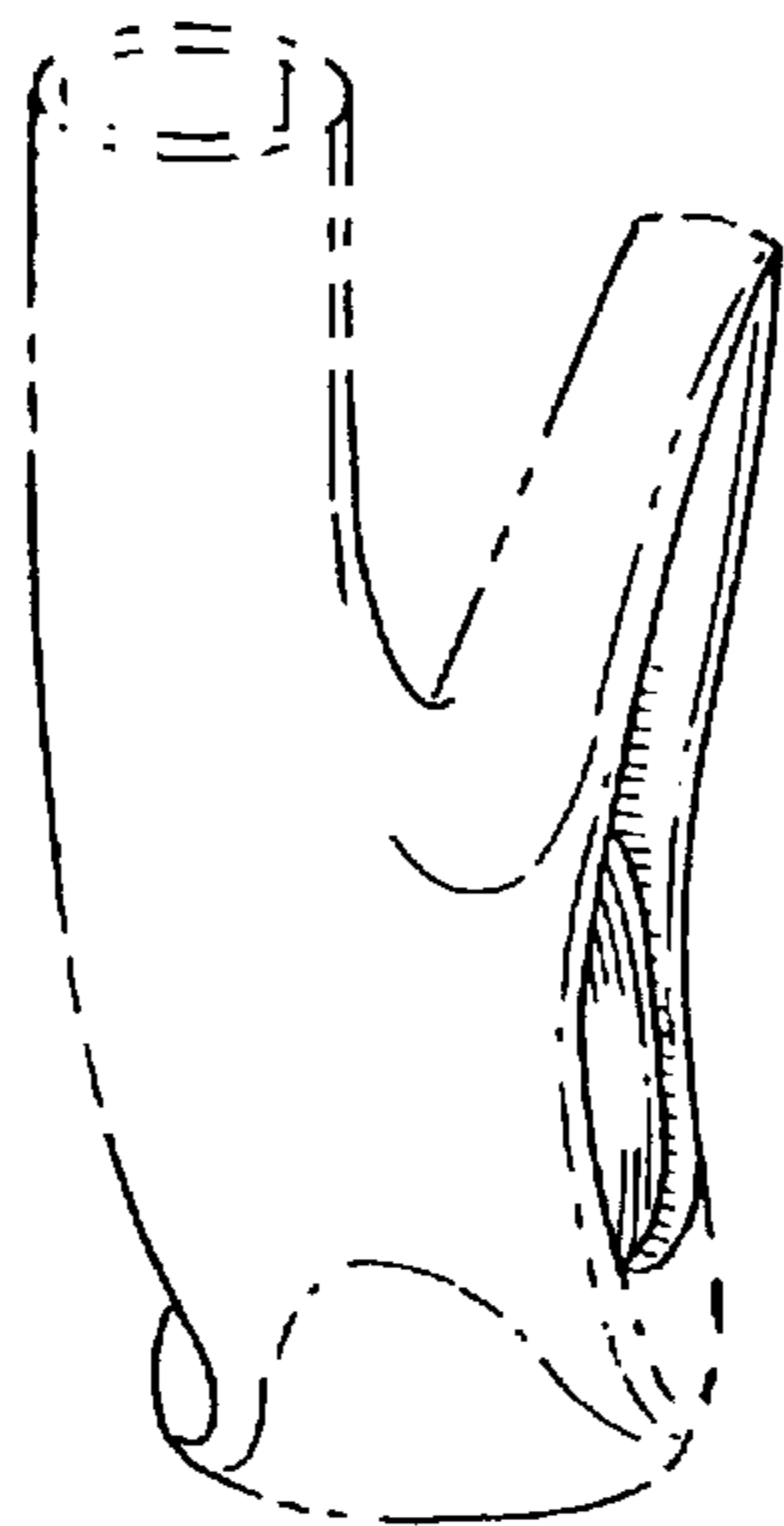

Fig. 5

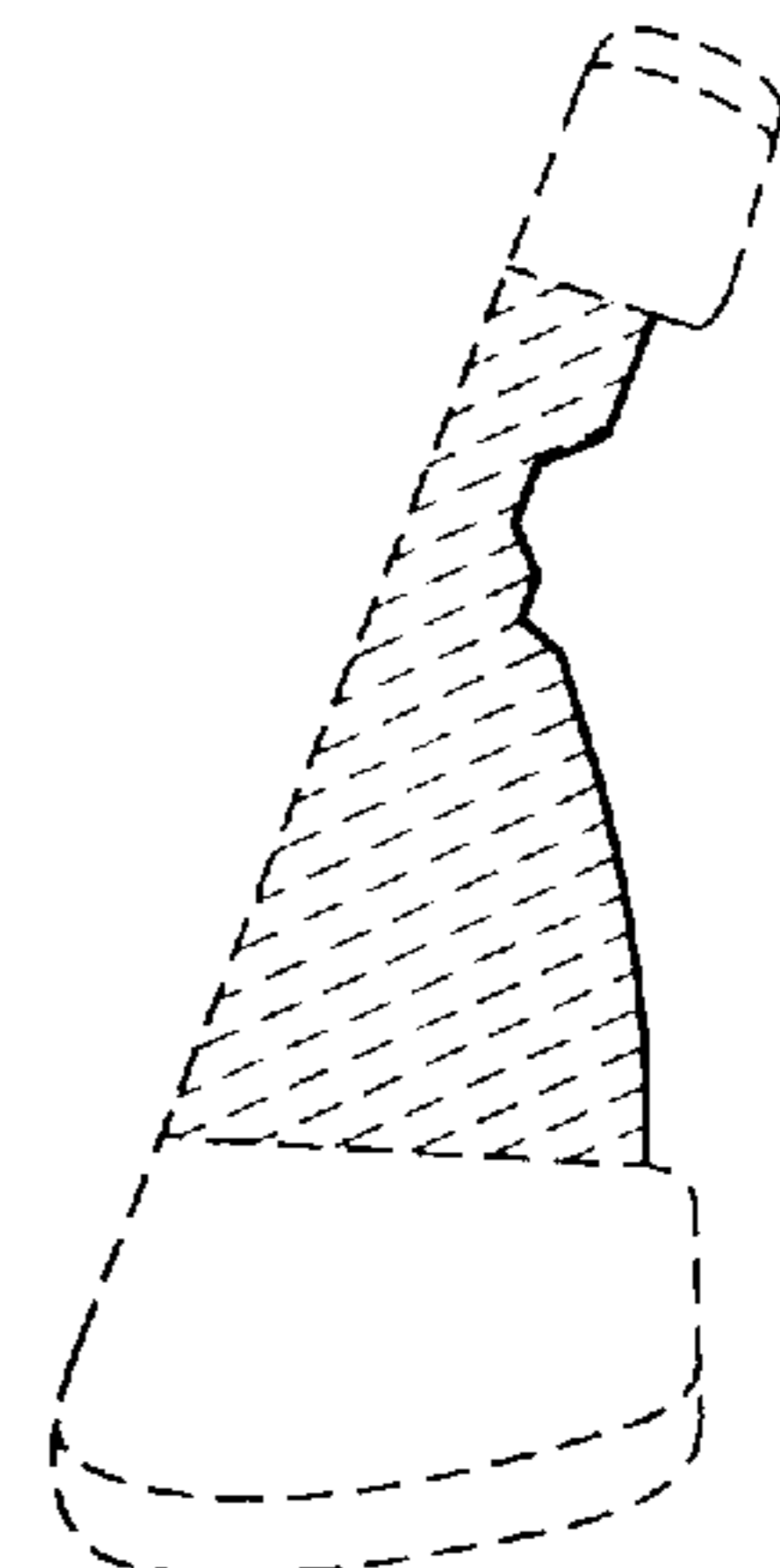

Fig. 6