



US00D432592S

# United States Patent [19] Yip

[11] Patent Number: Des. 432,592

[45] Date of Patent: \*\* Oct. 24, 2000

[54] SET OF PUZZLES AND THEIR PIECES

[76] Inventor: **Chung Lun Yip**, 3rd Floor, Blocks A & C, King Yip Factory Building, No. 59 King Yip Street, Kwun Tong, The Hong Kong Special Administrative Region of the People's Republic of China

[\*\*] Term: **14 Years**

[21] Appl. No.: **29/107,265**

[22] Filed: **Jun. 29, 1999**

[51] LOC (7) Cl. .... **21-01**

[52] U.S. Cl. .... **D21/480**

[58] Field of Search ..... D21/478, 480;  
273/153 R, 157 R

[56] **References Cited**

**U.S. PATENT DOCUMENTS**

D. 262,389	12/1981	Bogue	.....	D21/480
D. 265,919	8/1982	Spiecker	.....	D21/480
D. 275,301	8/1984	Cloud	.....	D21/480
1,271,997	7/1918	Benedict	.....	273/157 R
1,565,099	12/1925	Nierodka	.....	273/157 R
1,630,530	5/1927	Fryer	.....	273/157 R
2,901,256	8/1959	Way	.....	273/157 R
4,531,741	7/1985	Eskina	.....	273/157 R

*Primary Examiner*—Dominic Simone  
*Attorney, Agent, or Firm*—Ladas & Parry

[57] **CLAIM**

I claim the ornamental design for set of puzzles and their pieces, as shown.

**DESCRIPTION**

FIG. 1 is a front elevational view of a set of puzzles and their pieces showing my new design;  
FIG. 2 is a rear elevational view thereof;  
FIG. 3 is a left-side elevational view thereof;  
FIG. 4 is a right-side elevational view thereof;  
FIG. 5 is a top plan view thereof;  
FIG. 6 is a bottom plan view thereof;

FIG. 7 is a front/top/right-side perspective view thereof;  
FIG. 8 is a front elevational view of a second piece of the puzzles;  
FIG. 9 is a rear elevational view thereof;  
FIG. 10 is a left-side elevational view thereof;  
FIG. 11 is a right-side elevational view thereof;  
FIG. 12 is a top plan view thereof;  
FIG. 13 is a bottom plan view thereof;  
FIG. 14 is a front/top/right-side perspective view thereof;  
FIG. 15 is a front elevational view of a third piece of the puzzles;  
FIG. 16 is a rear elevational view thereof;  
FIG. 17 is a left-side elevational view thereof;  
FIG. 18 is a right-side elevational view thereof;  
FIG. 19 is a top plan view thereof;  
FIG. 20 is a bottom plan view thereof;  
FIG. 21 is a front/top/left-side elevational view thereof;  
FIG. 22 is a front elevational view of a third piece of the puzzles;  
FIG. 23 is a rear elevational view thereof;  
FIG. 24 is a left-side elevational view thereof;  
FIG. 25 is a right-side elevational view thereof;  
FIG. 26 is a top plan view thereof;  
FIG. 27 is a bottom plan view thereof;  
FIG. 28 is a front/top/right-side perspective view thereof;  
FIG. 29 is a front/bottom/right-side perspective view of the pieces in a first of the puzzles;  
FIG. 30 is a front/bottom/right-side perspective view of the pieces in a second of the puzzles;  
FIG. 31 is a front/right-side perspective view of the pieces in a third of the puzzles;  
FIG. 32 is a front/bottom/right-side perspective view of the pieces in a fourth of the puzzles;  
FIG. 33 is a front/top/left-side perspective view of the pieces in a fifth of the puzzles;  
FIG. 34 is a front elevational view thereof;  
FIG. 35 is a rear elevational view thereof;  
FIG. 36 is a left-side elevational view thereof;  
FIG. 37 is a right-side elevational view thereof;  
FIG. 38 is a top plan view thereof; and,  
FIG. 39 is a bottom plan view thereof.

**1 Claim, 17 Drawing Sheets**

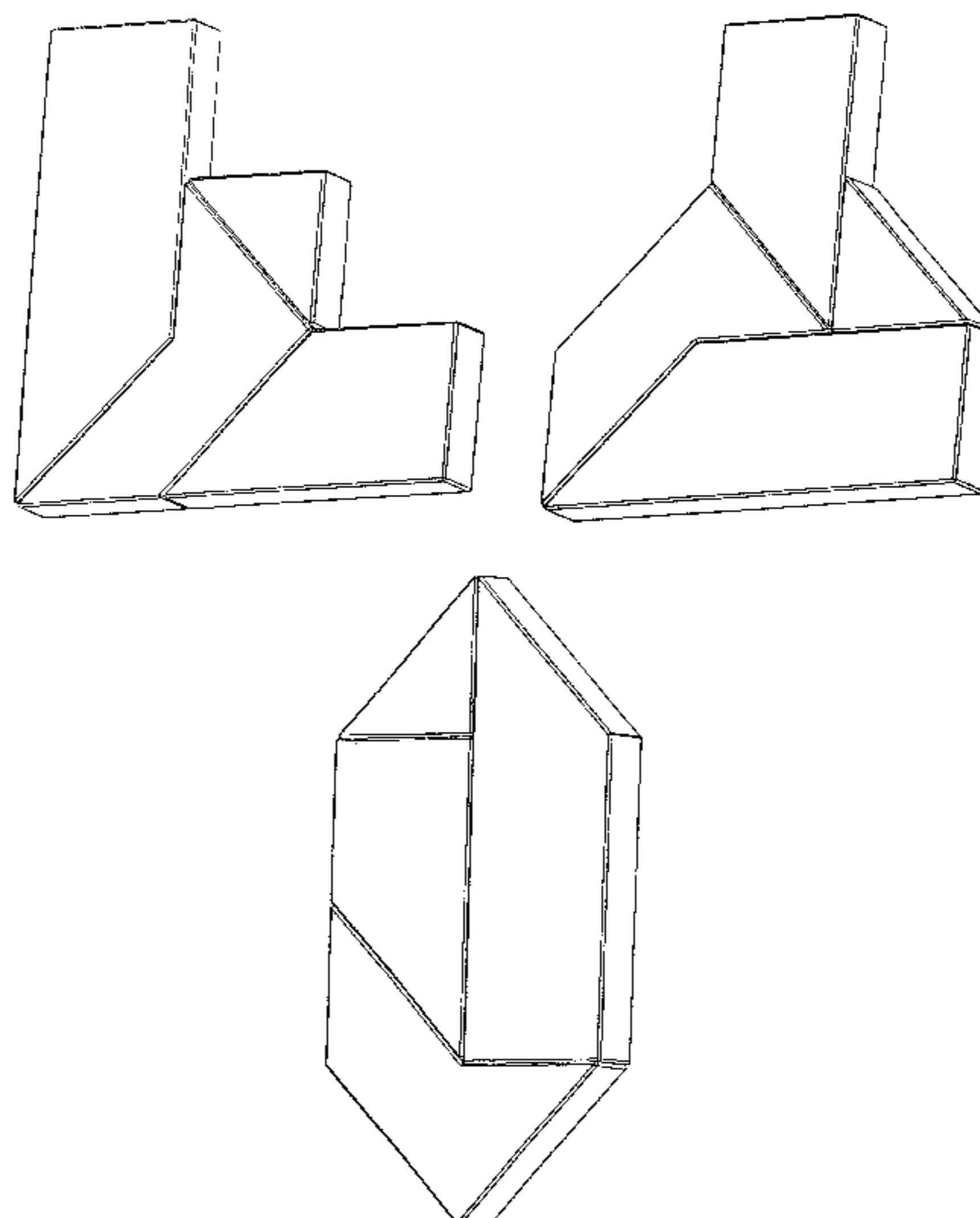

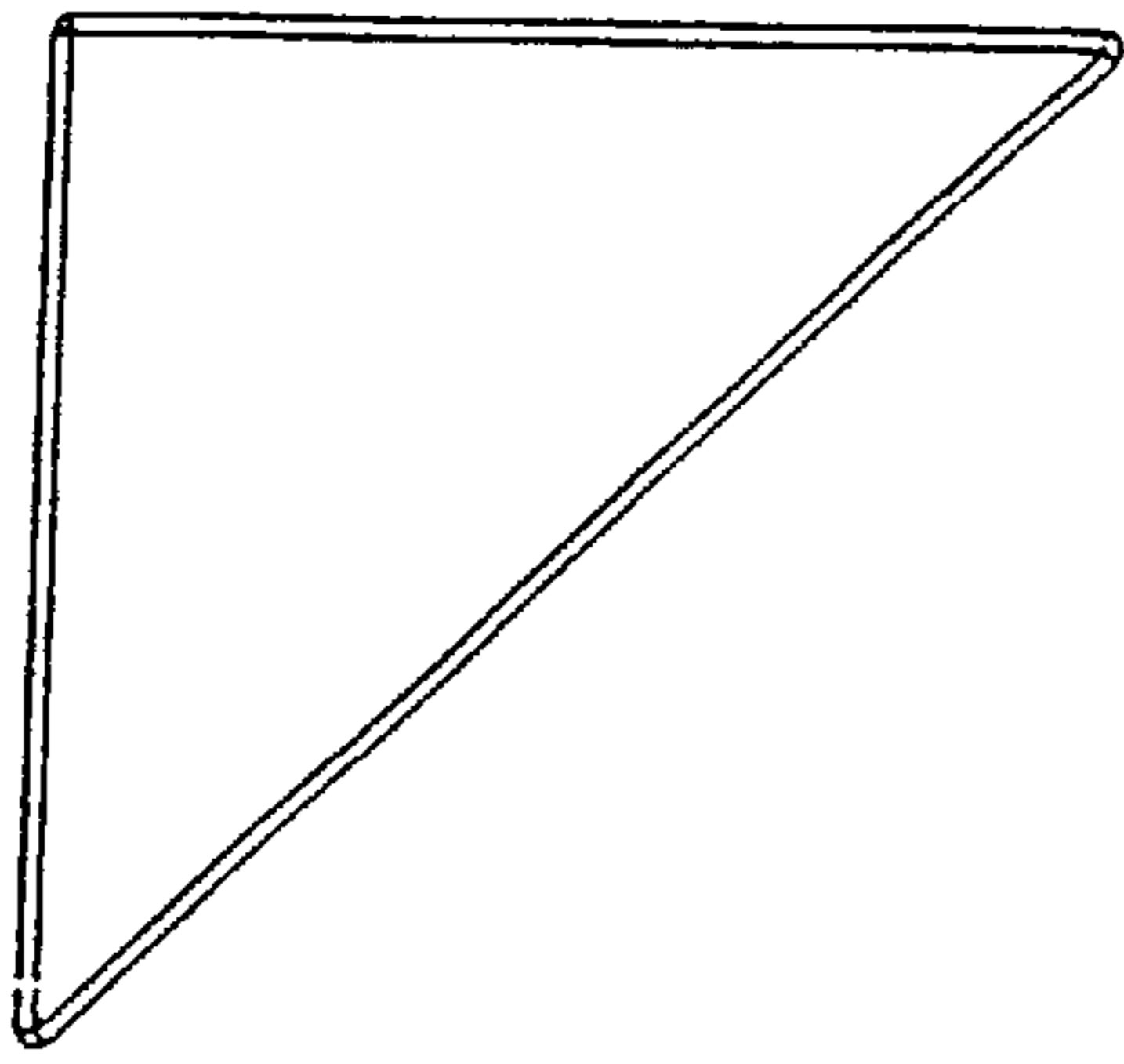

FIG. 1

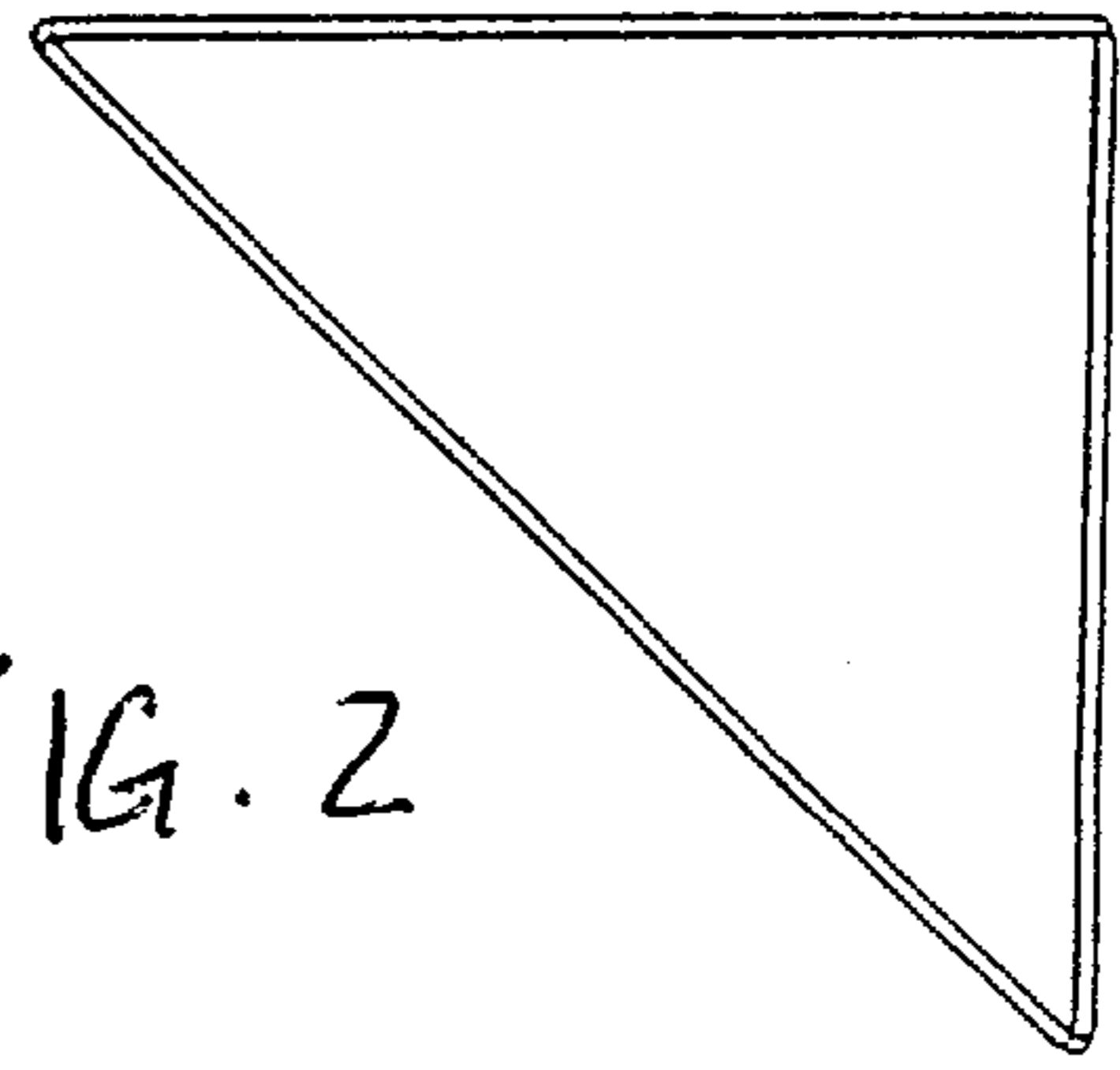

FIG. 2

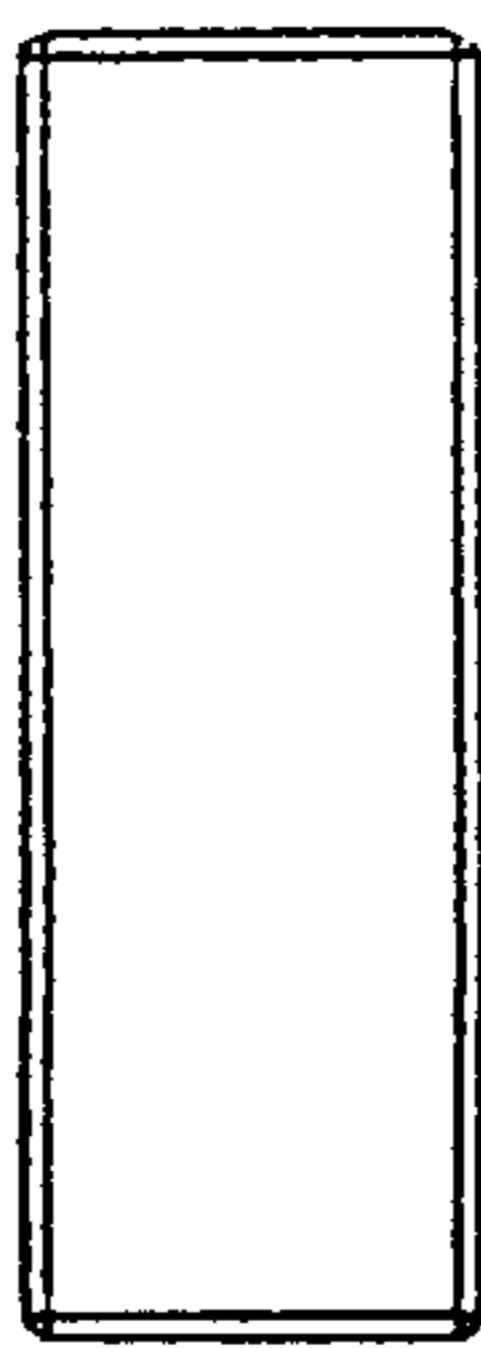

FIG. 3

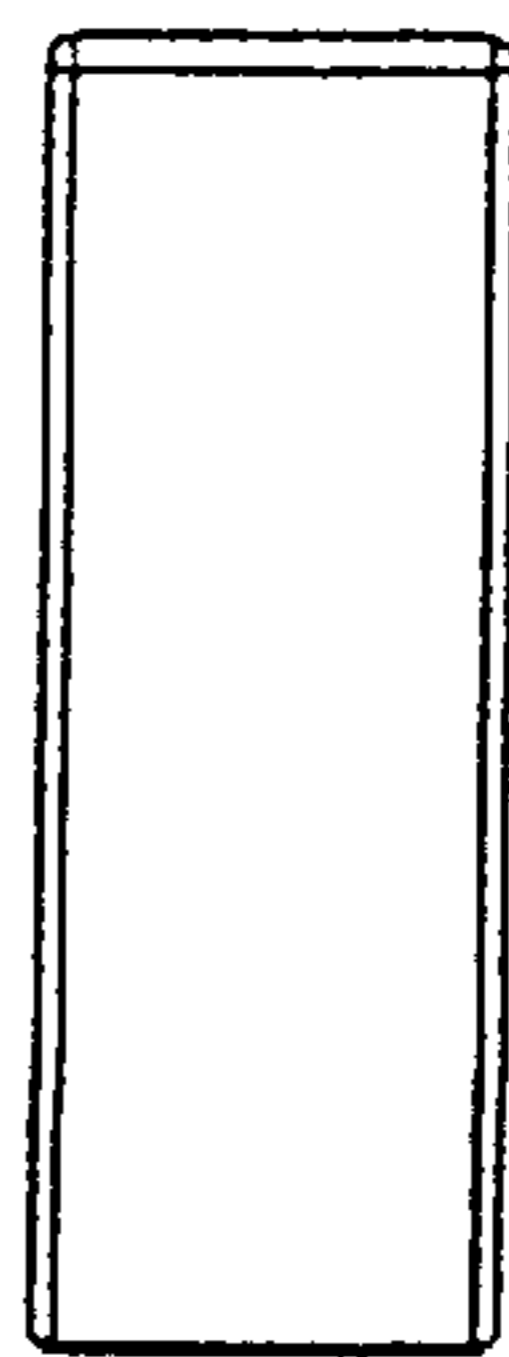

FIG. 4



FIG. 5



FIG. 6

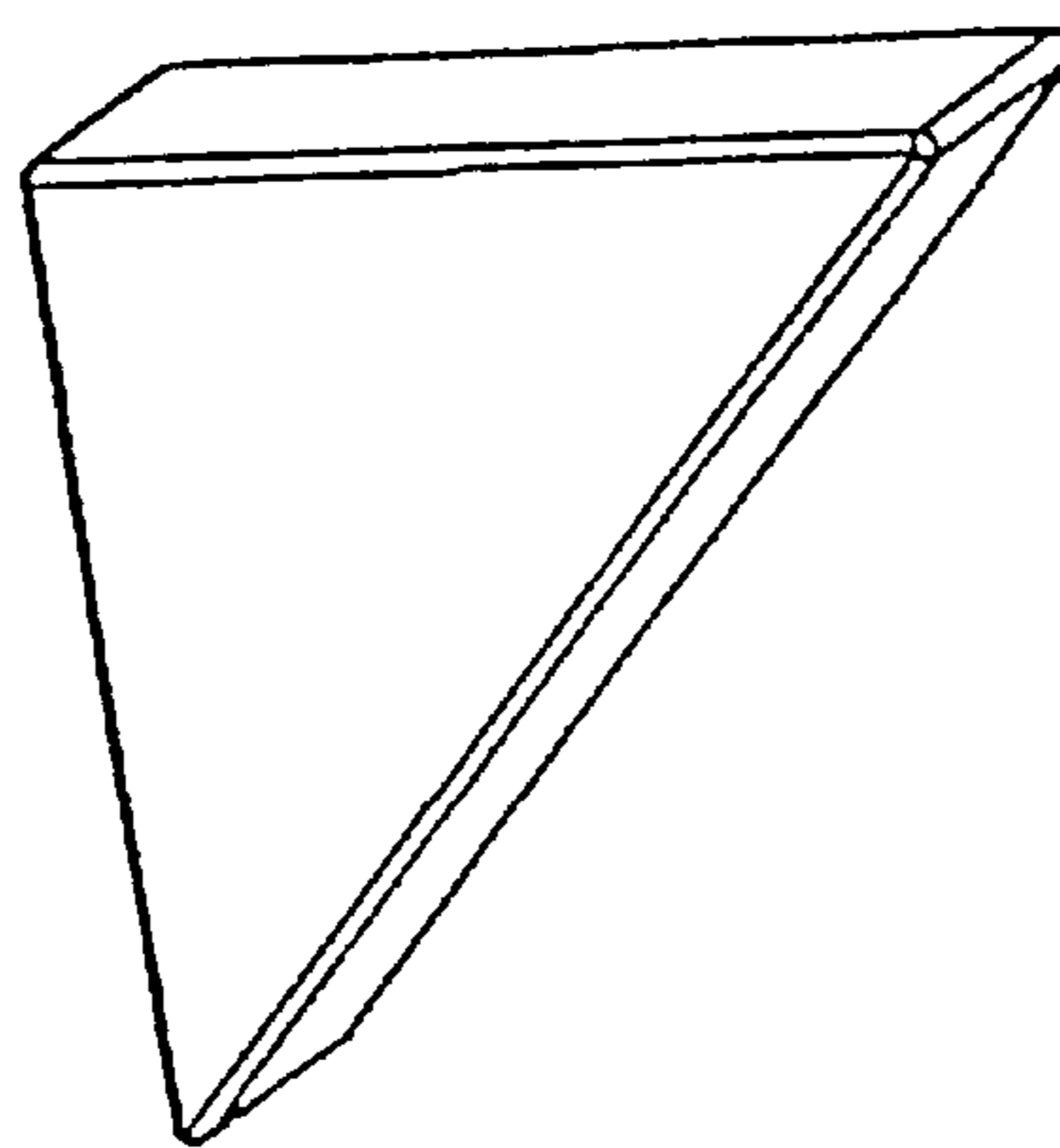

FIG. 7

FIG. 8

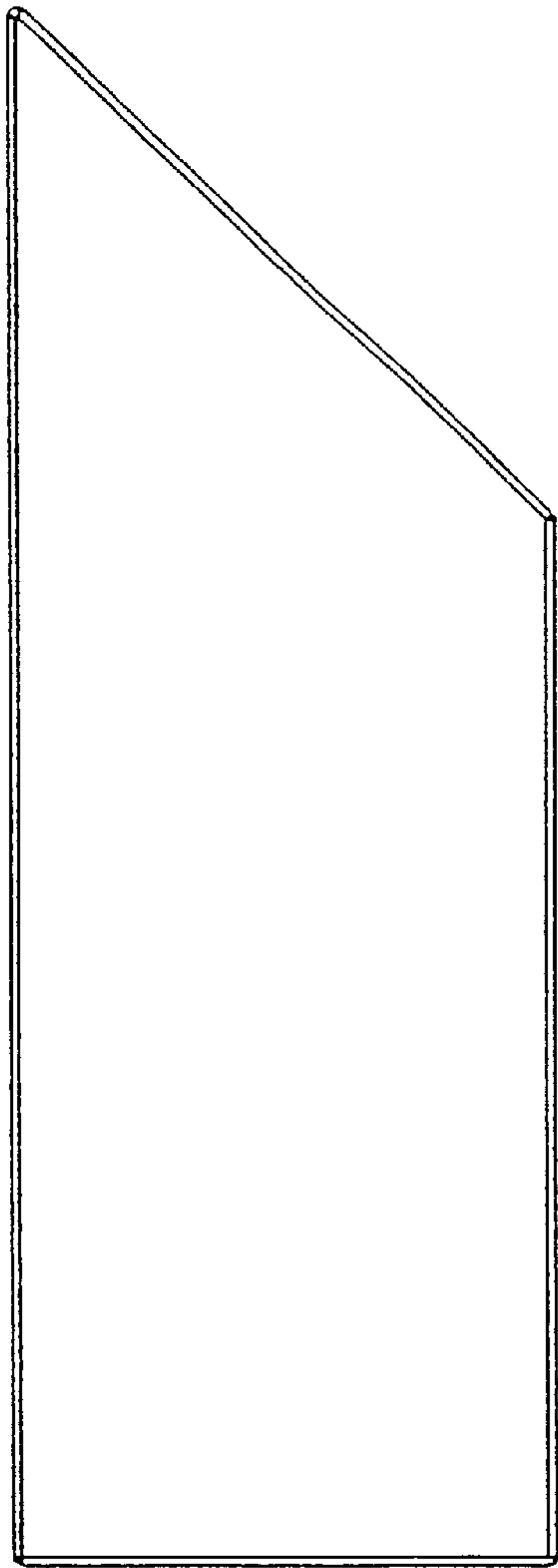

FIG. 9

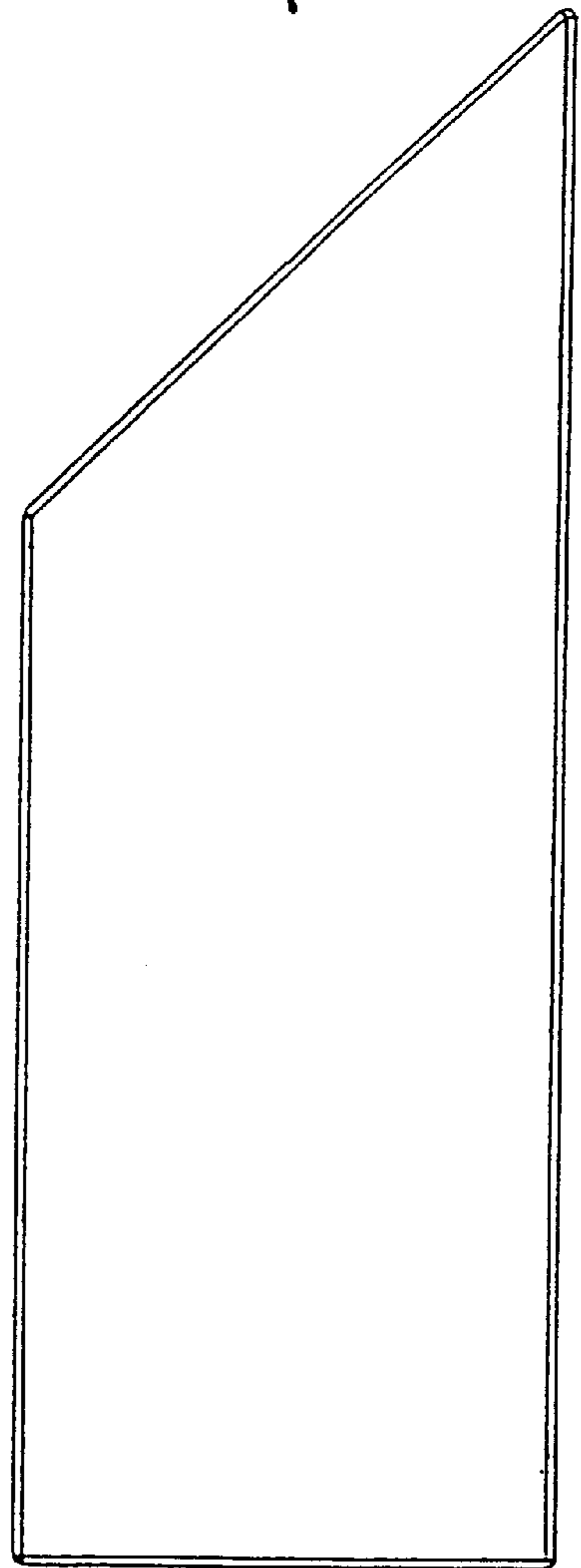

FIG. 10

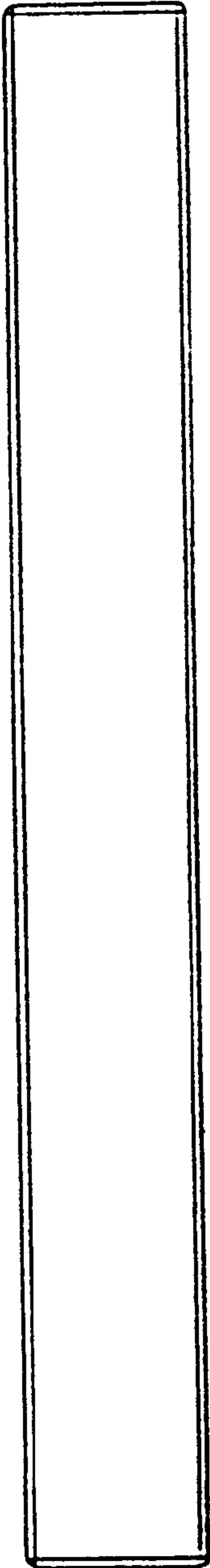

FIG. 11

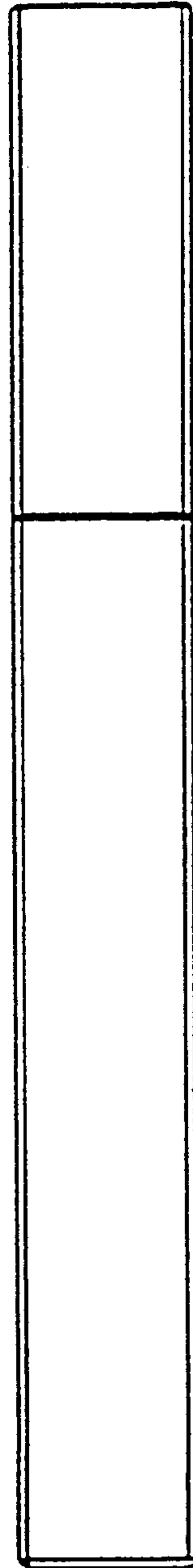

FIG. 12

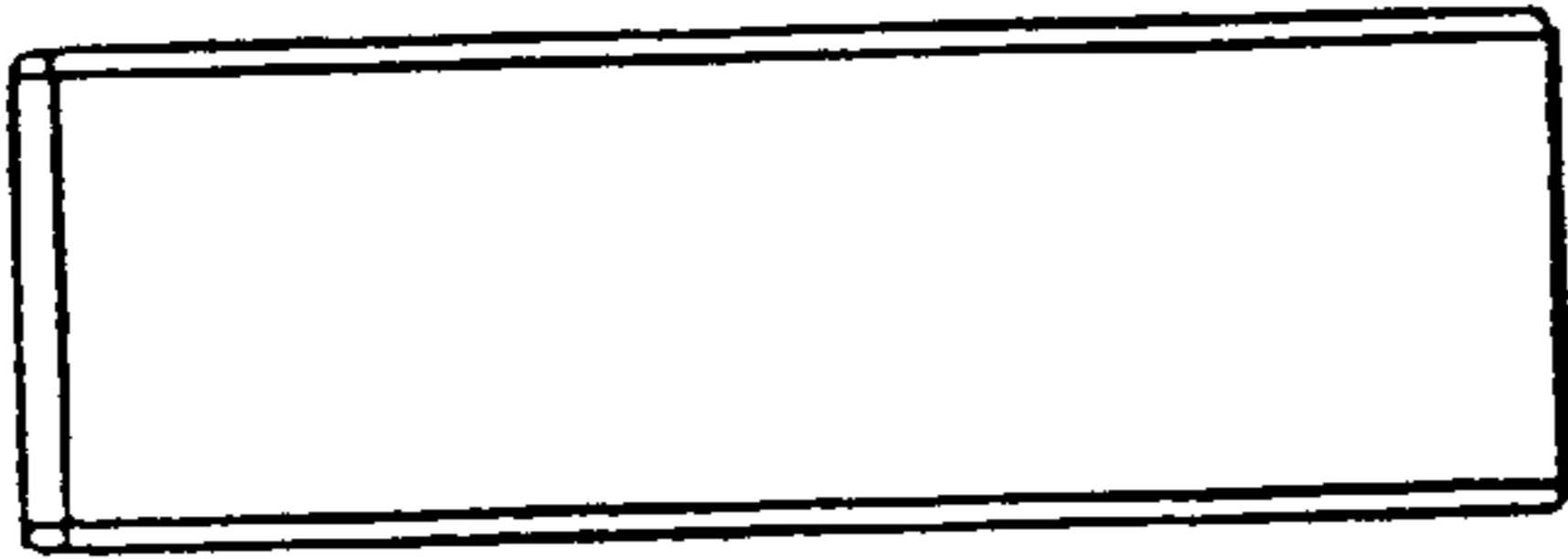

FIG. 13

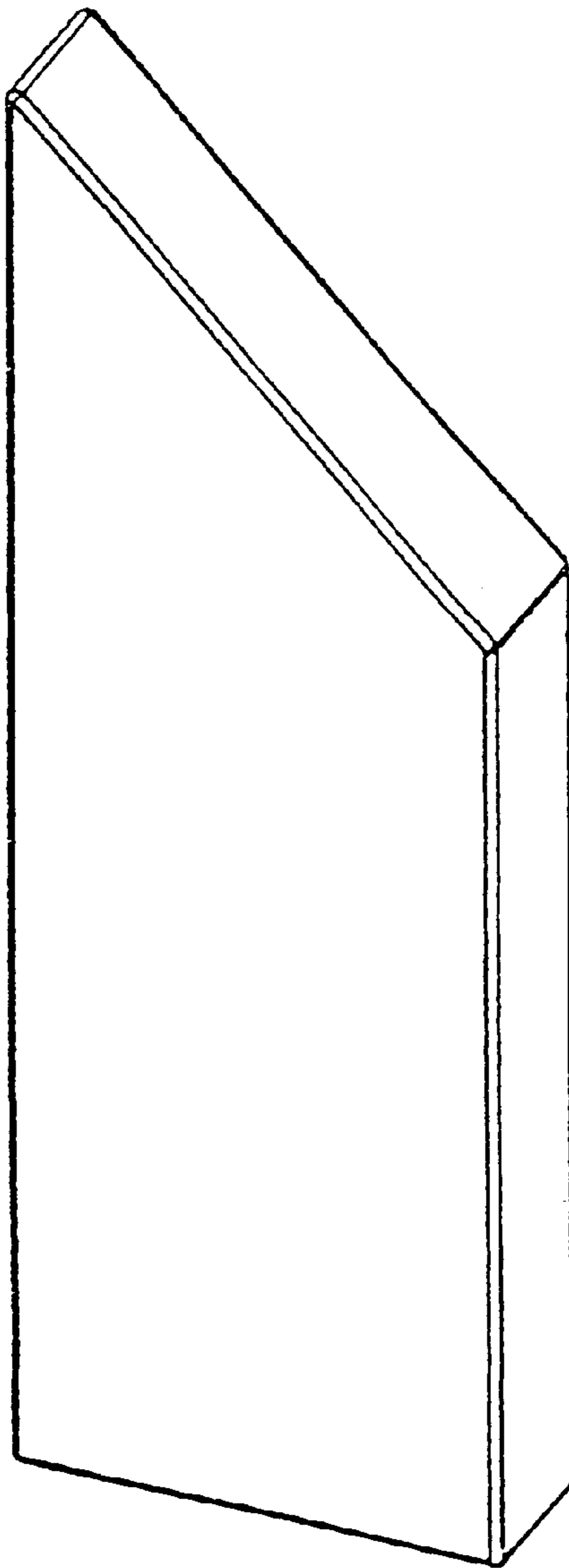

FIG. 14

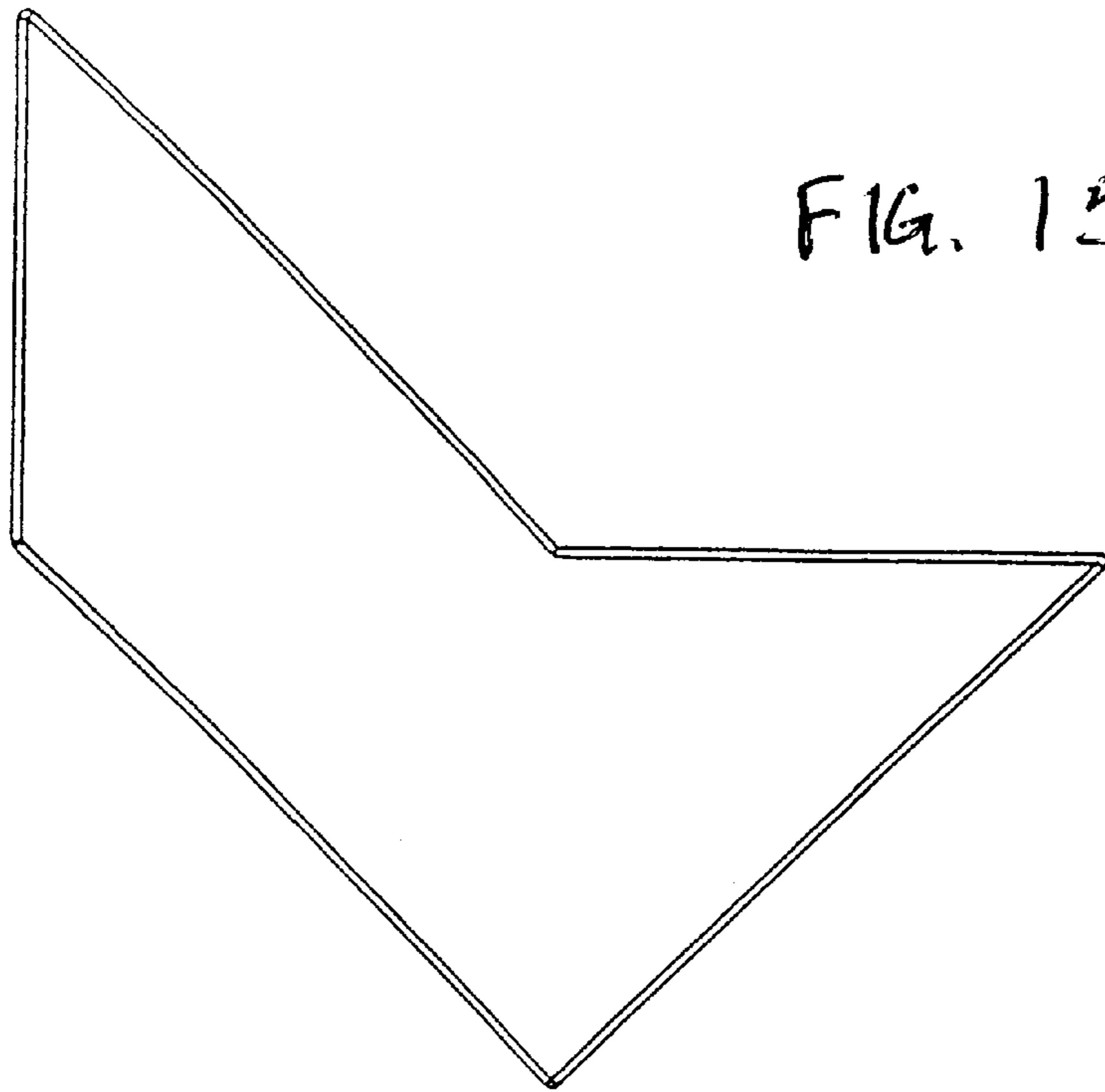

FIG. 15

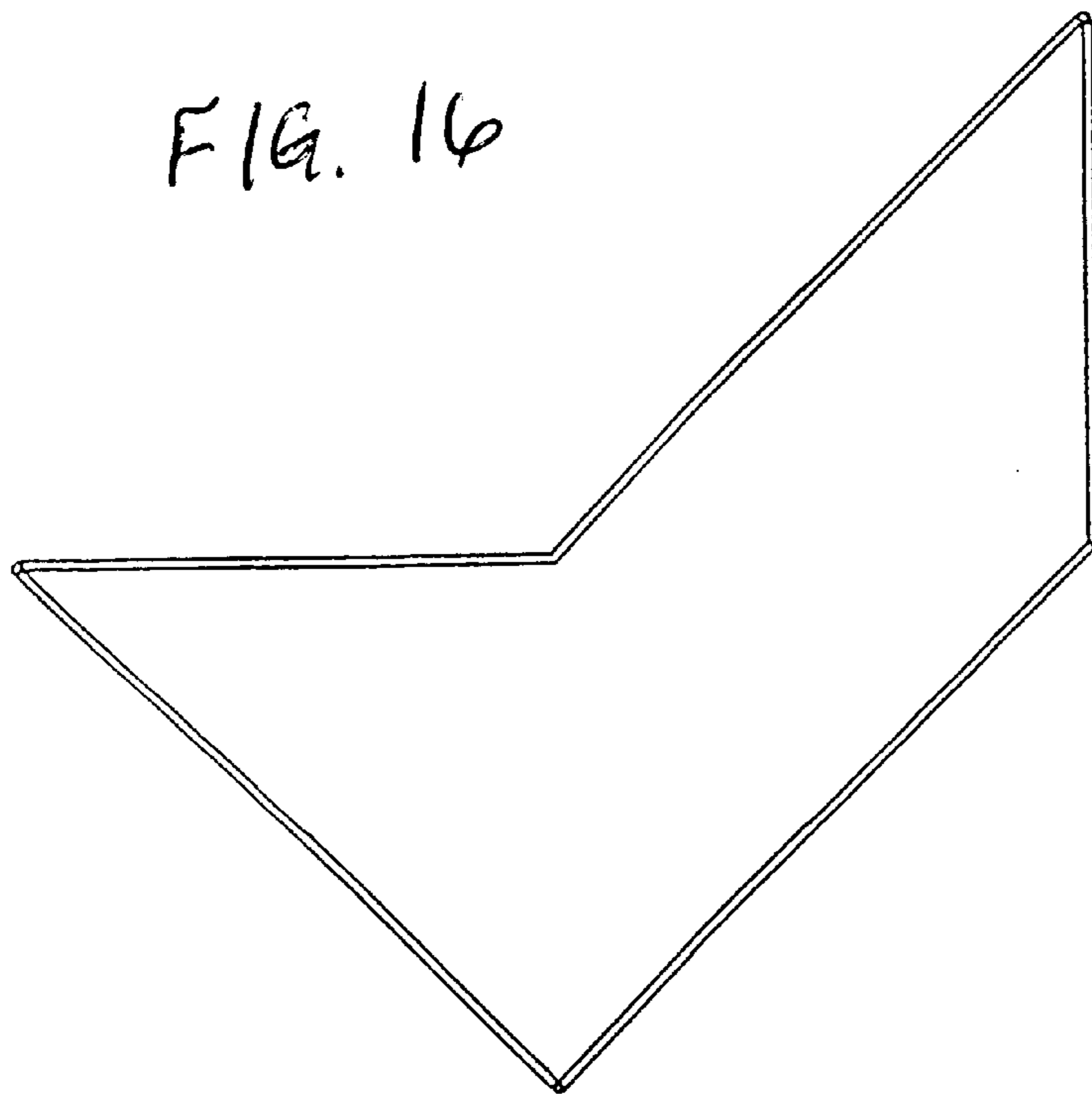

FIG. 16

FIG. 17

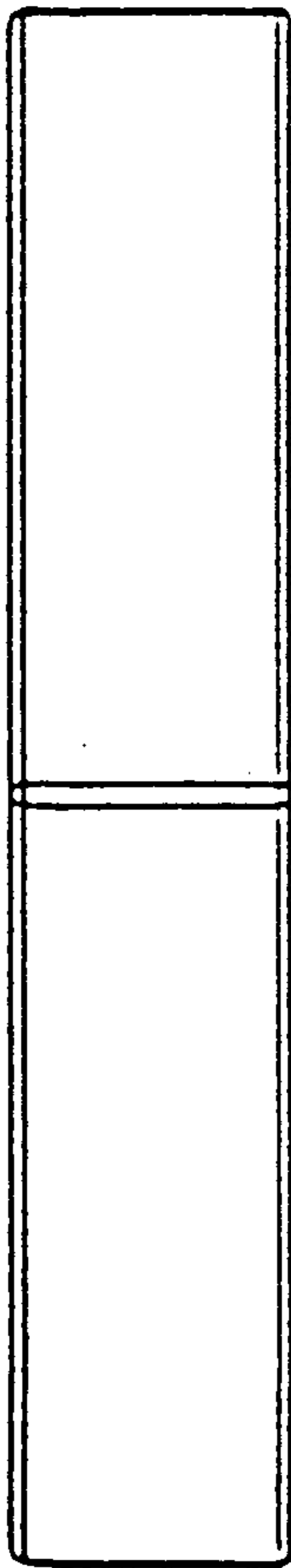
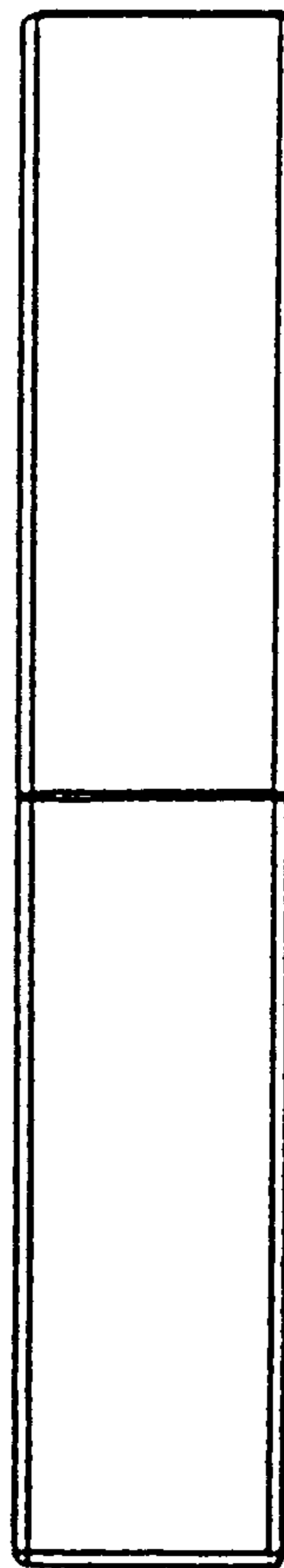

FIG. 18





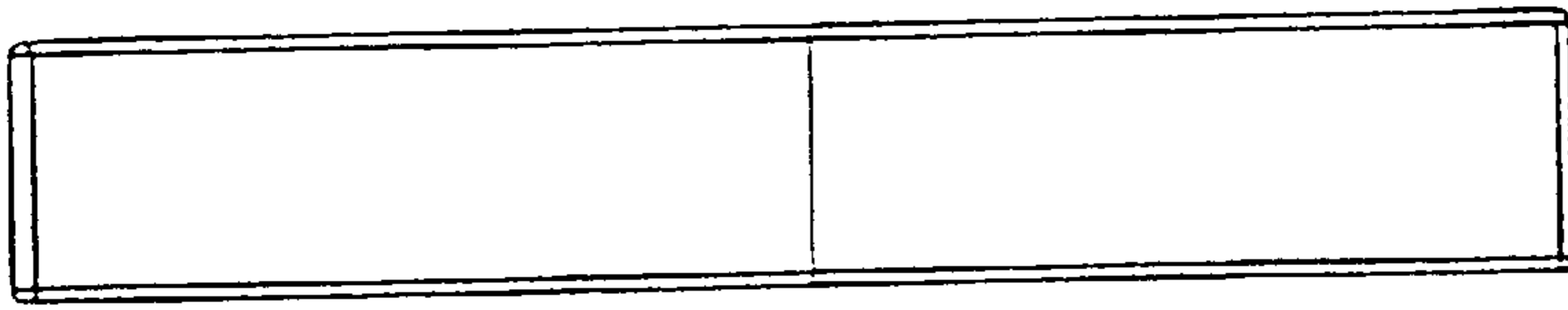

FIG. 19

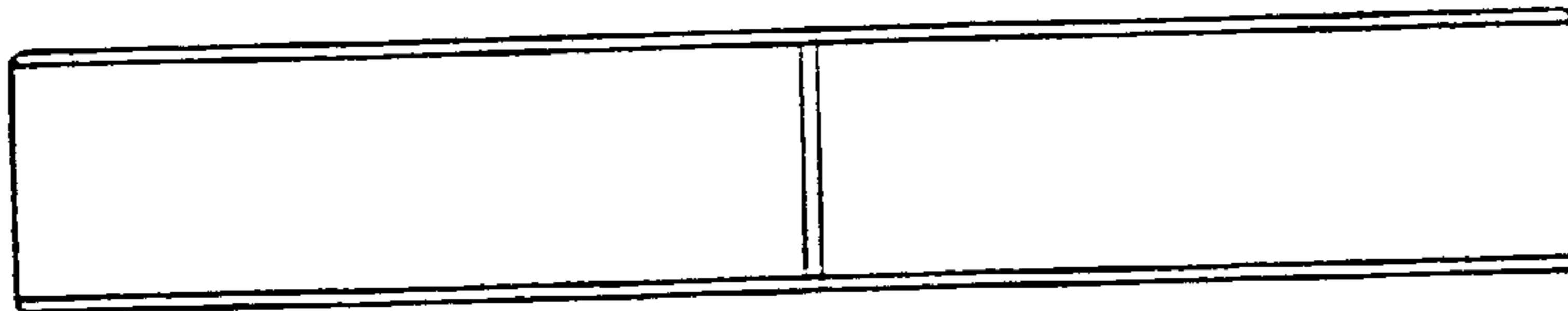

FIG. 20

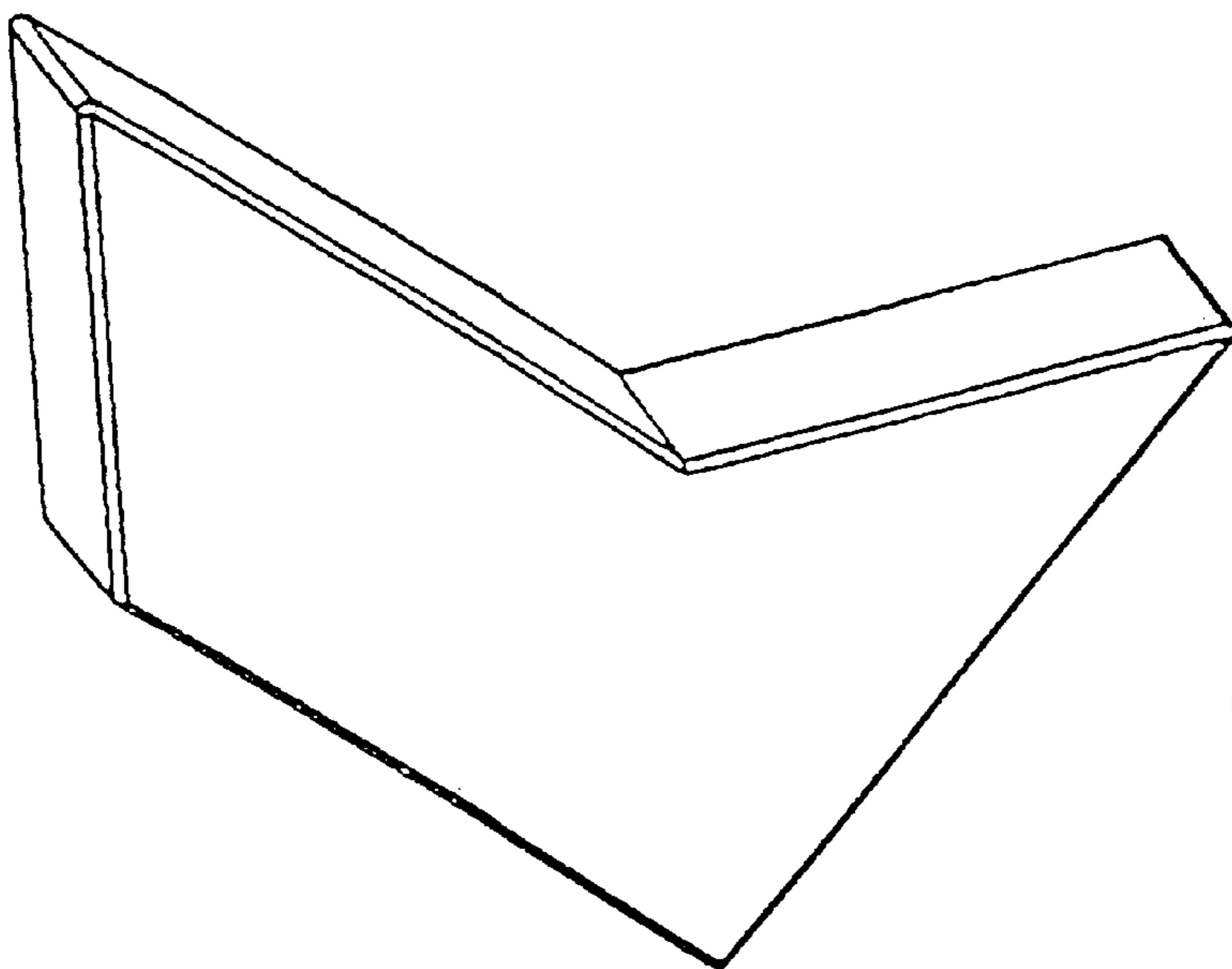

FIG. 21

FIG. 22

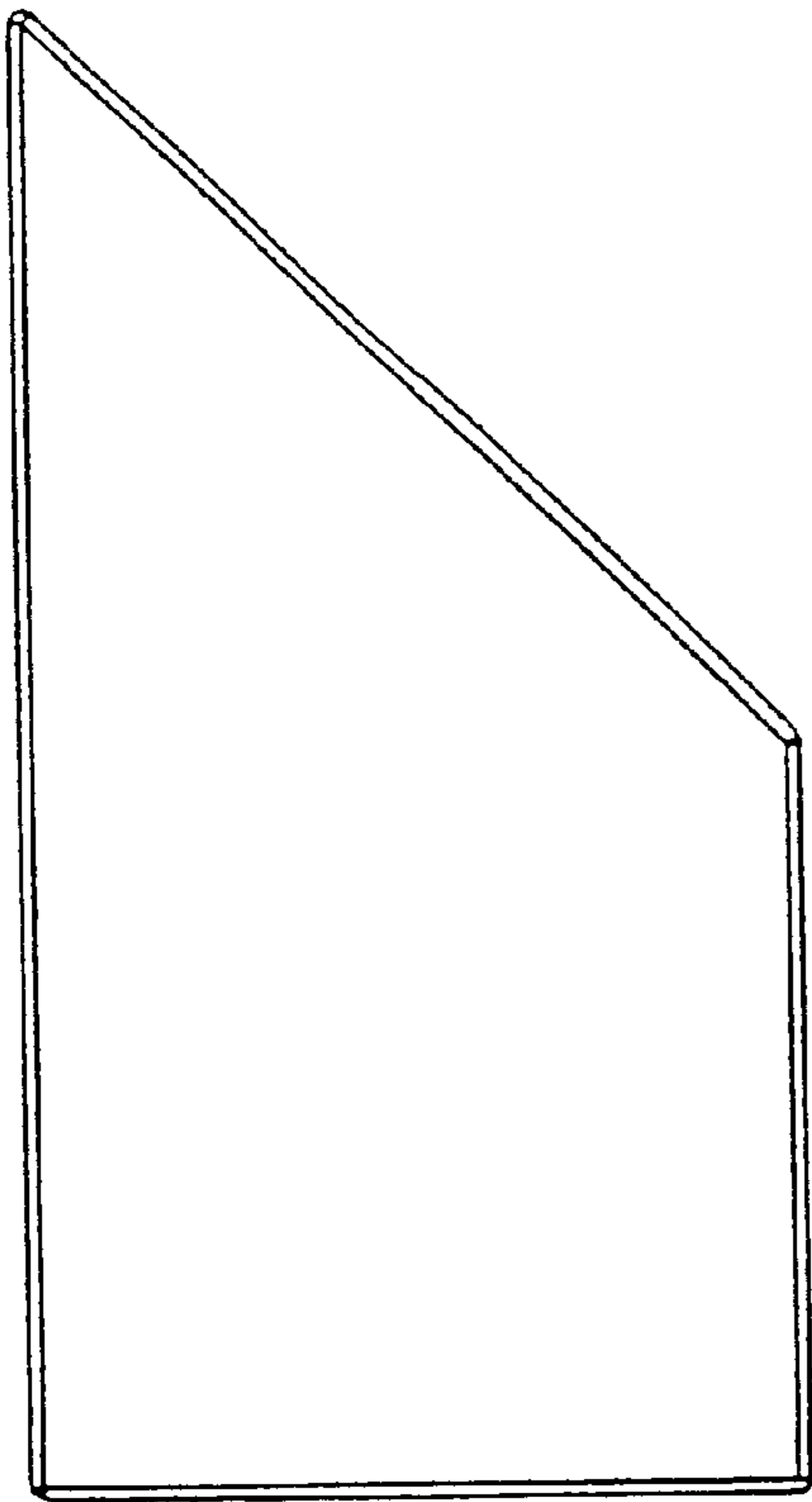

FIG. 23

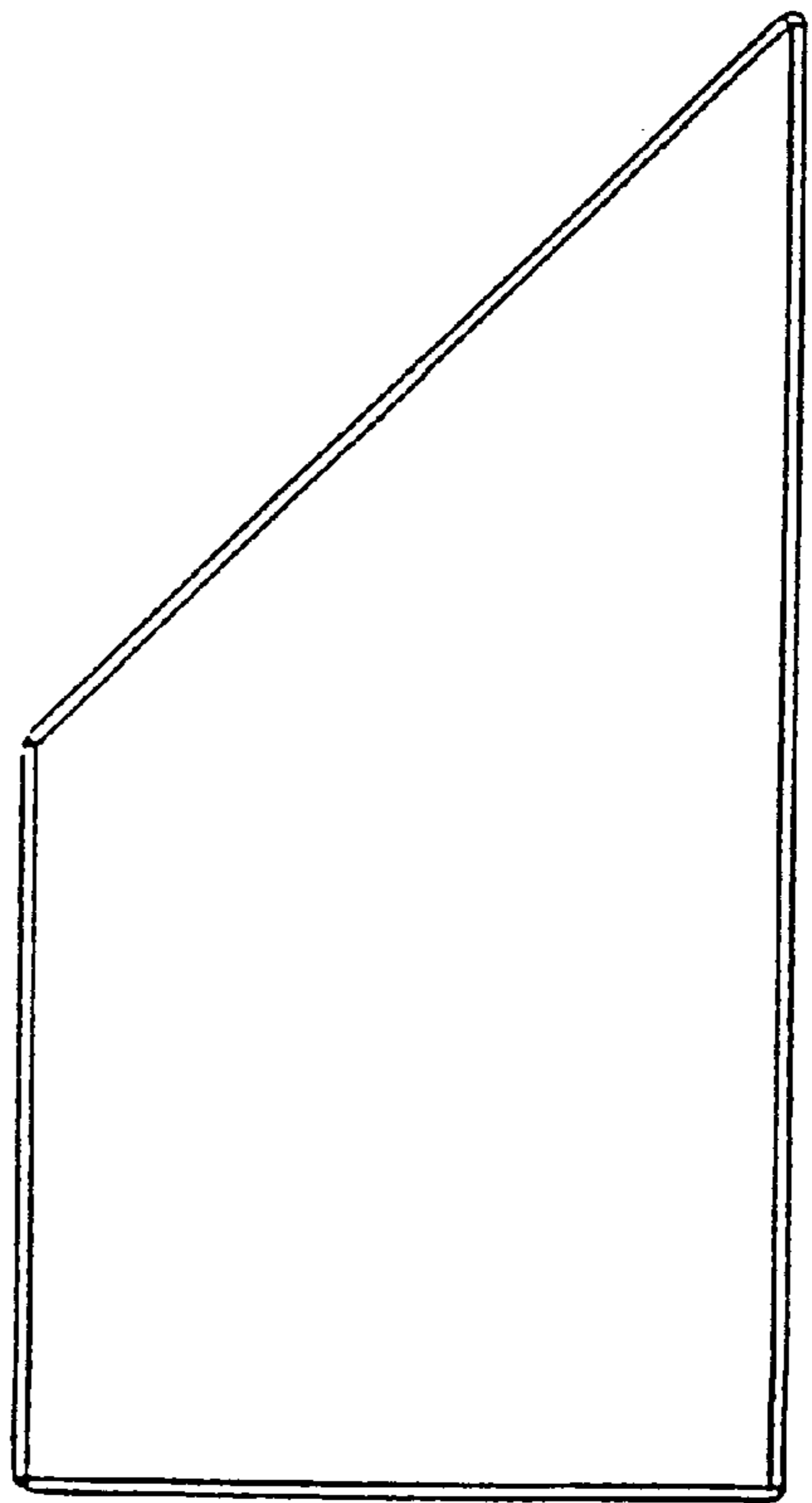

FIG. 24

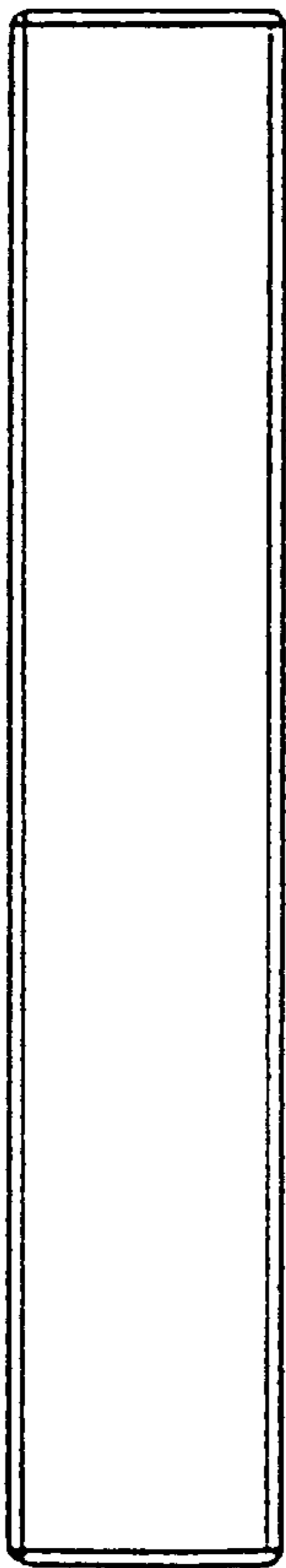
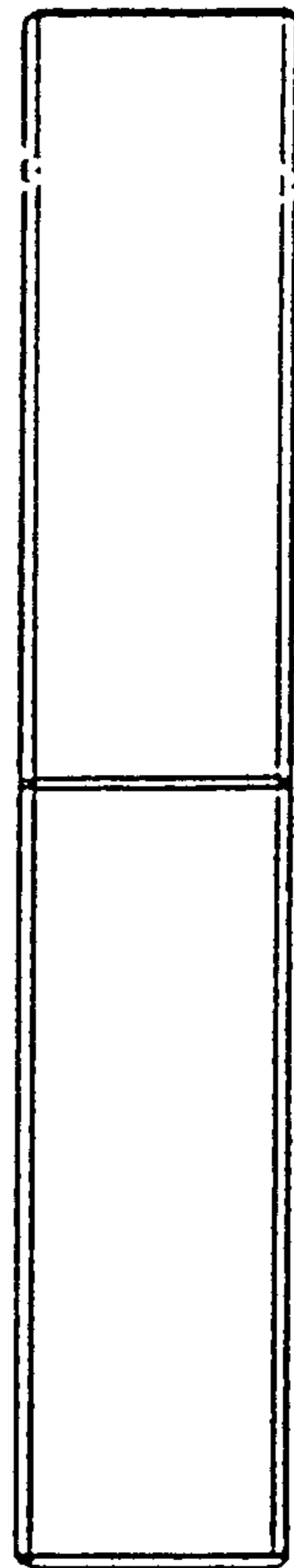

FIG. 25



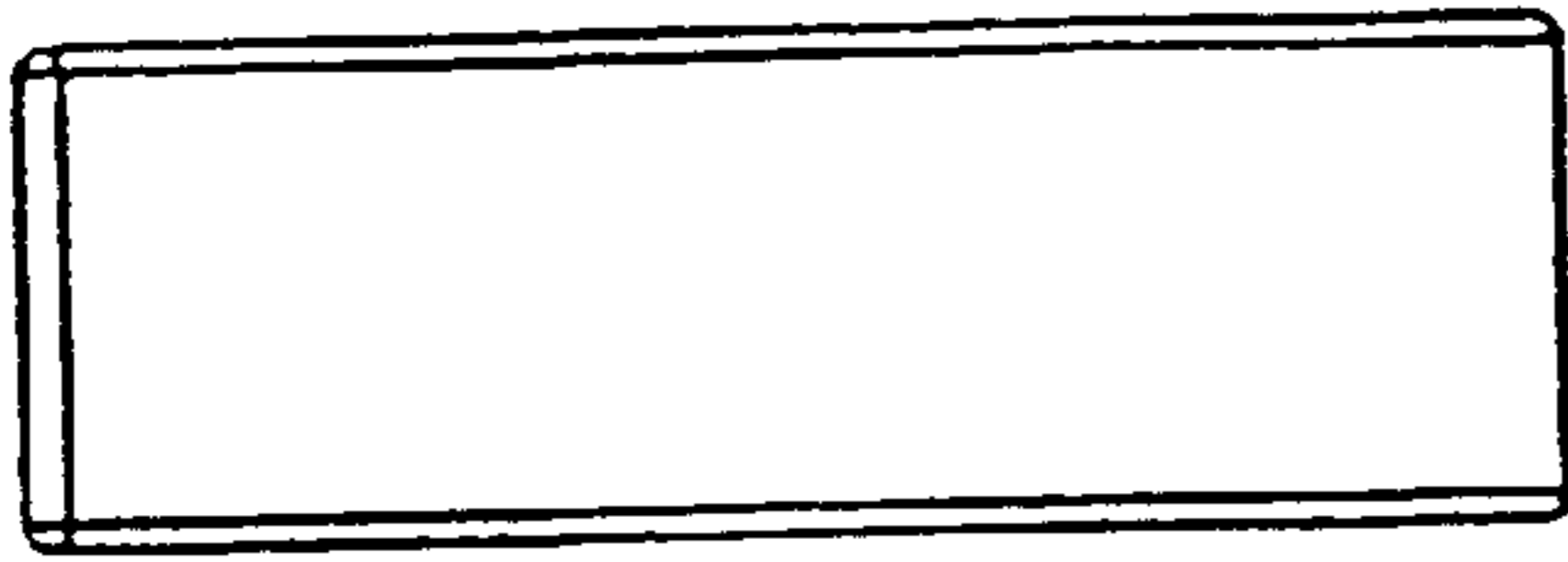

FIG. 26



FIG. 27

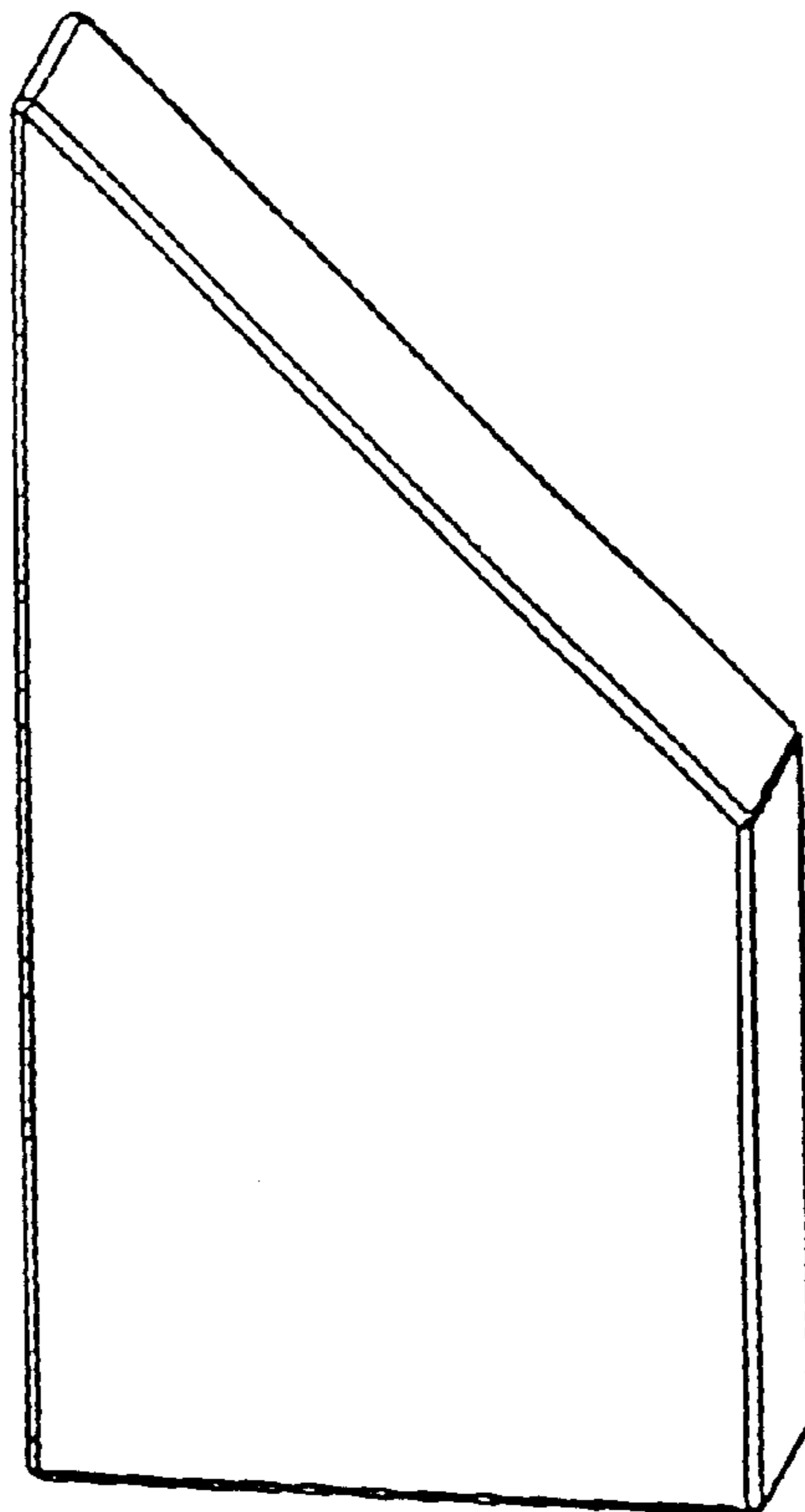

FIG. 28

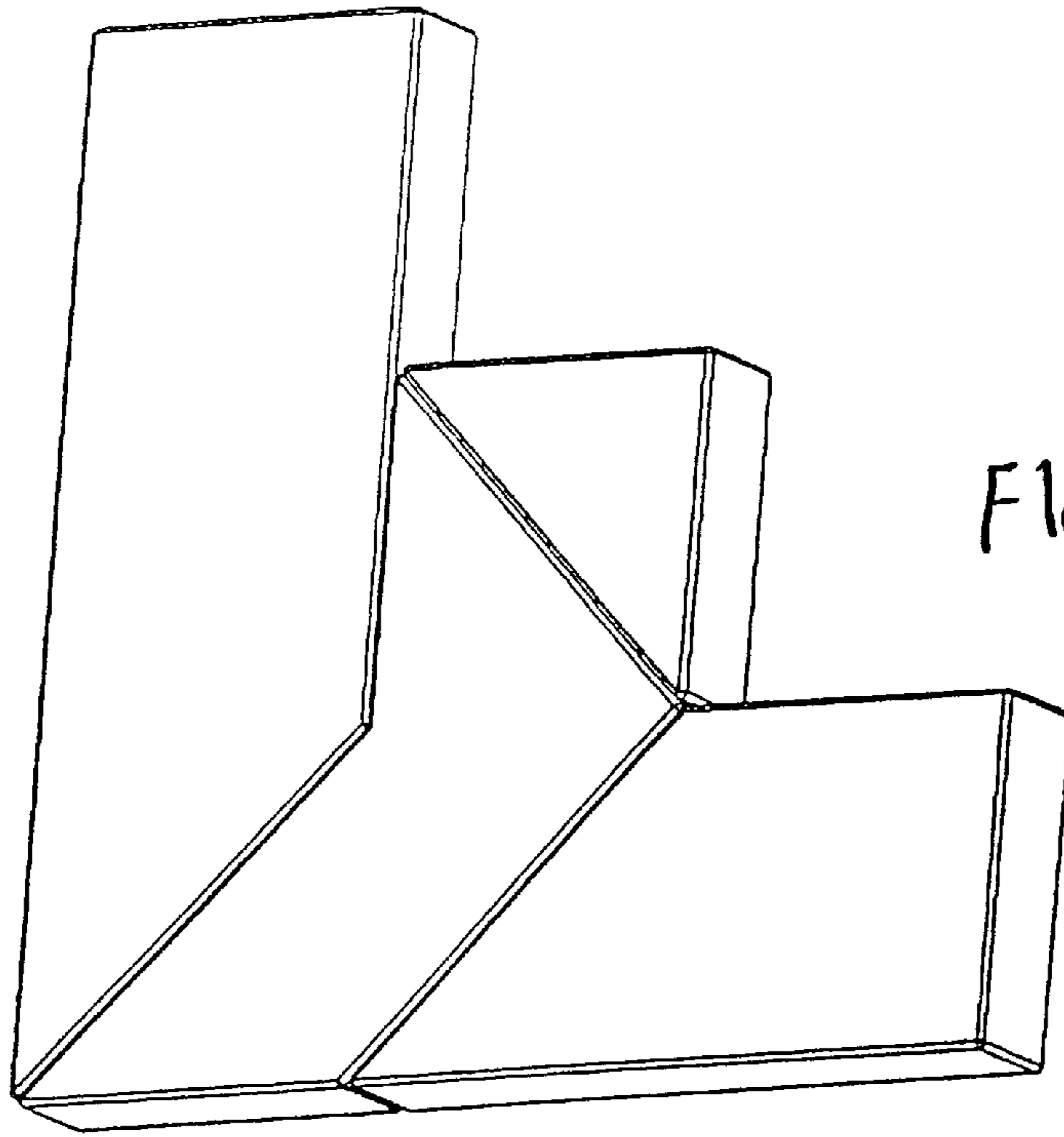

FIG. 29

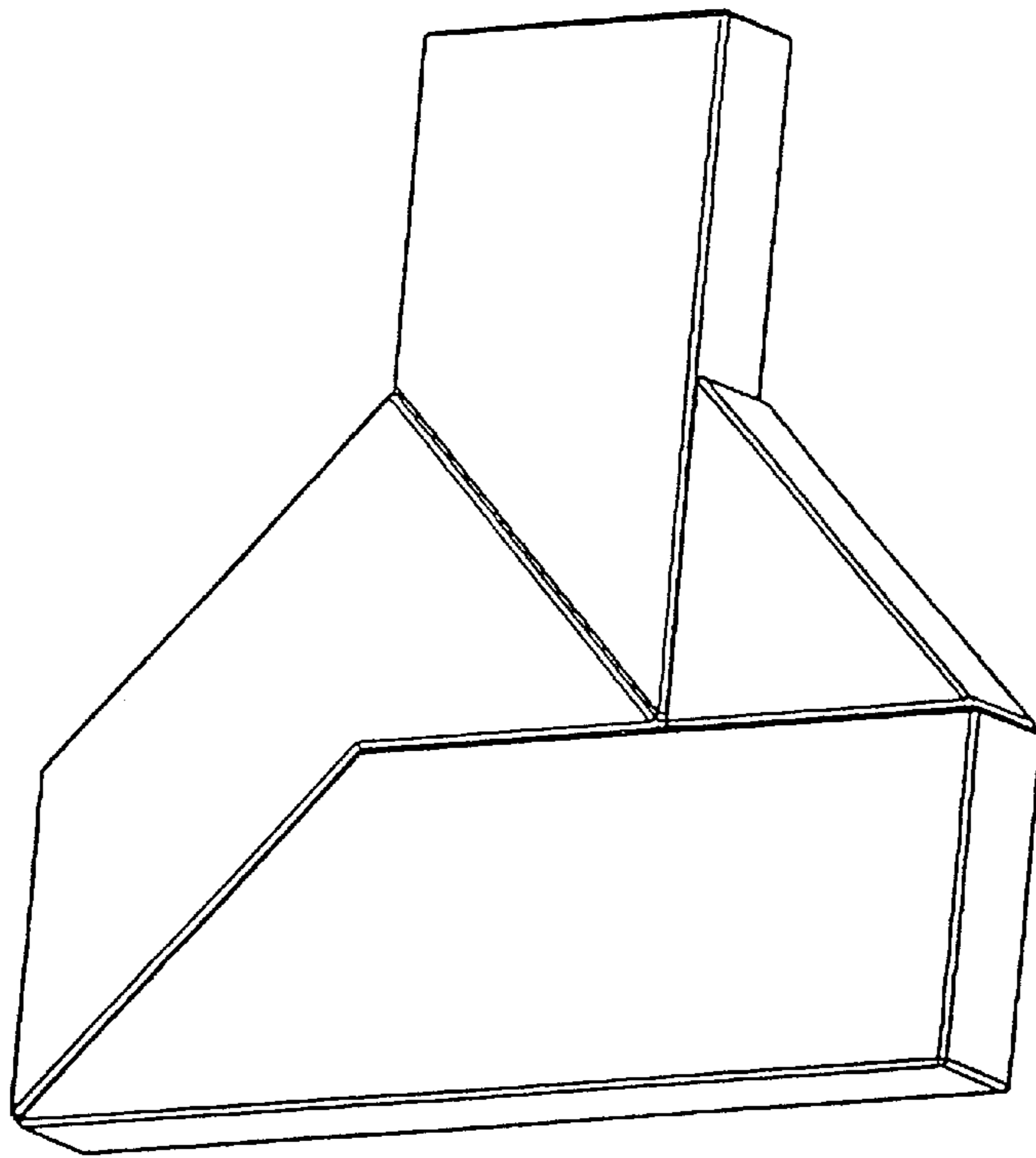

FIG. 30

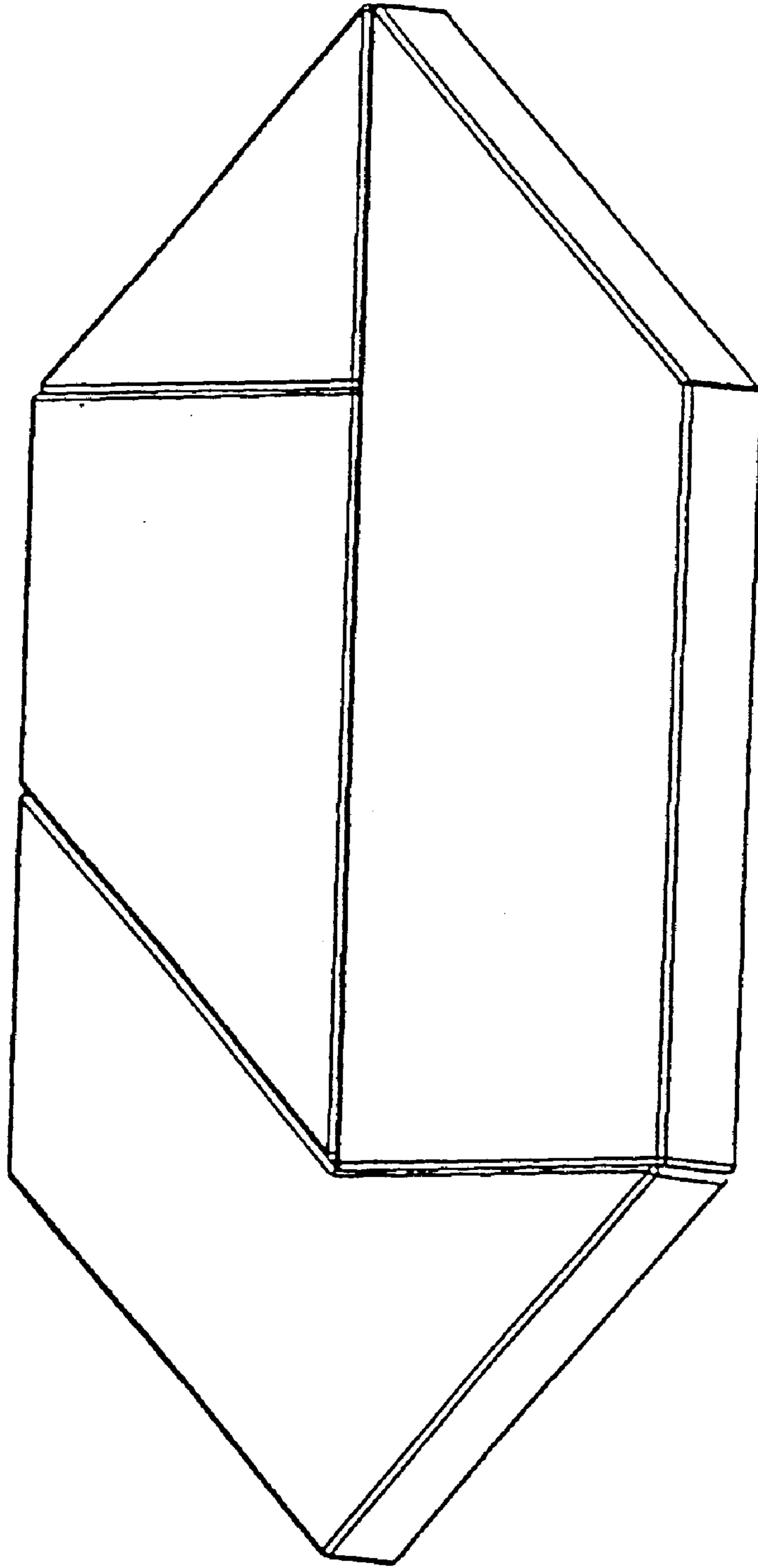

FIG. 31

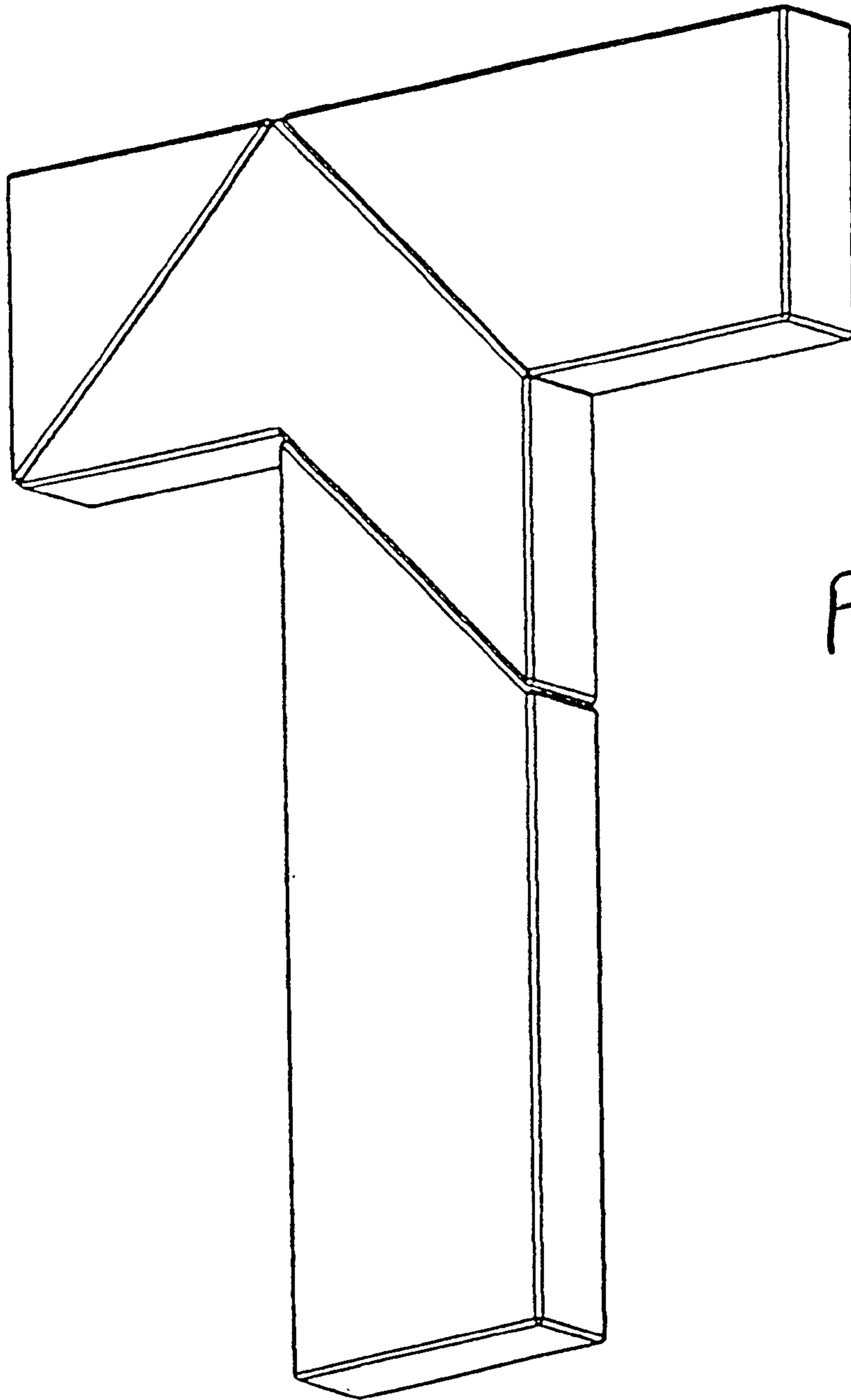
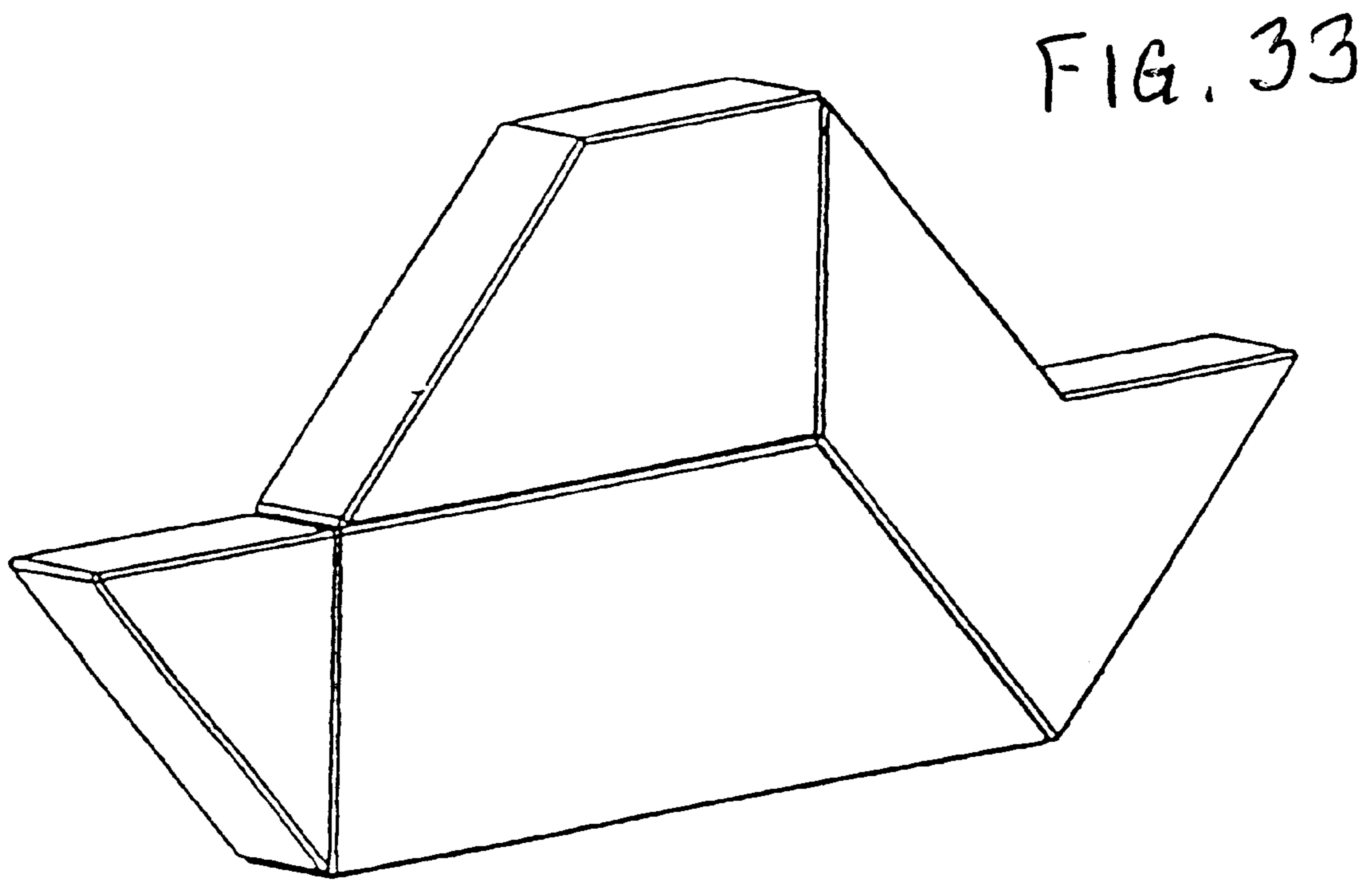
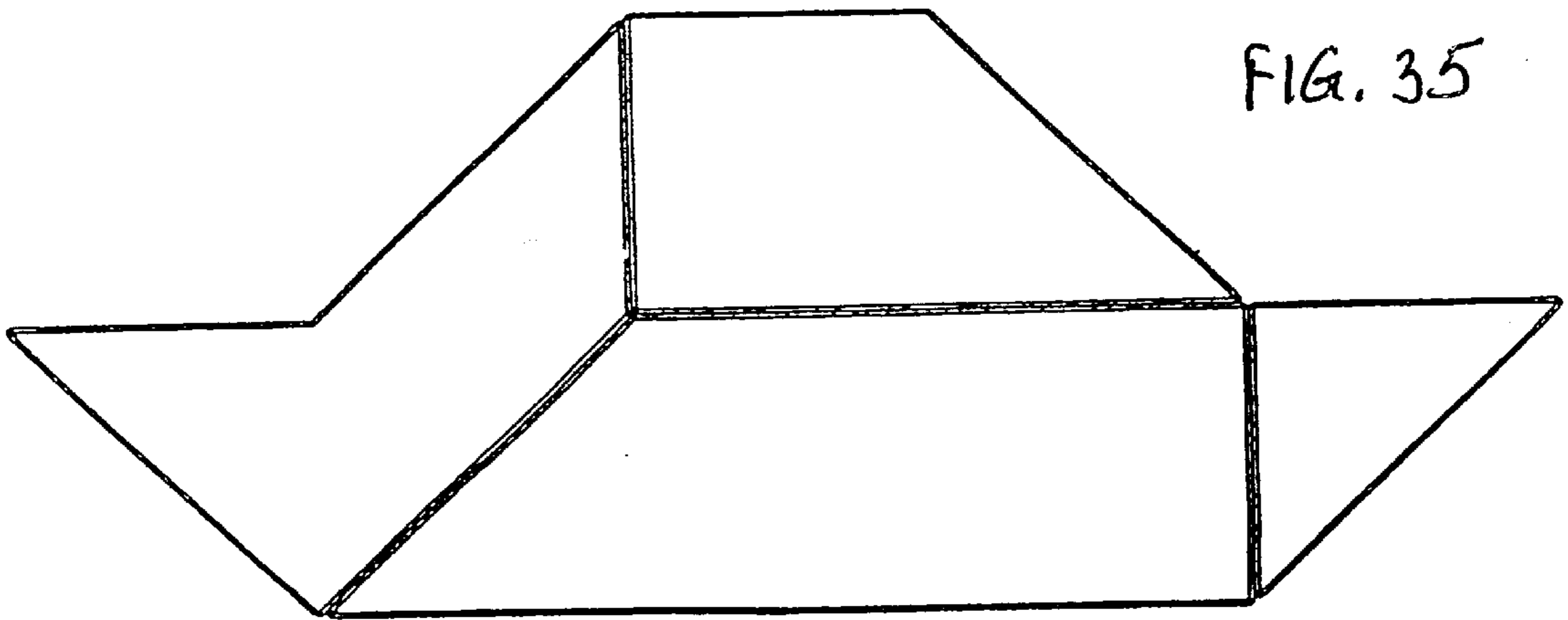
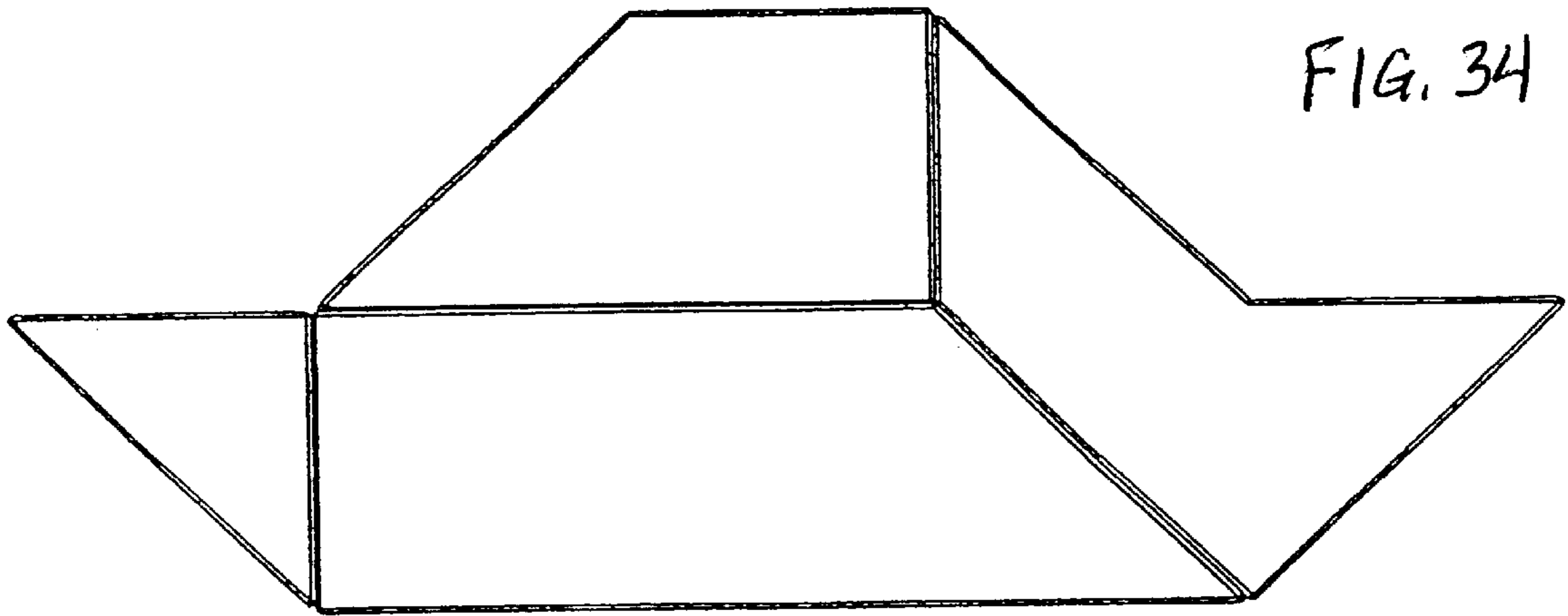

FIG. 32







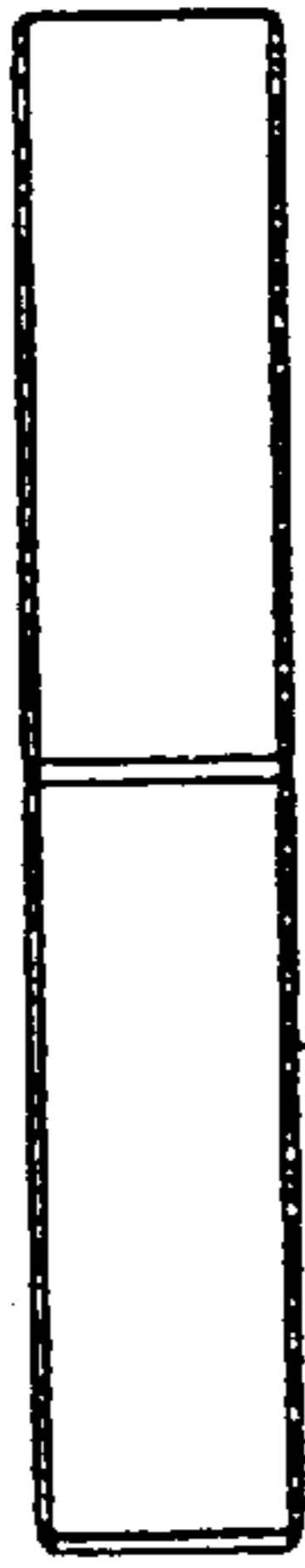

FIG. 36

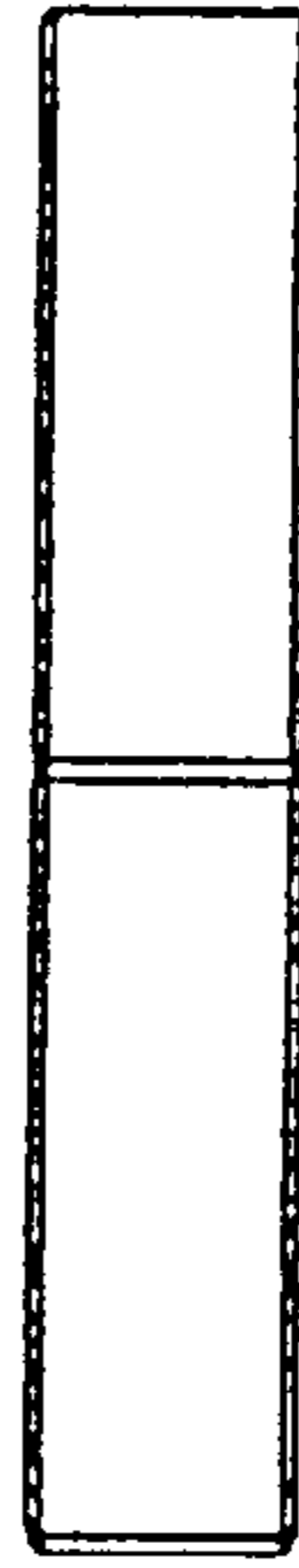

FIG. 37



FIG. 38



FIG. 39