



US00D432578S

# United States Patent [19] Stravitz

[11] Patent Number: Des. 432,578

[45] Date of Patent: \*\* Oct. 24, 2000

[54] BOOK RACK

[76] Inventor: David M. Stravitz, 16 Park Ave. -  
Suite 14A, New York, N.Y. 10016

[\*\*] Term: 14 Years

[21] Appl. No.: 29/115,129

[22] Filed: Dec. 8, 1999

[51] LOC (7) Cl. .... 19-02

[52] U.S. Cl. .... D19/91; D19/90

[58] Field of Search ..... D6/300, 419, 420,  
D6/405; D19/35, 36, 65, 75, 78, 86, 90,  
91, 95, 99, 100; 211/10, 11, 44, 45, 50,  
55, 128.1, 42; 248/441.1, 450, 469

[56] **References Cited**

U.S. PATENT DOCUMENTS

D. 202,315	9/1965	Tucker	.....	D19/90
D. 236,112	7/1975	Staats	.....	D19/75
D. 250,960	1/1979	Bitner, Jr. et al.	.....	D19/90
D. 286,167	10/1986	Greitzer	.....	D21/392
D. 381,212	7/1997	Pagano	.....	D6/300

D. 389,870	1/1998	Hart et al.	.....	D19/90
D. 410,685	6/1999	Thorp et al.	.....	D19/90
D. 758,781	6/1998	Lord et al.	.....	211/55
5,971,171	10/1999	Thorp et al.	.....	211/128.1

Primary Examiner—Martie K. Holtje  
Attorney, Agent, or Firm—Frishauf, Holtz, Goodman,  
Langer & Chick, P.C

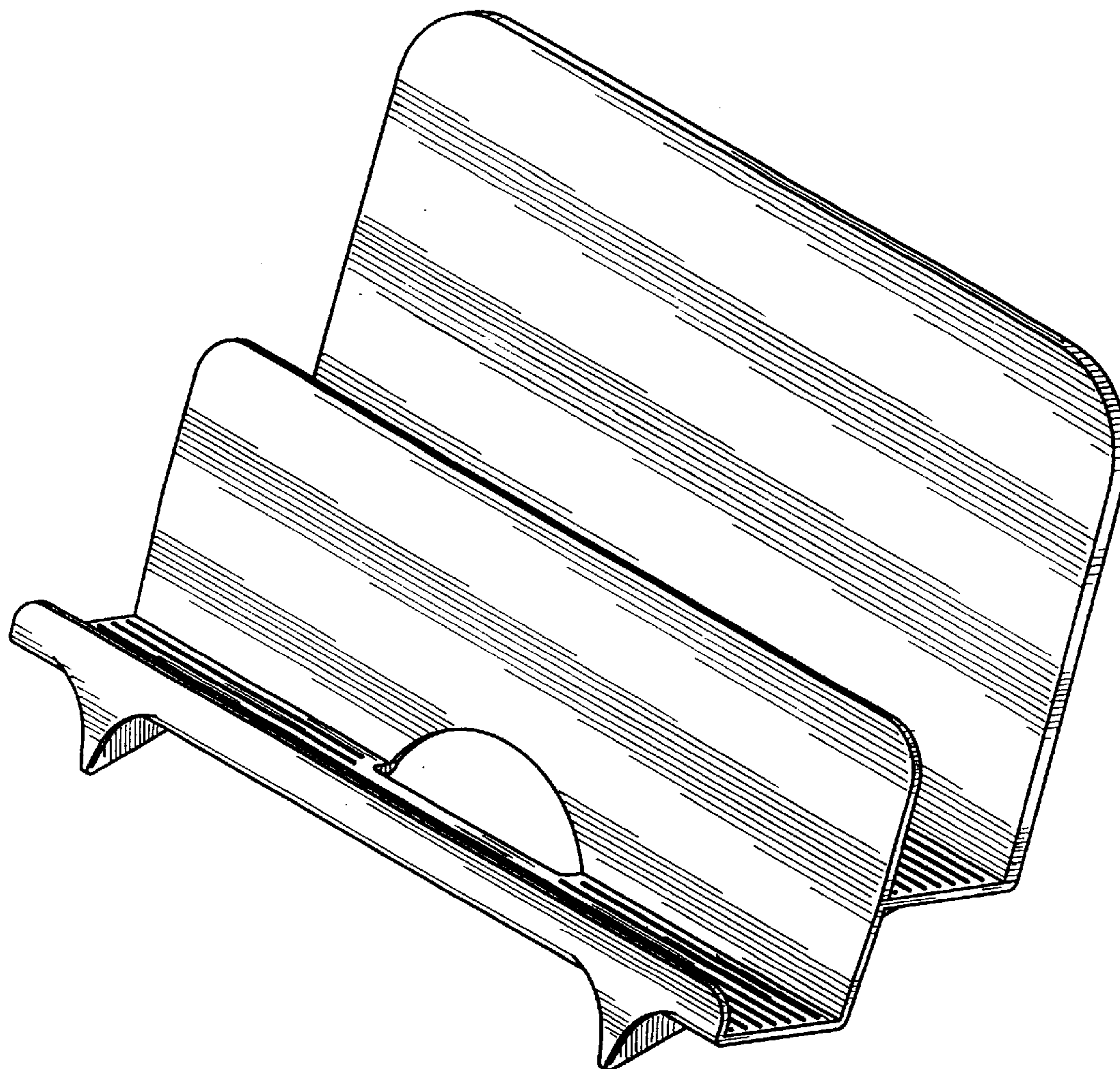
[57] **CLAIM**

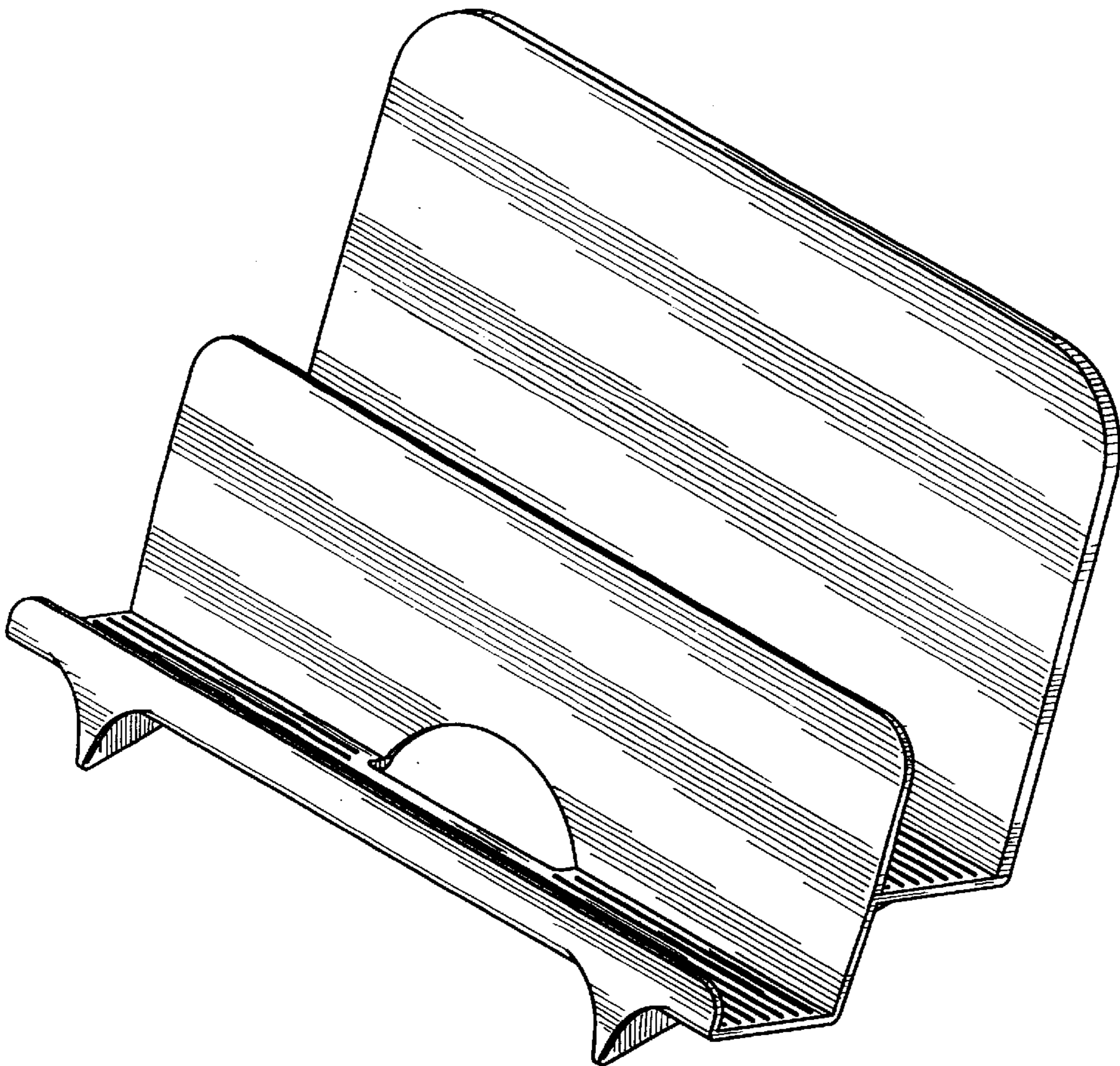
The ornamental design for a book rack, as shown and described.

**DESCRIPTION**

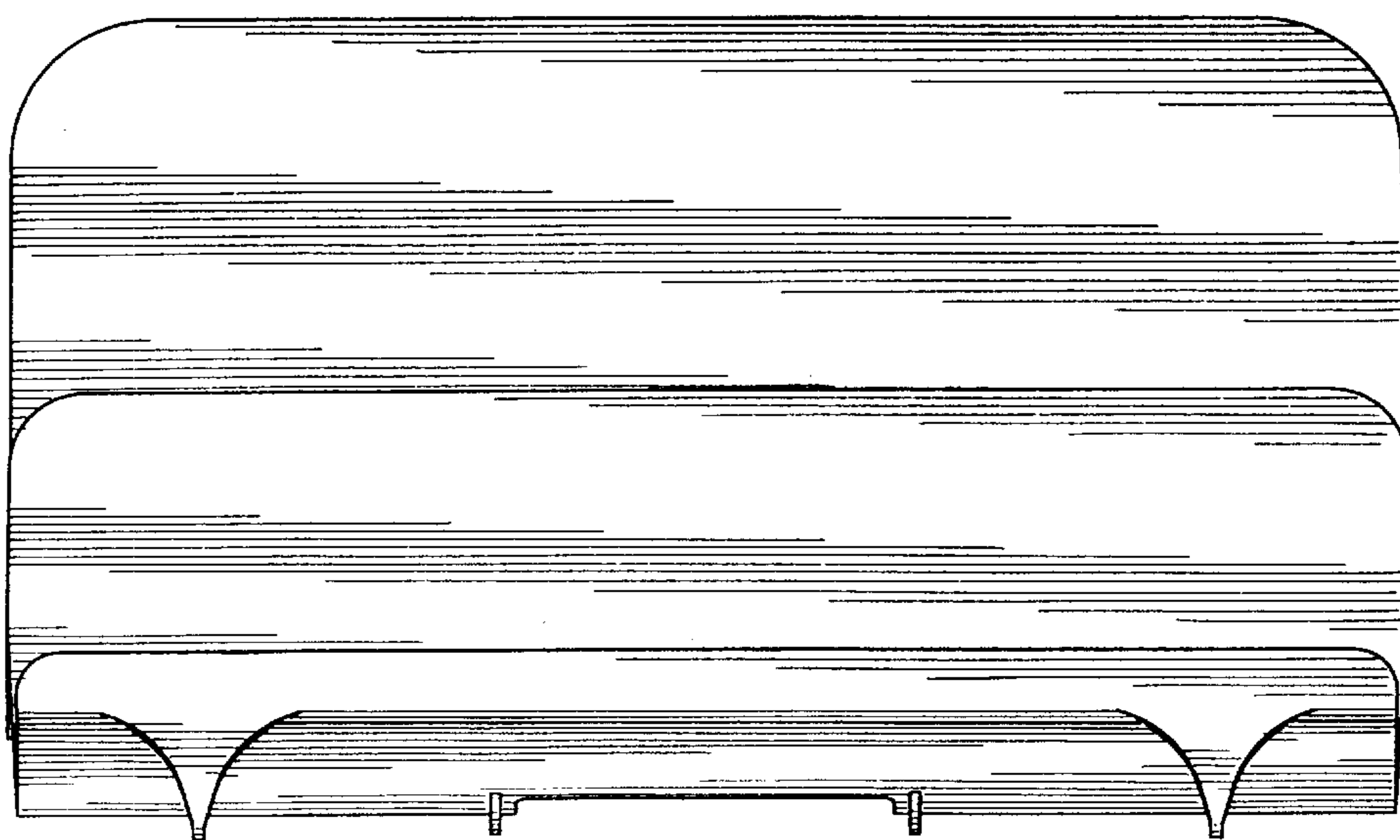
FIG. 1 is a top, front, right side perspective view of a book rack showing my new design;  
FIG. 2 is a front elevational view thereof;  
FIG. 3 is a left side elevational view thereof, the right side elevational view being a mirror image thereof;  
FIG. 4 is a rear elevational view thereof;  
FIG. 5 is a top plan view thereof;  
FIG. 6 is a bottom plan view thereof; and,  
FIG. 7 is a bottom, rear, right side perspective view thereof.

1 Claim, 4 Drawing Sheets

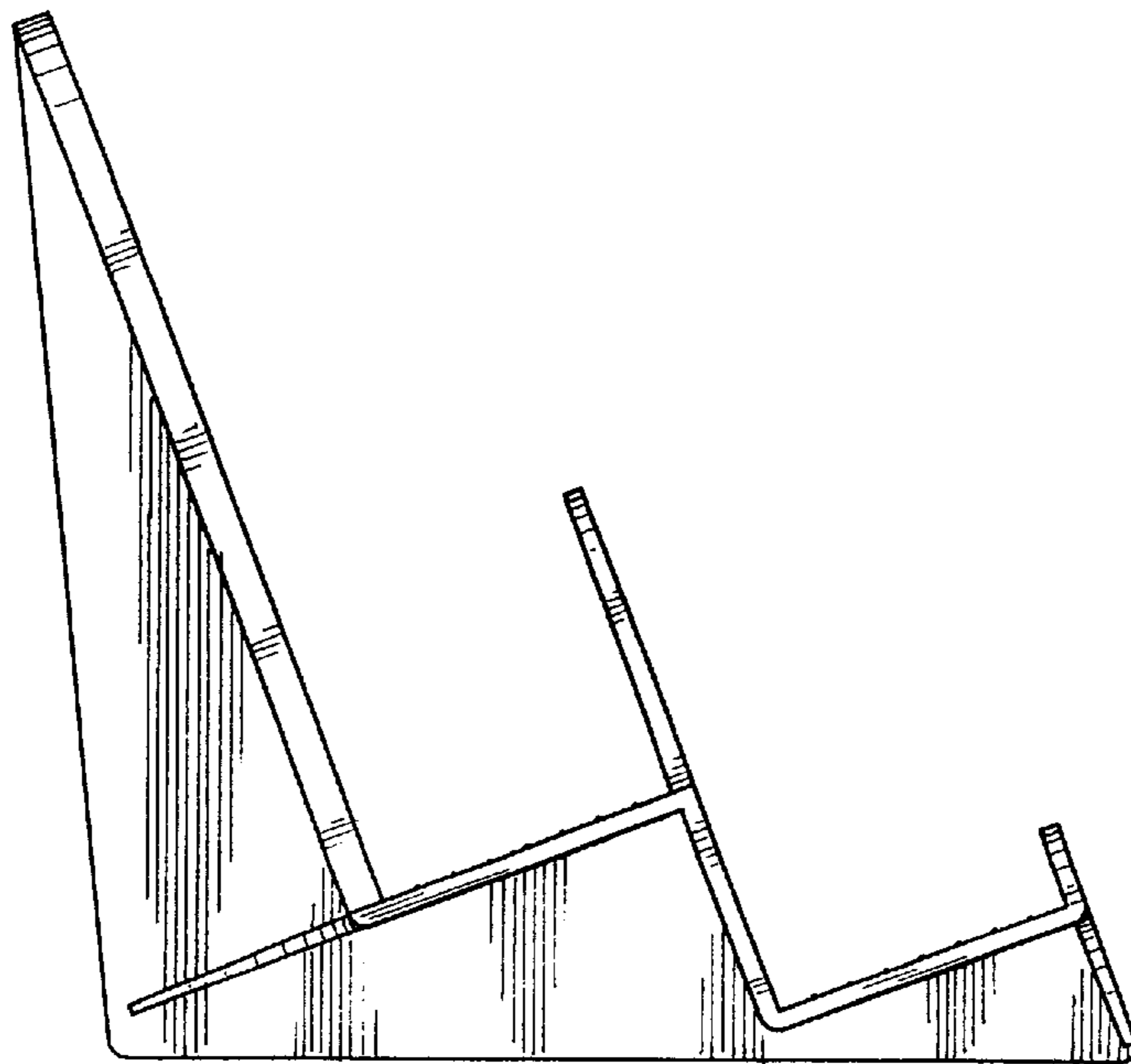




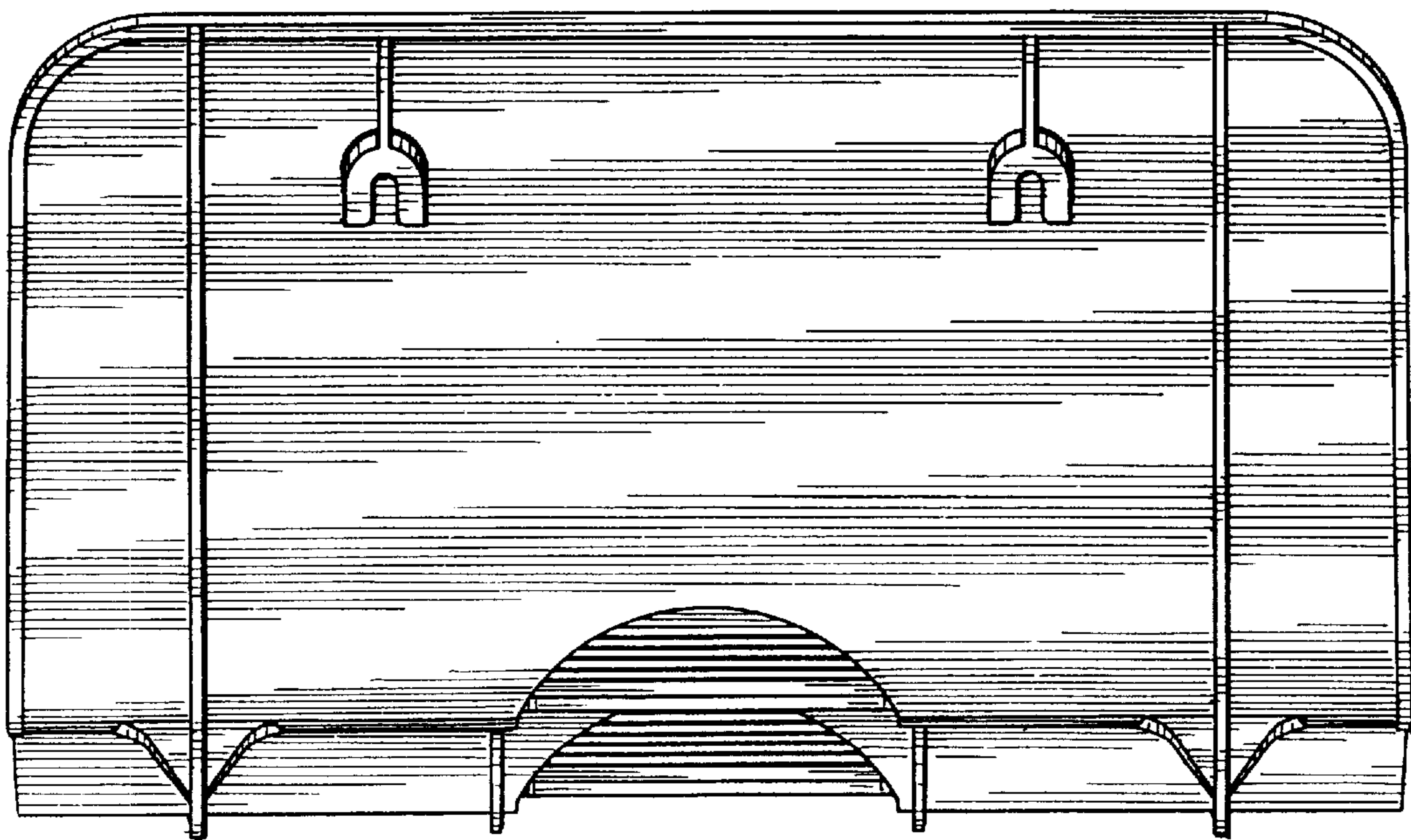
*Fig. 1*



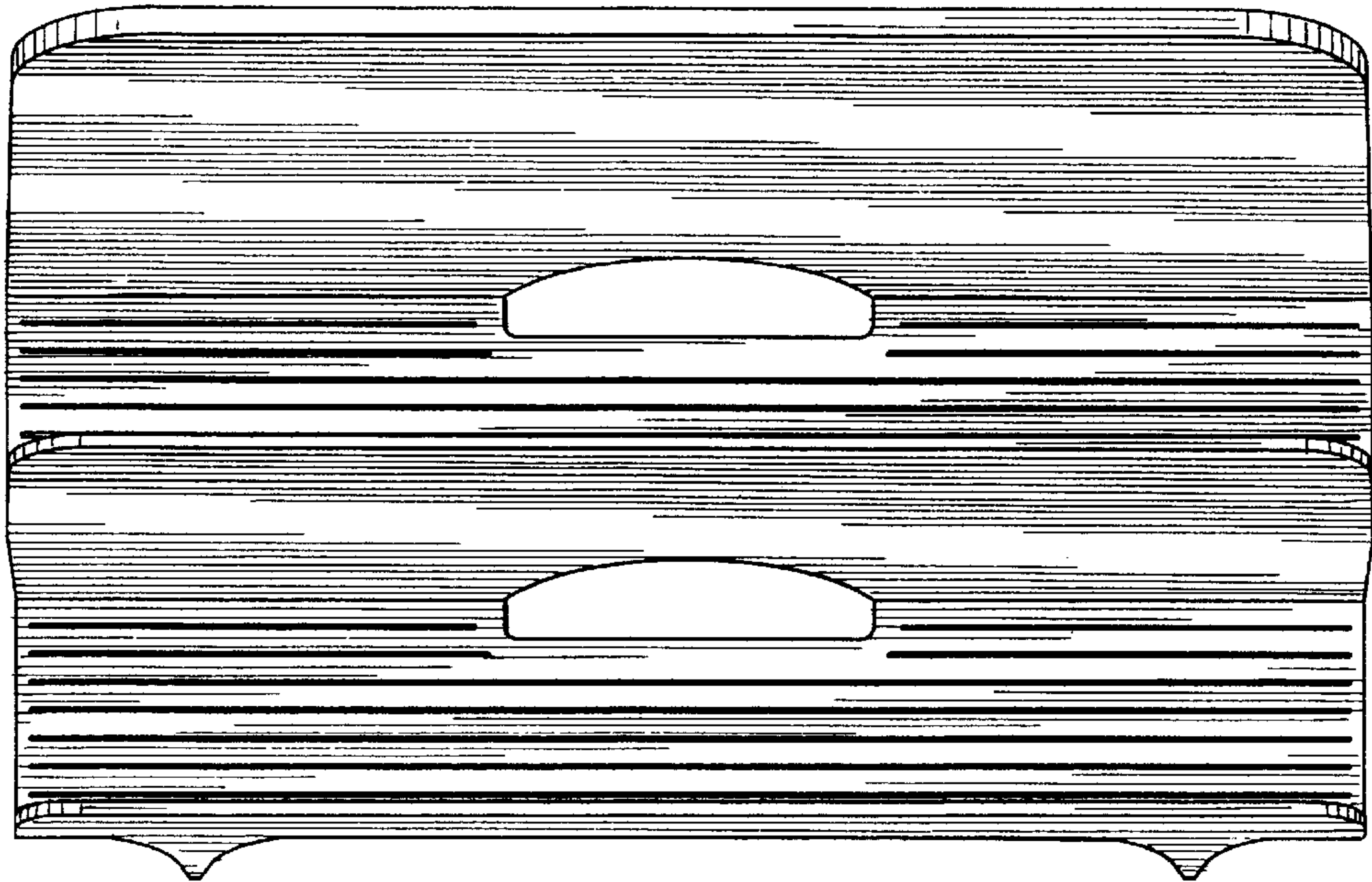
*Fig. 2*



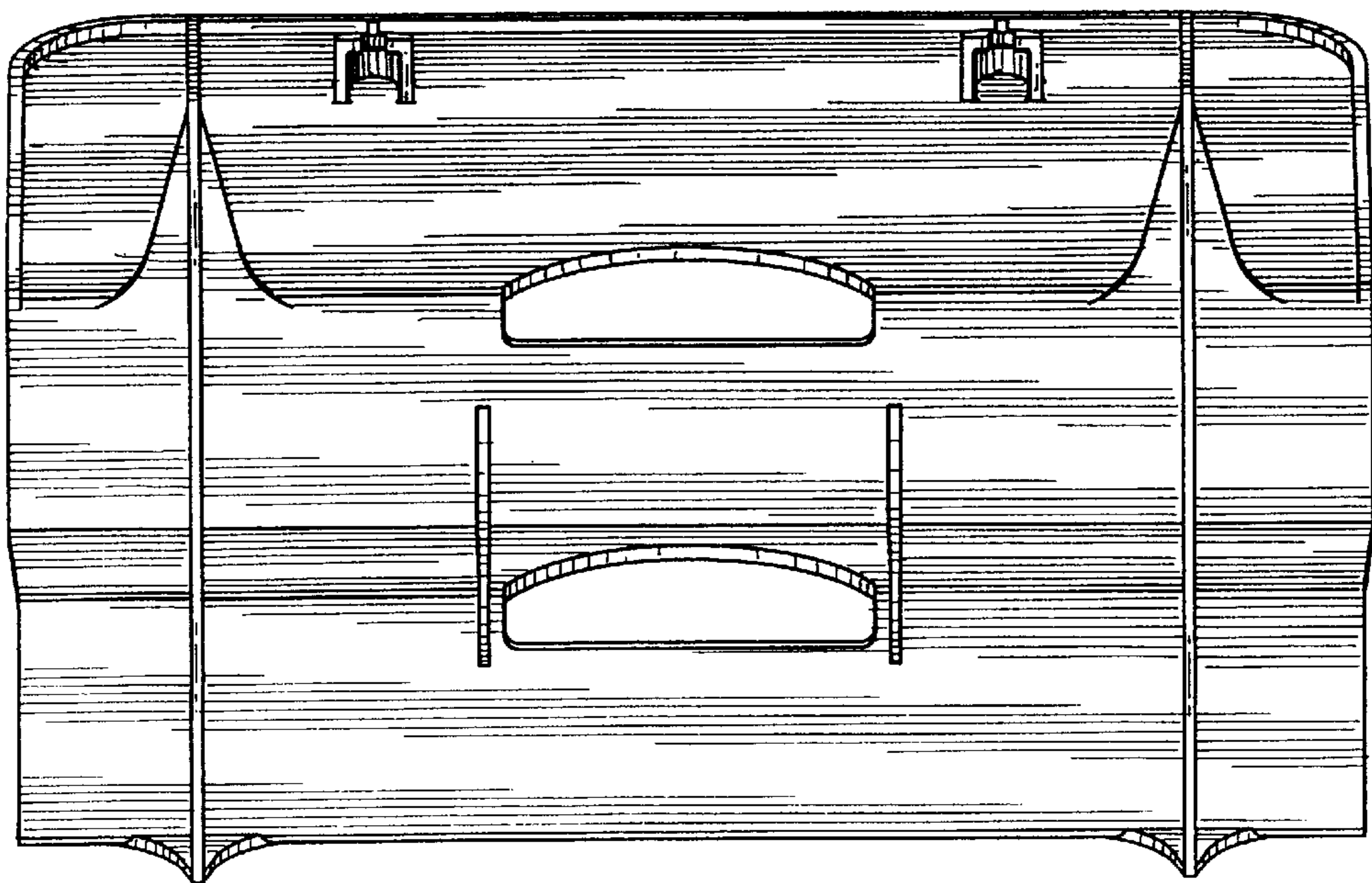
*Fig. 3*



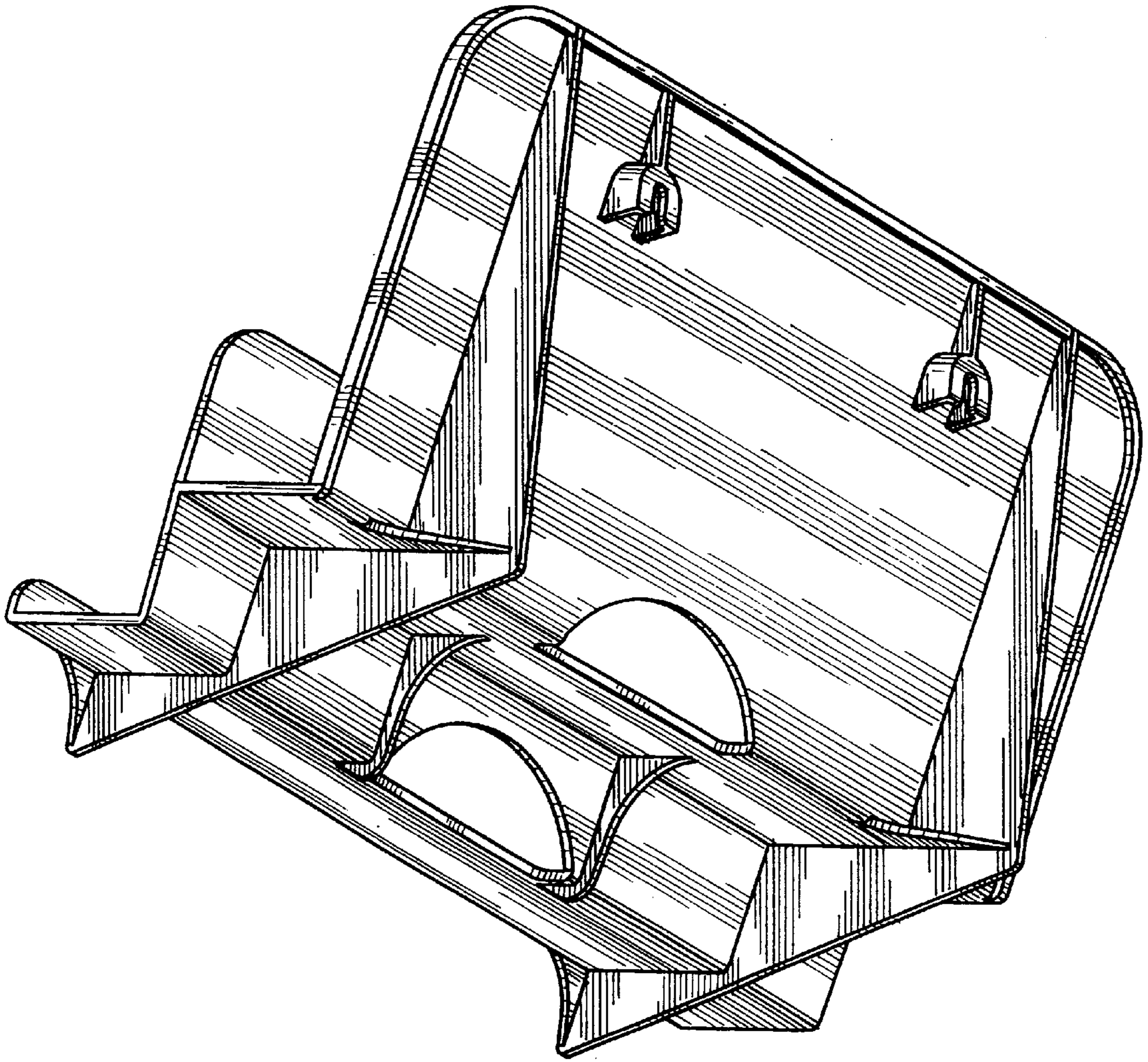
*Fig. 4*



*Fig. 5*



*Fig. 6*



*Fig. 7*