



US00D432540S

# United States Patent [19]

Laity et al.

[11] **Patent Number: Des. 432,540**

[45] **Date of Patent: \*\* Oct. 24, 2000**

[54] **PC CARD**

[75] Inventors: **Ian A. Laity**, Simi Valley; **David Roth**; **Joakim Ahlstrom**, both of Pasadena, all of Calif.

[73] Assignee: **Xircom, Inc.**, Thousand Oaks, Calif.

[\*\*] Term: **14 Years**

[21] Appl. No.: **29/085,265**

[22] Filed: **Mar. 19, 1998**

- D. 378,085 2/1997 Kerklaan et al. .
- D. 398,592 9/1998 Klinker .
- D. 413,879 9/1999 Wu .
- D. 415,132 10/1999 Homma et al. .
- D. 415,479 10/1999 Yang et al. .
- D. 425,045 5/2000 Ting .

*Primary Examiner*—M. H. Tung  
*Attorney, Agent, or Firm*—Hogan & Hartson LLP

### Related U.S. Application Data

[63] Continuation-in-part of application No. 08/971,501, Nov. 17, 1997, Pat. No. 5,984,731.

[51] **LOC (7) Cl.** ..... **14-02**

[52] **U.S. Cl.** ..... **D14/436**

[58] **Field of Search** ..... D14/114, 117, D14/107, 256, 436, 432; D13/146-7, 199, 164, 103, 182; 359/152-4, 170; 361/685-6, 730, 736, 752, 728, 737; 235/492, 487, 380-1, 441; 439/676, 638, 946

### [56] **References Cited**

#### U.S. PATENT DOCUMENTS

D. 370,904 6/1996 Nakata et al. .

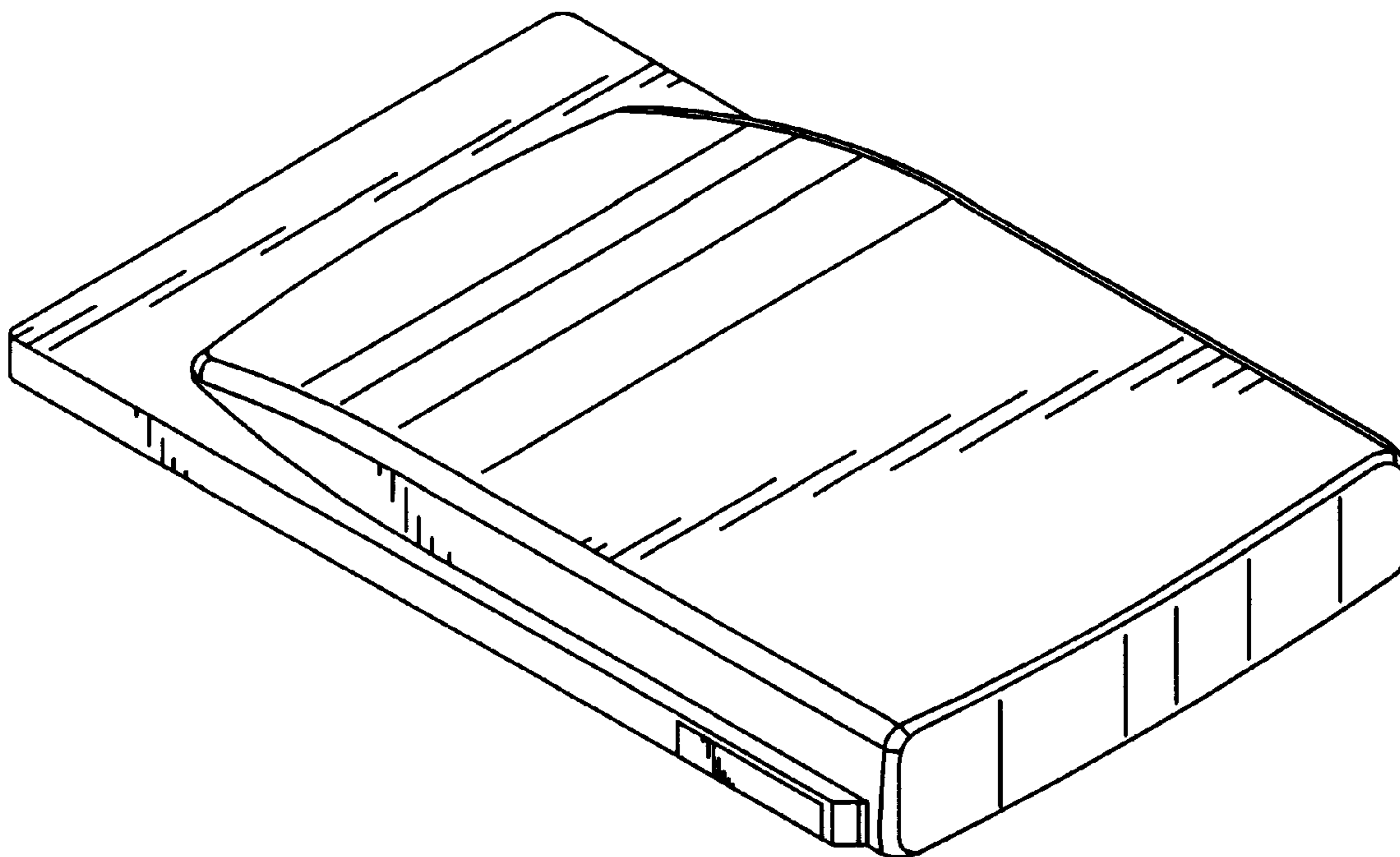
### [57] **CLAIM**

The design for a PC card, substantially as shown and described.

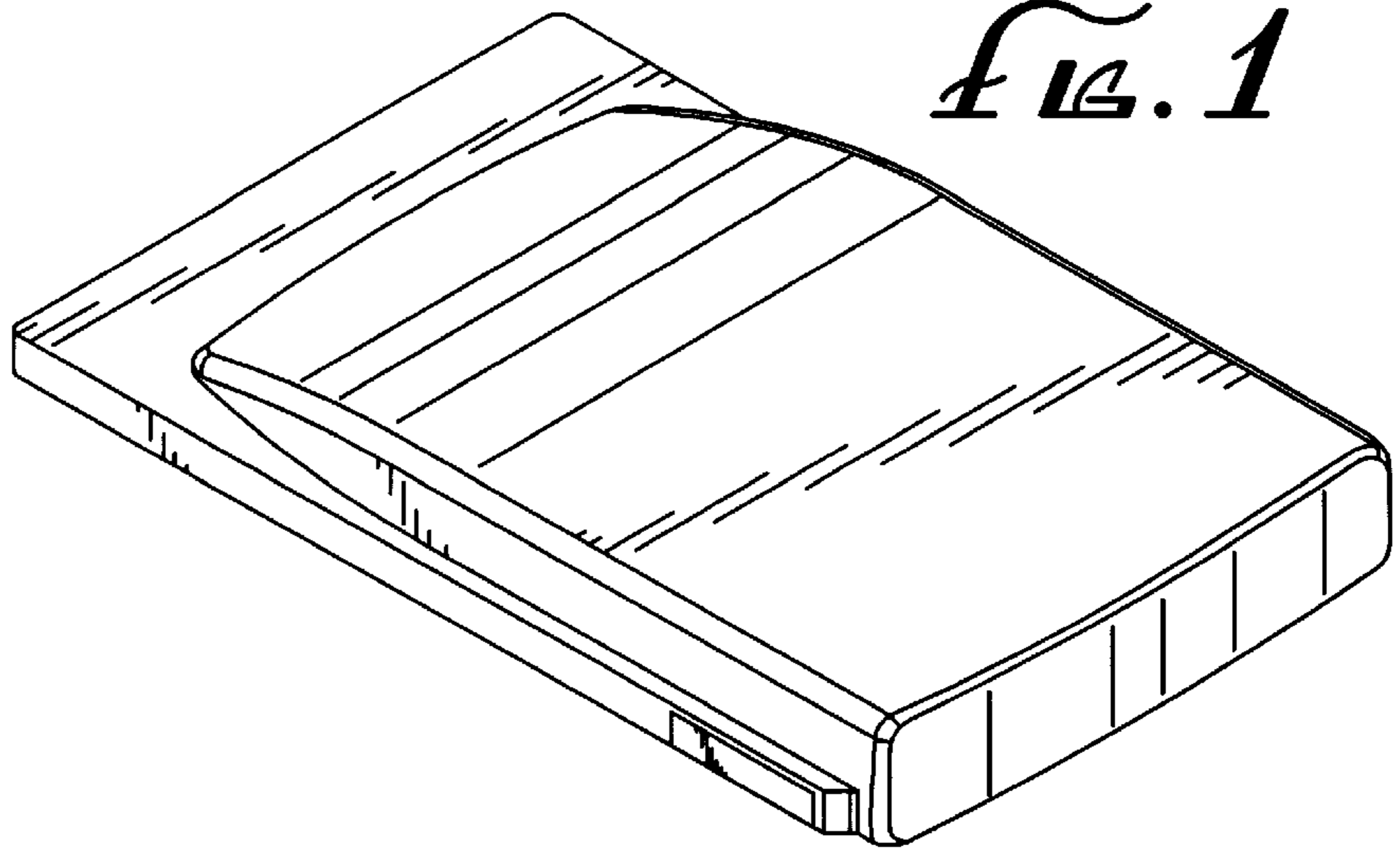
### DESCRIPTION

FIG. 1 is a perspective view showing our new design;  
 FIG. 2 is another perspective view thereof;  
 FIG. 3 is a top plan view thereof;  
 FIG. 4 is a rear elevation view thereof;  
 FIG. 5 is a right side elevation view thereof;  
 FIG. 6 is a left side elevation view thereof;  
 FIG. 7 is a front elevation view thereof; and,  
 FIG. 8 is a bottom plan view thereof.

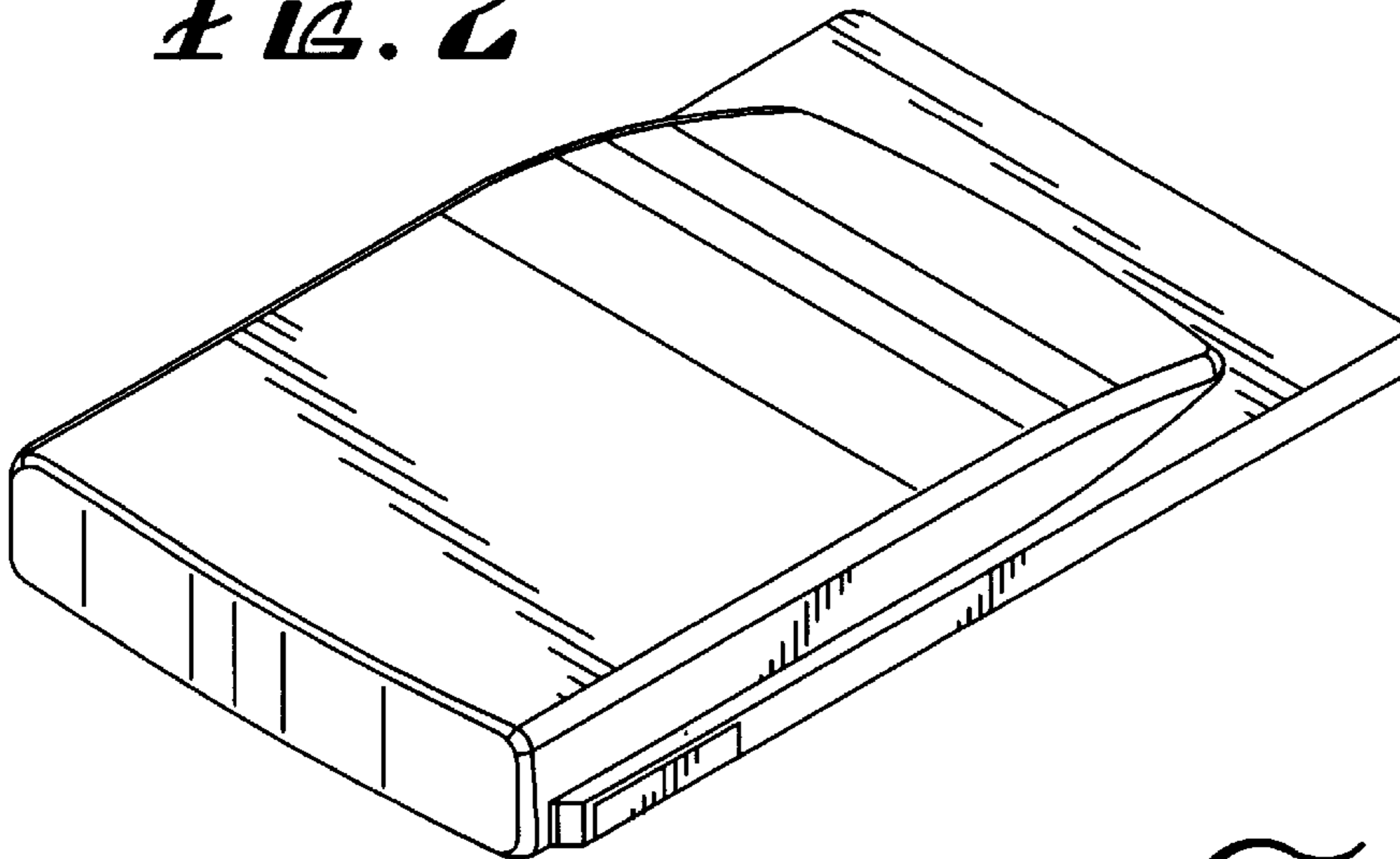
**1 Claim, 2 Drawing Sheets**



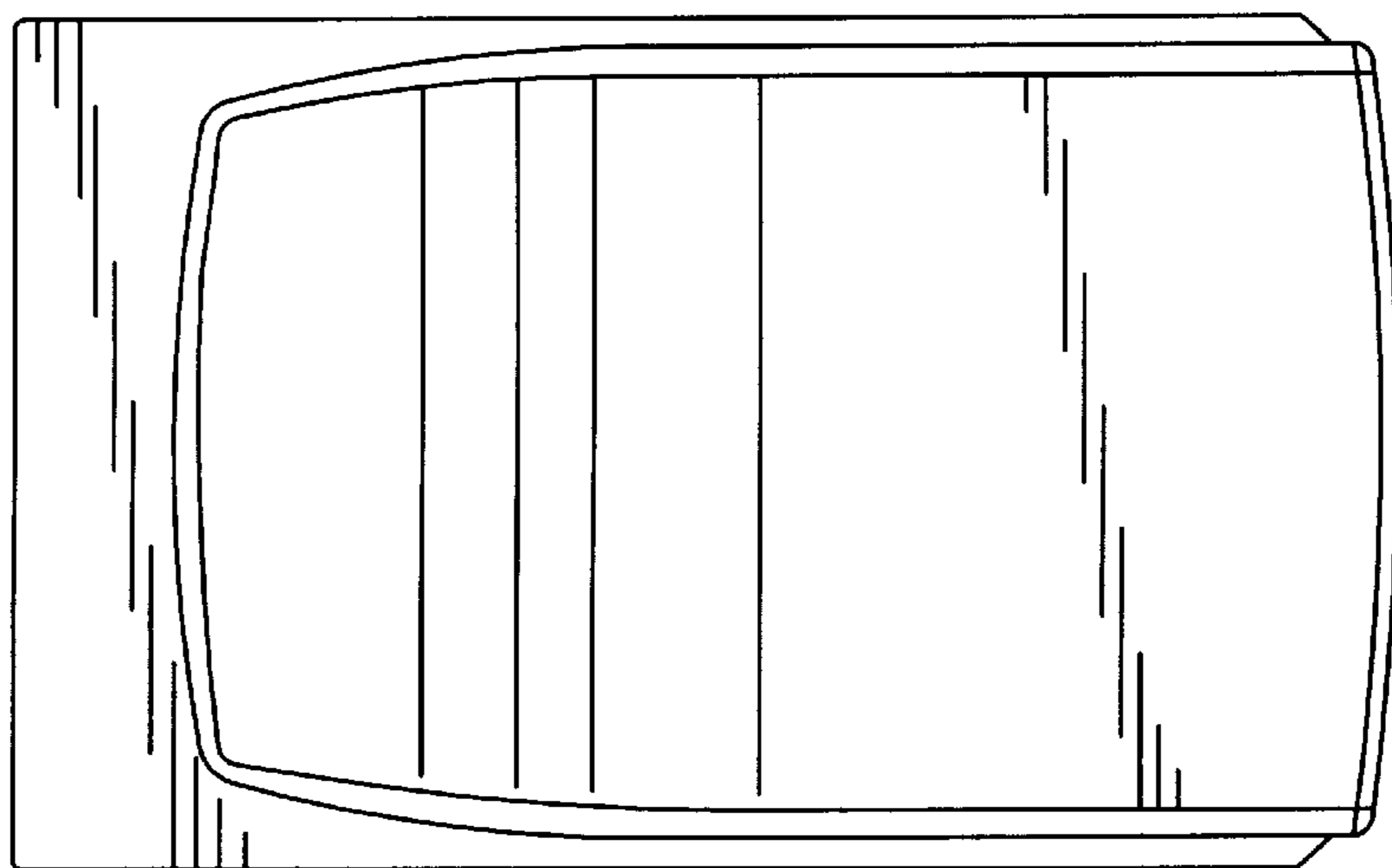
*FIG. 1*

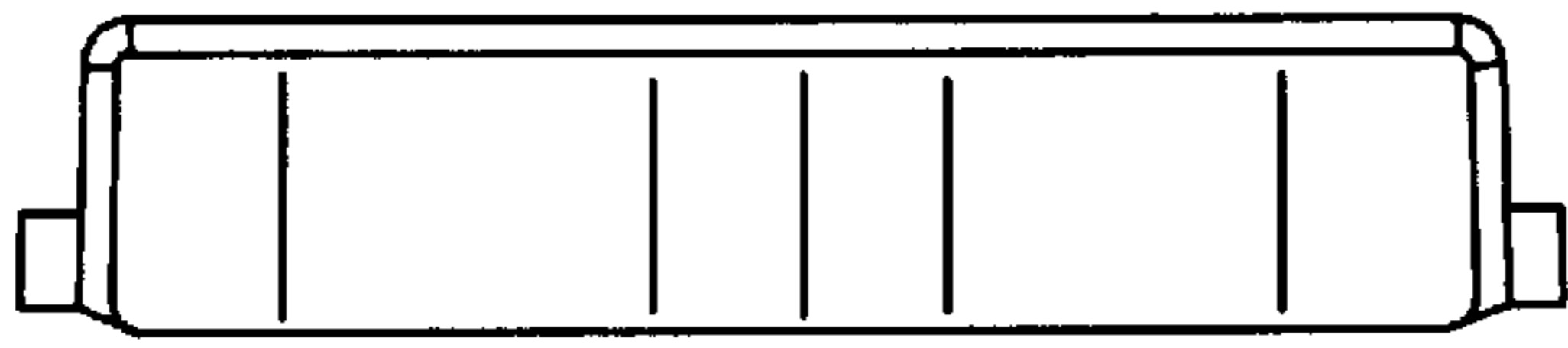


*FIG. 2*

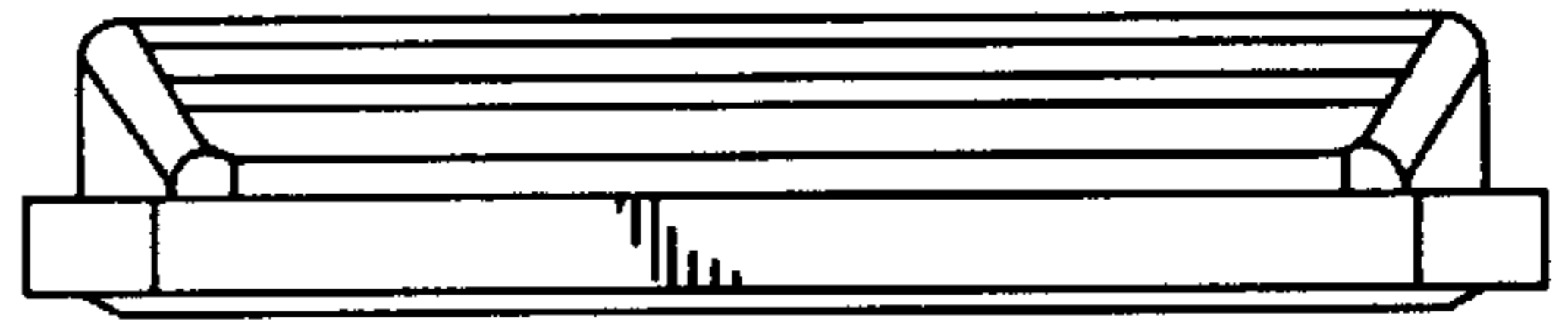


*FIG. 3*



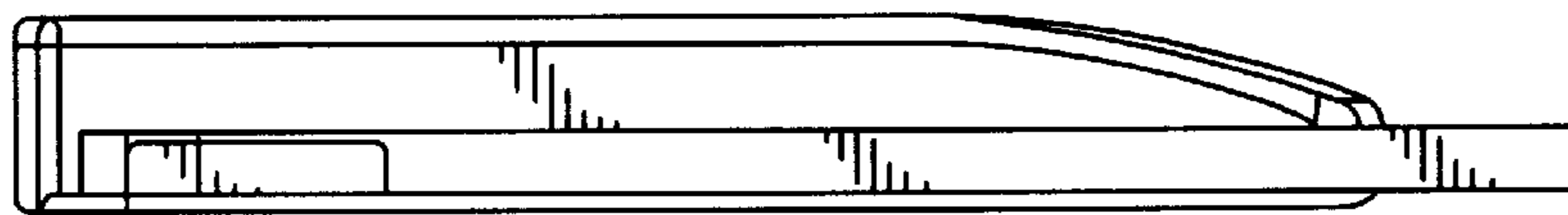


*FIG. 4*

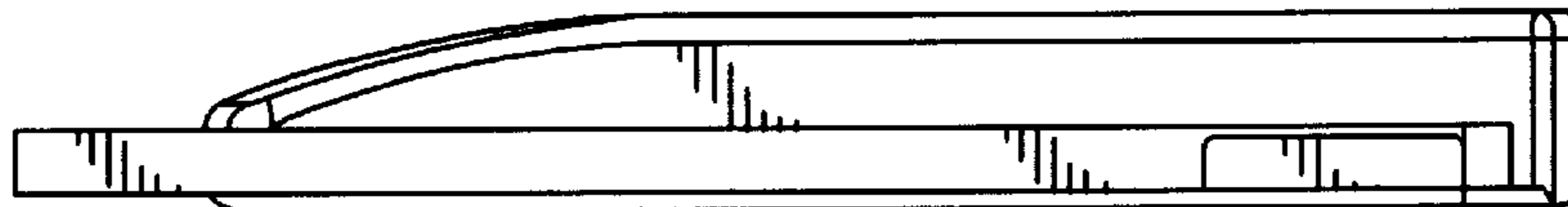


*FIG. 7*

*FIG. 5*



*FIG. 6*



*FIG. 8*

