



US00D432406S

United States Patent [19]

Grattan et al.

[11] **Patent Number: Des. 432,406**

[45] **Date of Patent: ** Oct. 24, 2000**

[54] **BED LEG CUSHION**

[76] Inventors: **Ron Grattan; Heather Grattan**, both of 3829 Charleston Park Dr., Raleigh, N.C. 27604

[**] Term: **14 Years**

[21] Appl. No.: **29/115,653**

[22] Filed: **Dec. 17, 1999**

[51] **LOC (7) Cl. 08-09**

[52] **U.S. Cl. D8/402**

[58] **Field of Search** 16/86 A, 86 R, 16/86 B, 82, 18 CG; 248/188.9, 346.11; D8/450, 402, 374, 403; 24/3.13, 17 B, 442; 2/311

[56] **References Cited**

U.S. PATENT DOCUMENTS

4,991,234	2/1991	Greenberg	2/311
5,845,374	12/1998	Briggs	24/442
5,873,144	2/1999	Tupper et al.	16/18 CG

Primary Examiner—Susan J. Lucas
Assistant Examiner—Jennifer Rivard

[57] **CLAIM**

The ornamental design for a bed leg cushion, as shown and described.

DESCRIPTION

FIG. 1 is a front elevational view of the bed leg cushion of the present invention;
FIG. 2 is a rear elevational view of the bed leg cushion of FIG. 1;
FIG. 3 is a left side elevational view of the bed leg cushion of FIG. 1;
FIG. 4 is a right side elevational view of the bed leg cushion of FIG. 1;
FIG. 5 is a top plan view of the bed leg cushion of FIG. 1;
FIG. 6 is a bottom plan view of the bed leg cushion of FIG. 1; and,
FIG. 7 is a top, front elevational view in an alternate position of the bed leg cushion of FIG. 1.

The broken lines are shown for illustrative purposes only and form no part of the claimed design.

1 Claim, 3 Drawing Sheets

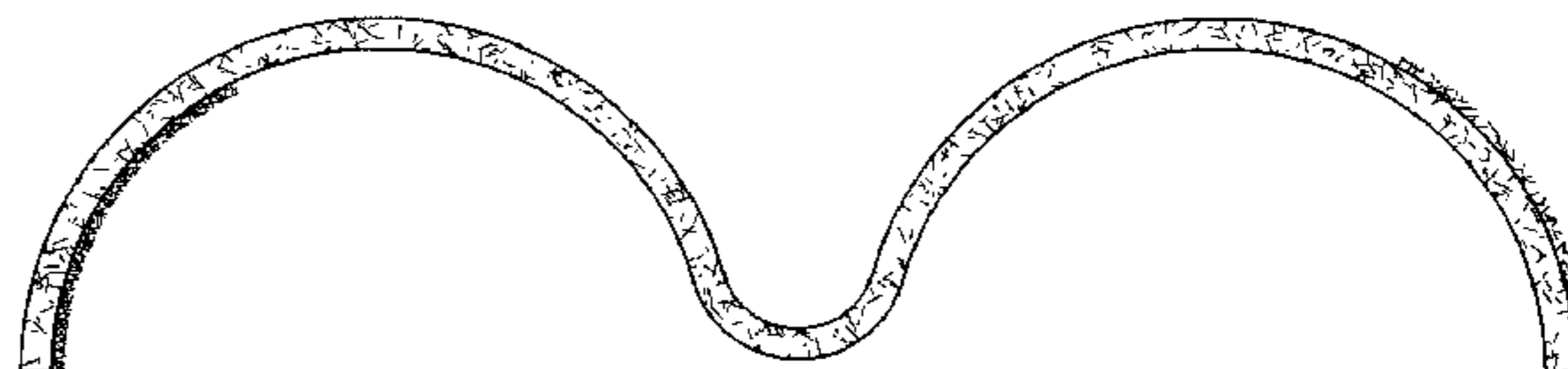
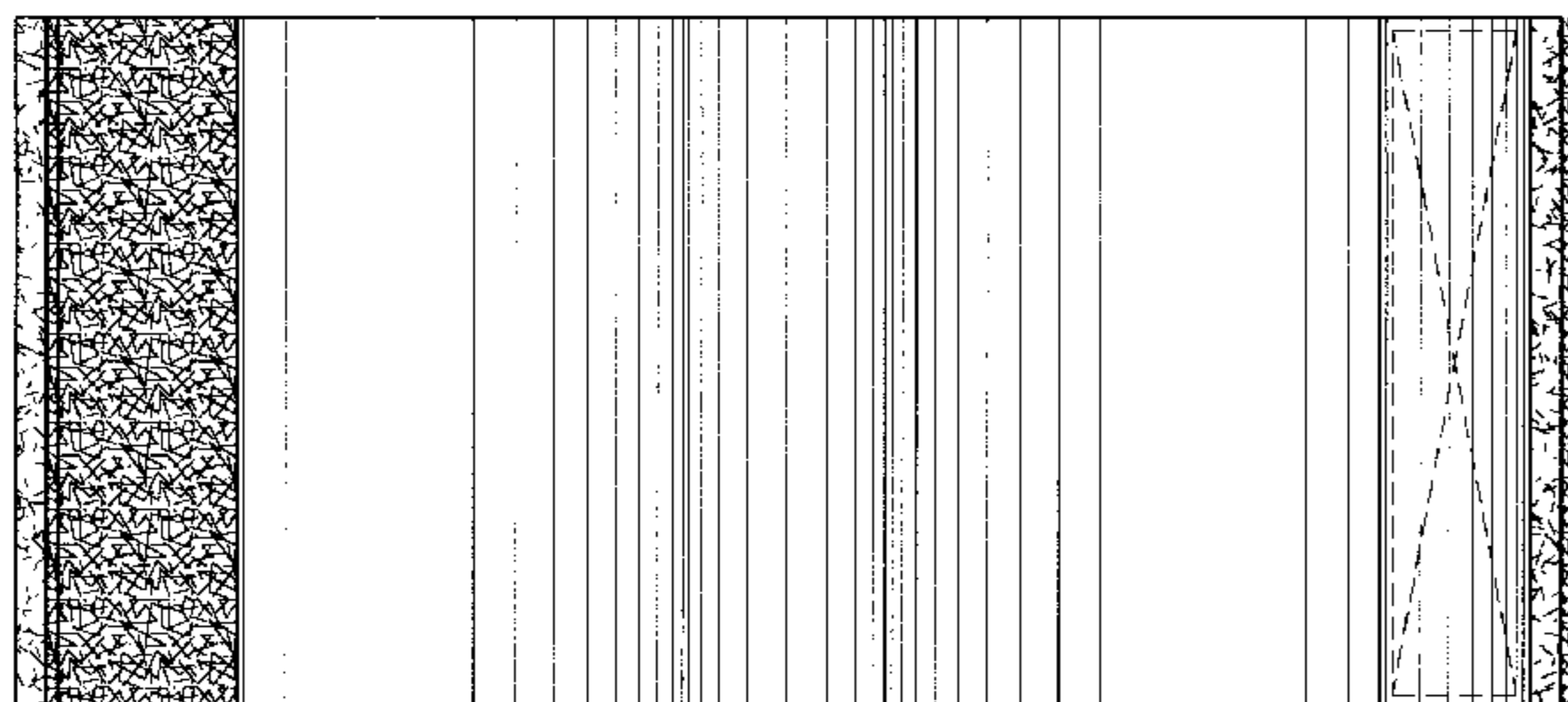

FIG. 1

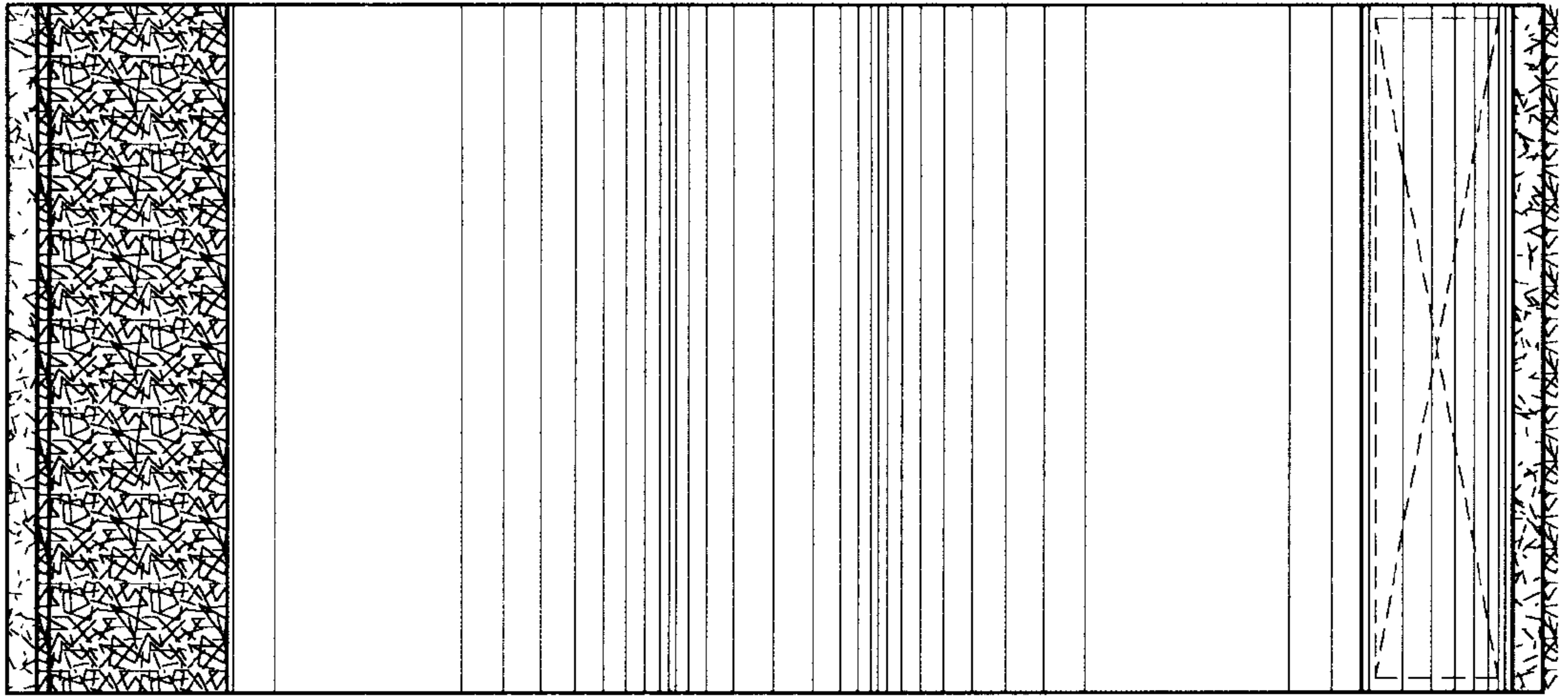

FIG. 2

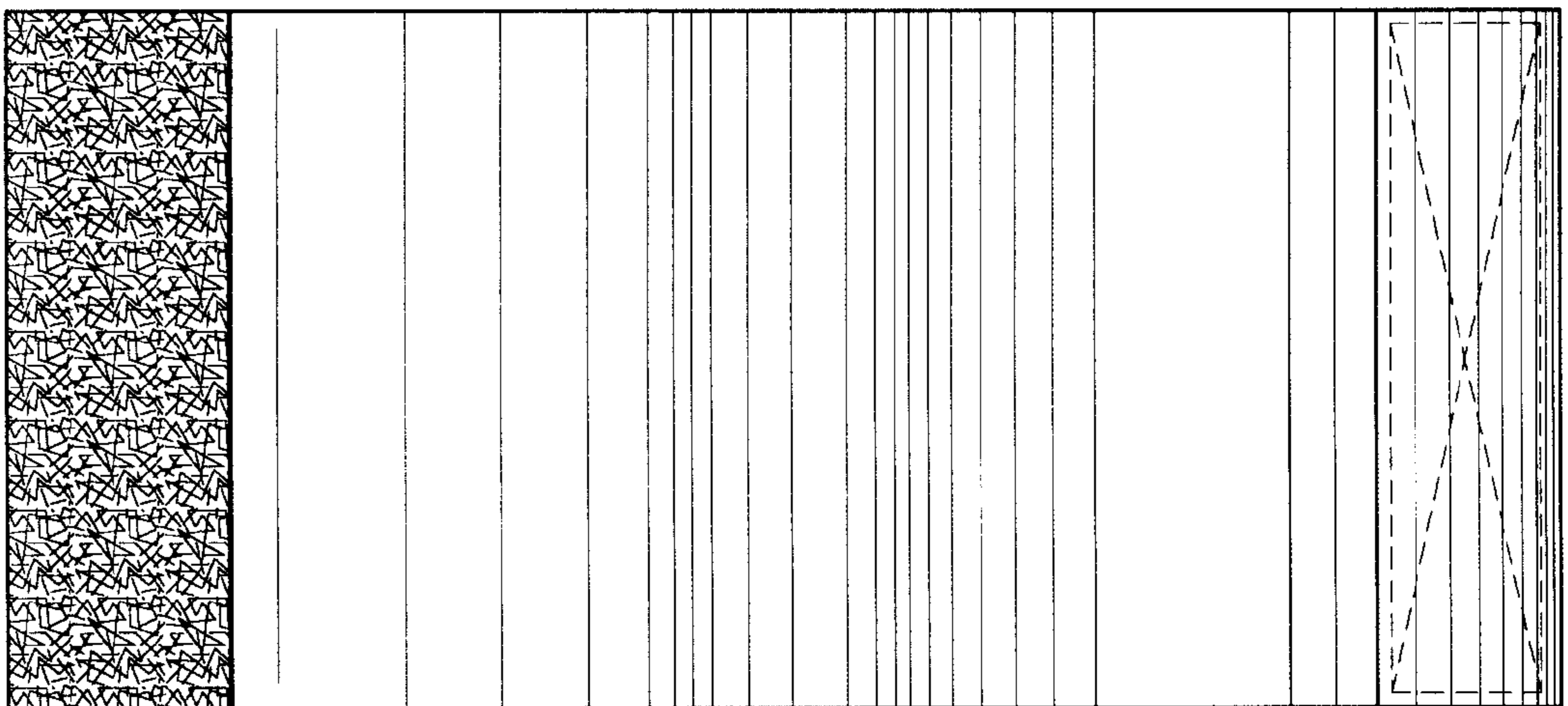

FIG. 3

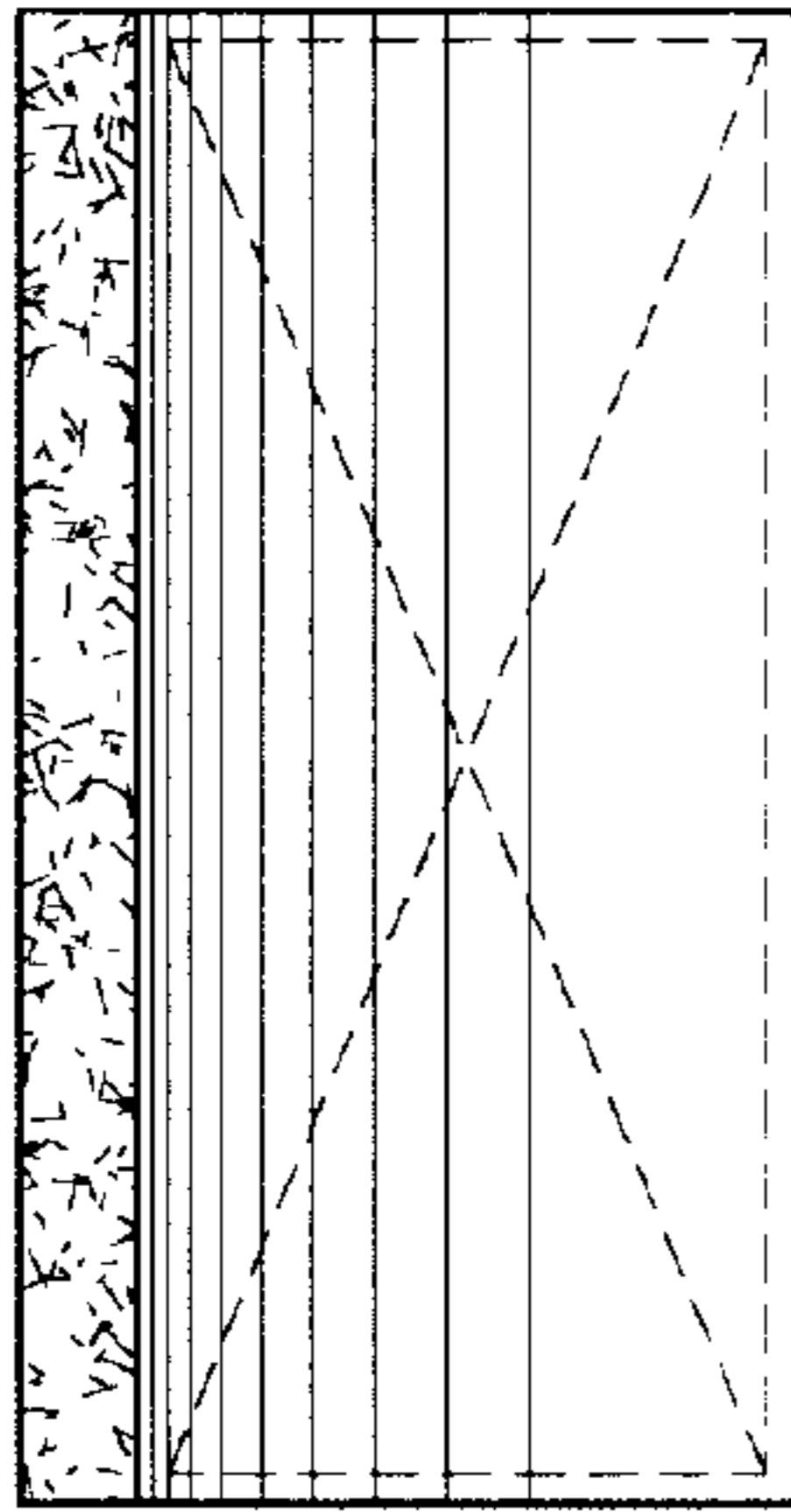

FIG. 4



FIG. 5

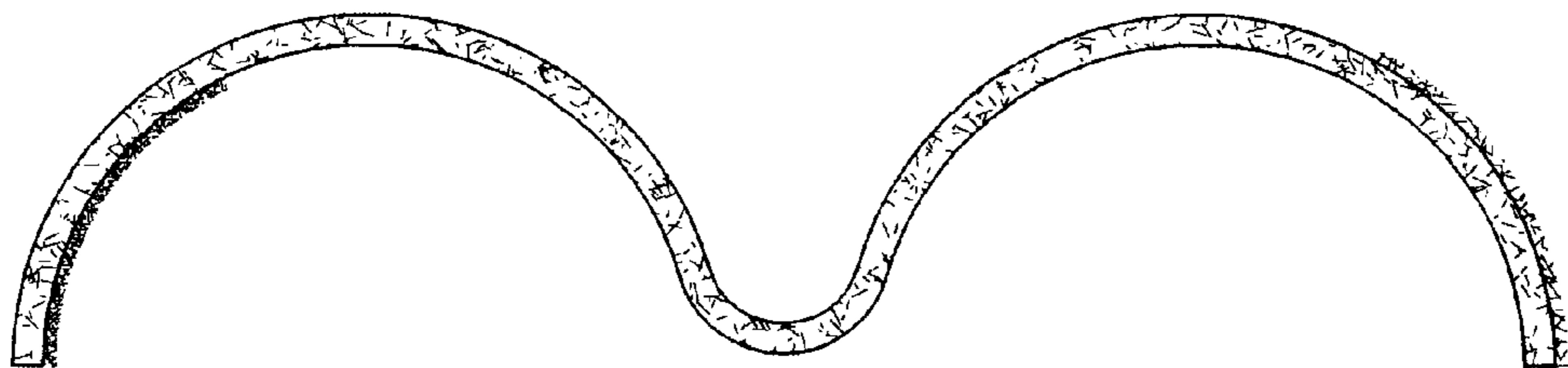
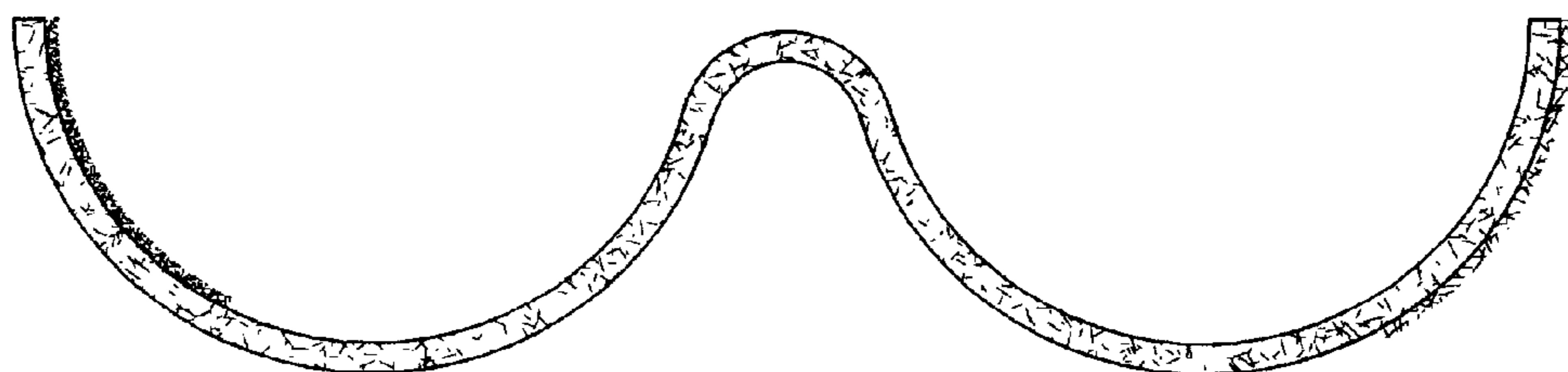

FIG. 6



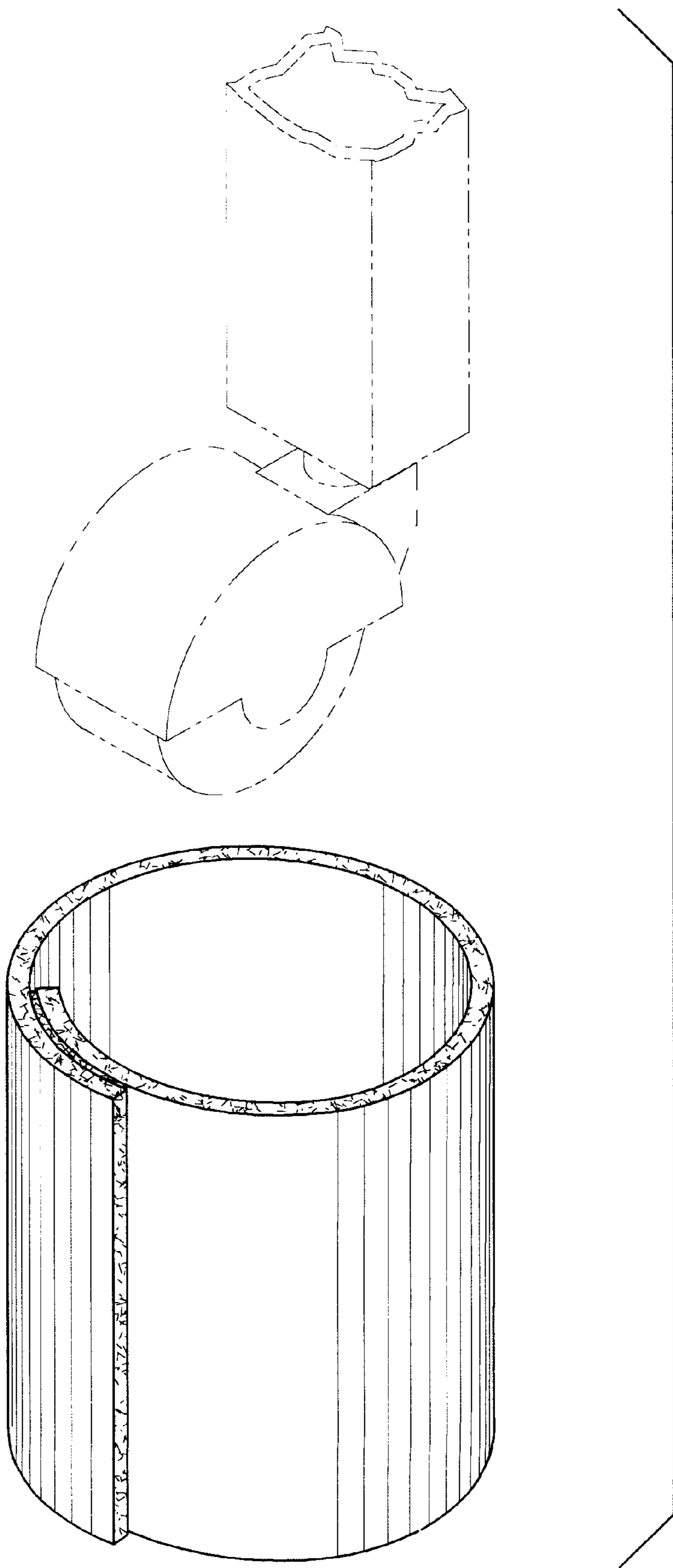

FIG. 7