



US00D432328S

# United States Patent [19]

[11] Patent Number: Des. 432,328

Natuzzi et al.

[45] Date of Patent: \*\* Oct. 24, 2000

[54] SEAT

[75] Inventors: Pasquale Natuzzi; Raffaella Lucarelli, both of Bari, Italy

[73] Assignee: Industrie Natuzzi, SpA, Bari, Italy

[\*\*] Term: 14 Years

[21] Appl. No.: 29/112,353

[22] Filed: Oct. 14, 1999

[51] LOC (7) Cl. .... 06-01

[52] U.S. Cl. .... D6/381; D6/334

[58] Field of Search ..... D6/334, 335, 336, D6/364, 371, 373, 381, 500, 501, 502; 5/12.1; 297/232, 445.1

[56] **References Cited**

**U.S. PATENT DOCUMENTS**

D. 388,259	12/1997	Natuzzi et al.	.....	D6/381
D. 393,759	4/1998	Natuzzi et al.	.....	D6/381
D. 399,355	10/1998	Natuzzi et al.	.....	D6/381
D. 399,359	10/1998	Natuzzi et al.	.....	D6/381
D. 401,431	11/1998	Natuzzi et al.	.....	D6/381
D. 420,525	2/2000	Watson	.....	D6/381

**OTHER PUBLICATIONS**

Natuzzi Model 1716, Sep. 1998, at International Home Furnishings Market in High Point, North Carolina.  
 Natuzzi Model 452, Oct. 1988, at International Home Furnishings Market in High Point, North Carolina.  
 Natuzzi Model 497, Apr. 1989, at International Home Furnishings Market in High Point, North Carolina.  
 Natuzzi Model 664/665, Oct. 1991, at International Home Furnishings Market in High Point, North Carolina.  
 Natuzzi Model 807, Oct. 1989, at International Home Furnishings Market in High Point, North Carolina.  
 Natuzzi Model 814, Oct. 1990, at International Home Furnishings Market in High Point, North Carolina.  
 Natuzzi Model 884, Apr. 1991, at International Home Furnishings Market in High Point, North Carolina.  
 Natuzzi Model 900, Apr. 1992, at International Home Furnishings Market in High Point, North Carolina.

Natuzzi Model 1029, Apr. 1993, at International Home Furnishing Market in High Point, North Carolina.  
 Natuzzi Model 1036, Apr. 1993, at International Home Furnishings Market in High Point, North Carolina.  
 Natuzzi Model 1075, Sep. 1993, at International Home Furnishings Market in High Point, North Carolina.  
 Natuzzi Model 1125, Jan. 1994, at International Home Furnishings Market in High Point, North Carolina.  
 Natuzzi Model 1128, Jan. 1994, at International Home Furnishings Market in High Point, North Carolina.  
 Natuzzi Model 1214, Oct. 1994, at International Home Furnishings Market in High Point, North Carolina.  
 Natuzzi Model 1277, Mar. 1995, at International Home Furnishings Market in High Point, North Carolina.

(List continued on next page.)

Primary Examiner—Gary D. Watson  
Attorney, Agent, or Firm—Alston & Bird LLP

[57] **CLAIM**

The ornamental design for a seat, as shown and described.

**DESCRIPTION**

FIG. 1 is a front perspective view of a seat showing our new design in the form of a sofa;  
 FIG. 2 is a front elevational view thereof;  
 FIG. 3 is a top plan view thereof;  
 FIG. 4 is a right side elevational view, the left side being a mirror image thereof;  
 FIG. 5 is a rear perspective view thereof;  
 FIG. 6 is a front elevational view of a seat showing our new design in the form of a loveseat; and,  
 FIG. 7 is a front elevational view of a seat showing our new design in the form of a chair.  
 The broken lines shown herein are for illustrative purposes only and form no part of the claimed design.  
 The rear views of FIGS. 6 and 7 are like FIG. 5, the difference being a matter of length.  
 The end views of FIGS. 6 and 7 are like FIG. 4.  
 FIG. 1 is shown on an enlarged scale and FIGS. 4 and 5 are shown on a reduced scale with respect to the other views.

1 Claim, 3 Drawing Sheets

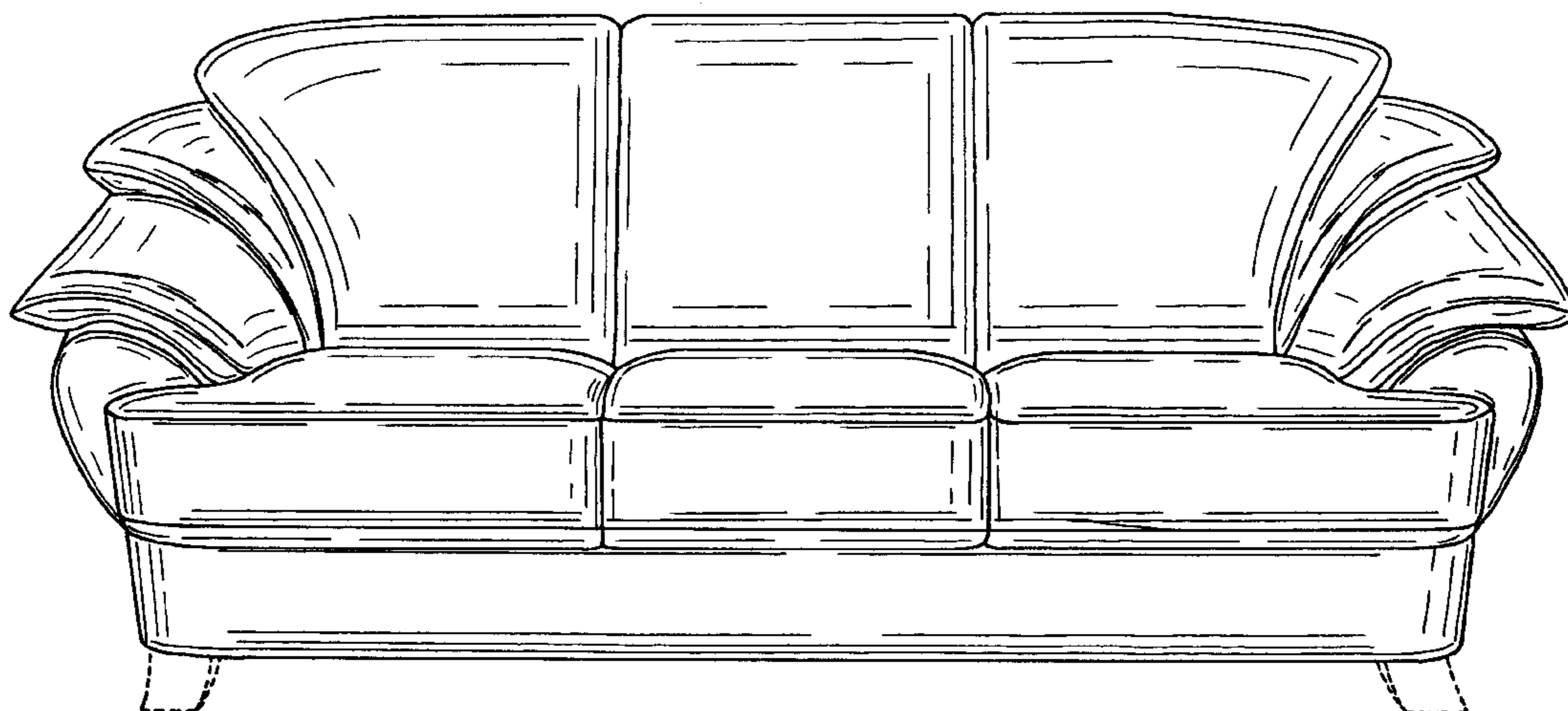

OTHER PUBLICATIONS

Natuzzi Model 1382, Oct. 1995, at International Home Furnishings Market in High Point, North Carolina.

Natuzzi Model 1396, Oct. 1995, at International Home Furnishings Market in High Point, North Carolina.

Natuzzi Model 1400, Mar. 1996, at International Home Furnishings Market in High Point, North Carolina.

Natuzzi Model 1486, Sep. 1996, at International Home Furnishings Market in High Point, North Carolina.

Natuzzi Model 1518, Oct. 1996, at International Home Furnishings Market in High Point, North Carolina.

Natuzzi Model 1595, Apr. 1997, at International Home Furnishings Market in High Point, North Carolina.

Natuzzi Model 1717, Sep. 1998, at International Home Furnishing Market in High Point, North Carolina.

Natuzzi Model 1726, Sep. 1998, at International Home Furnishings Market in High Point, North Carolina.

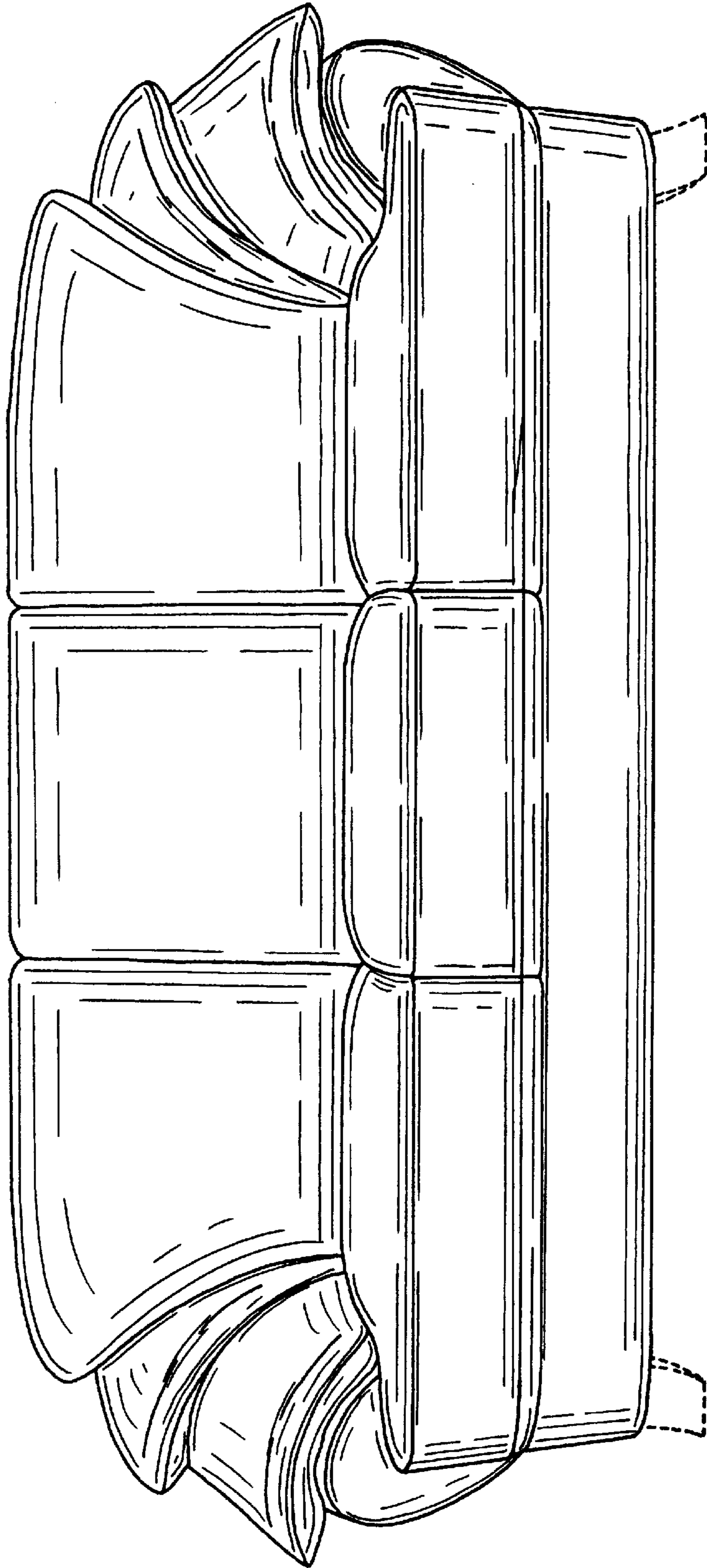

FIG. 1.

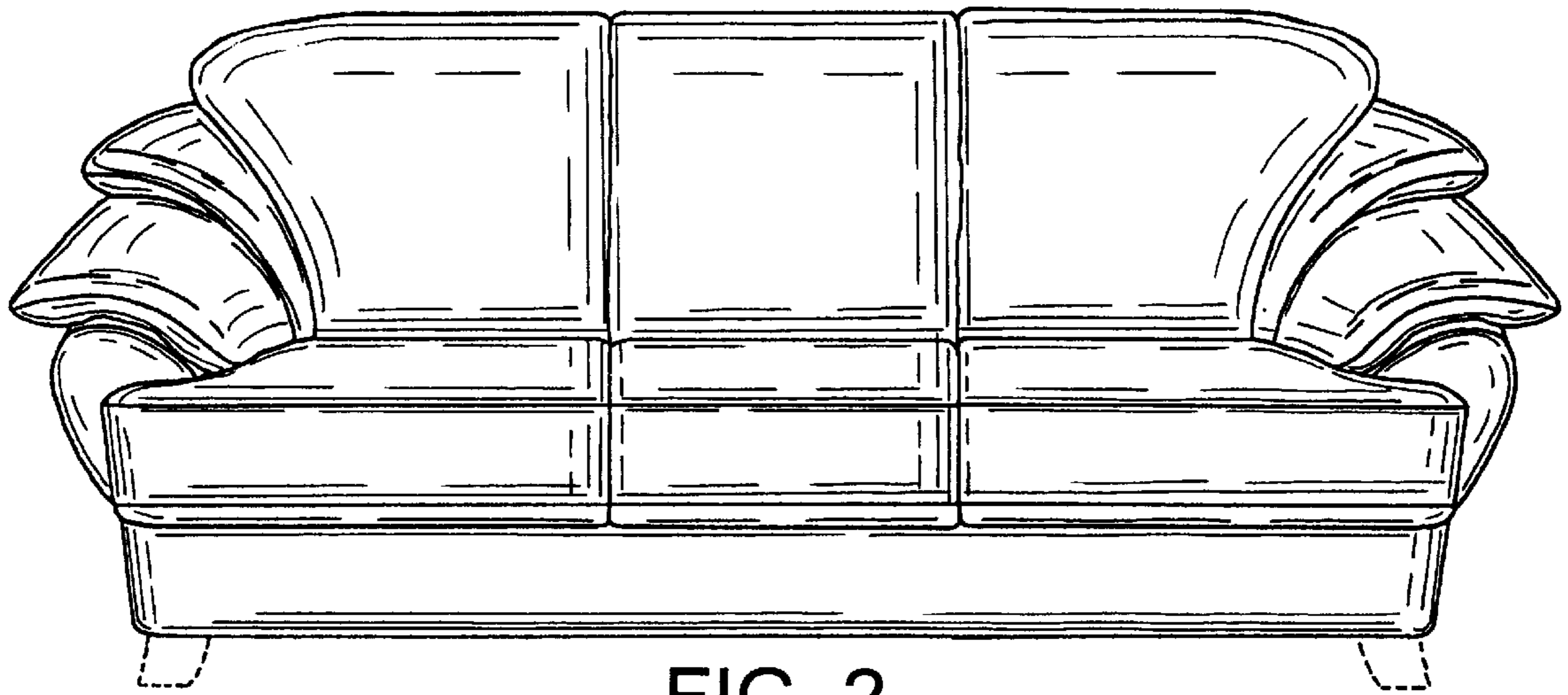

FIG. 2.

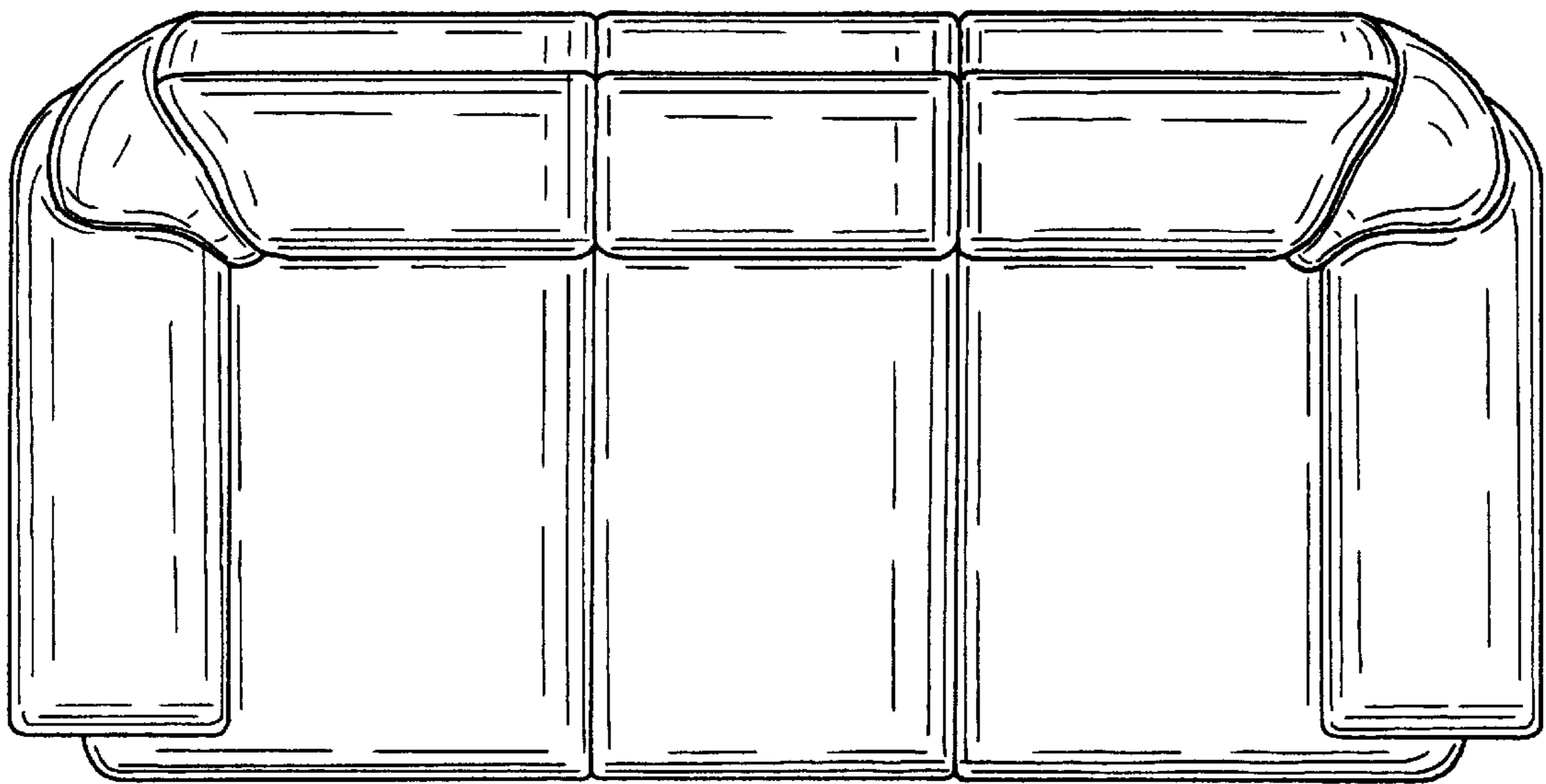

FIG. 3.

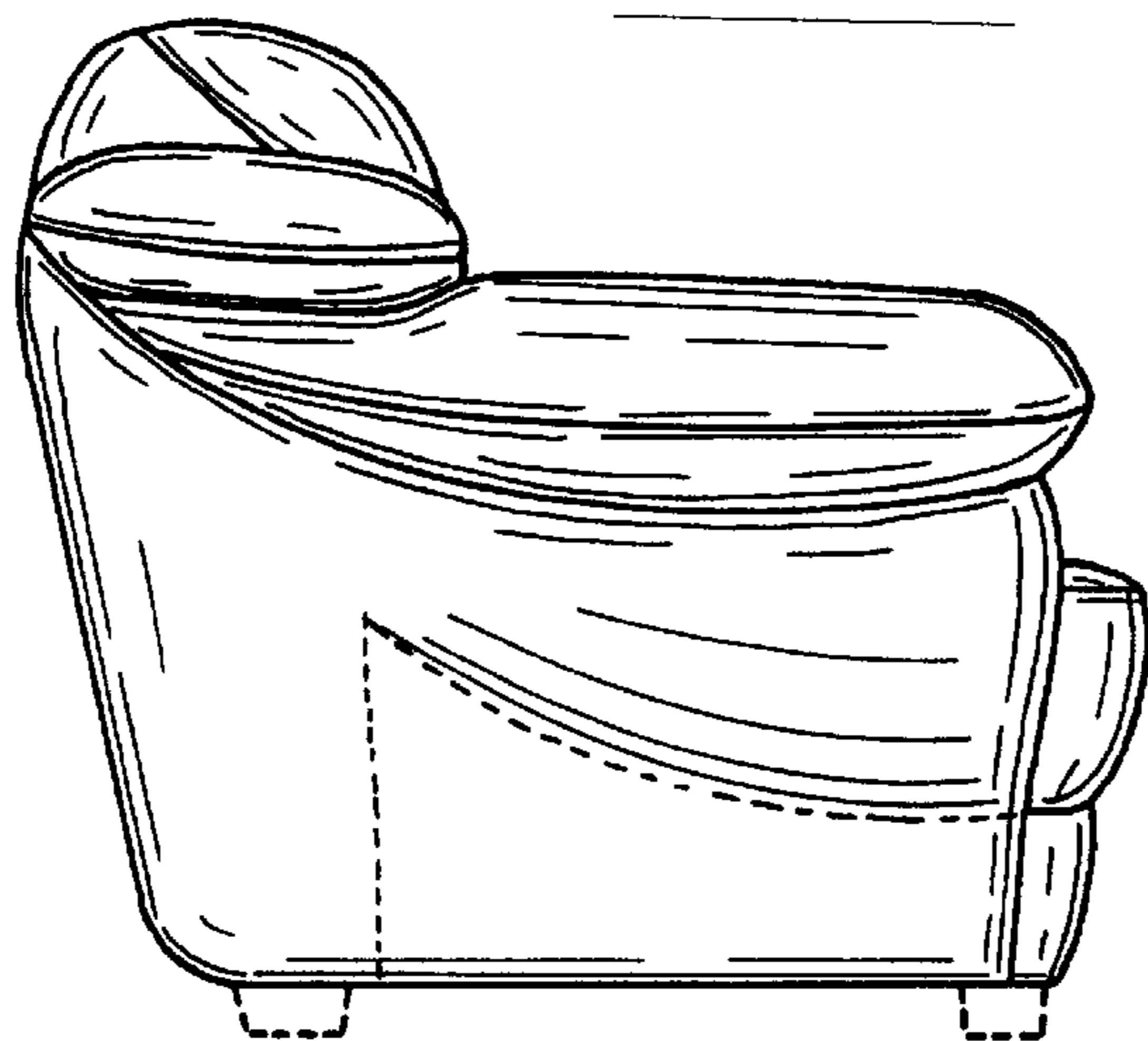

FIG. 4.

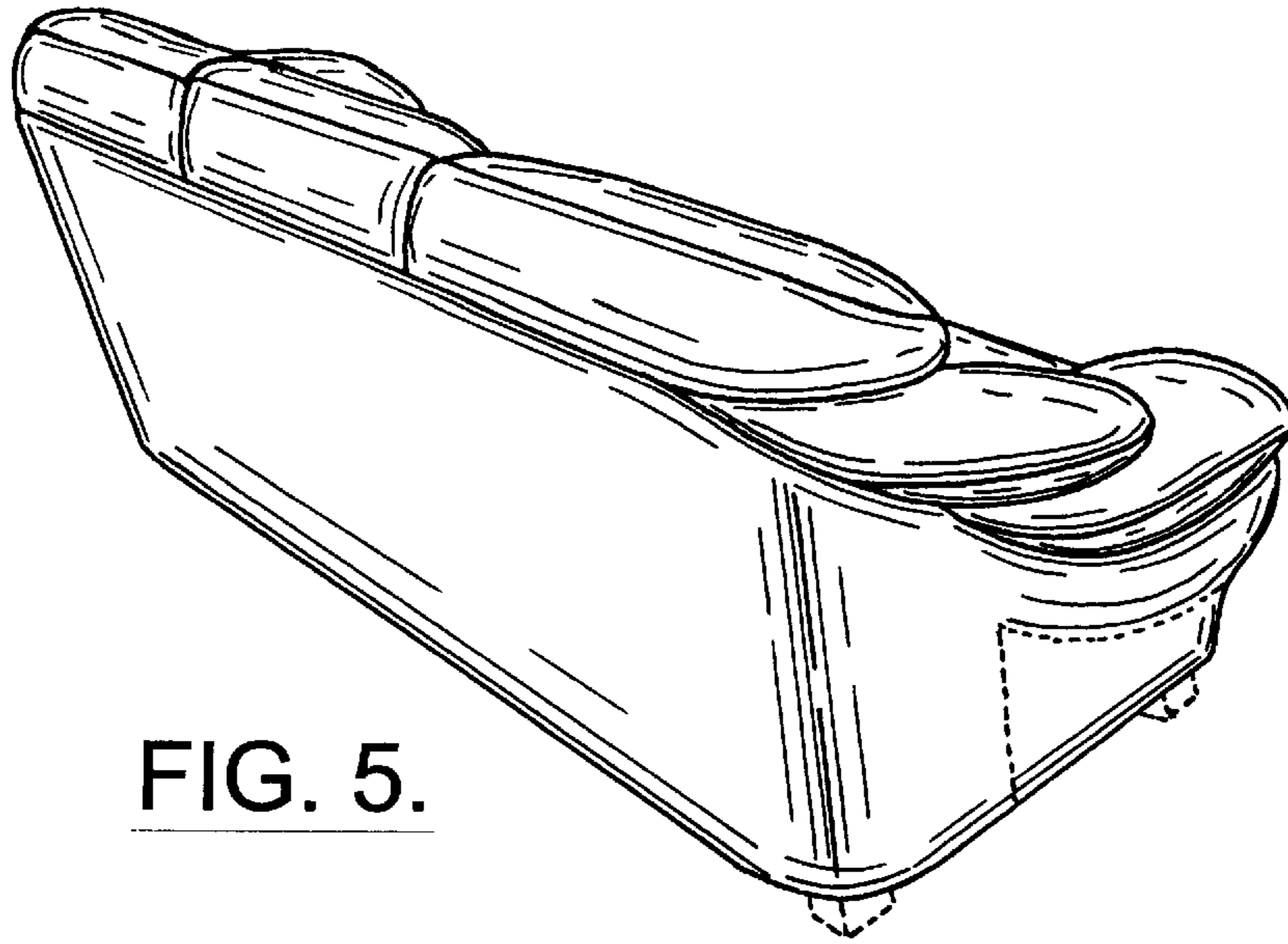

FIG. 5.

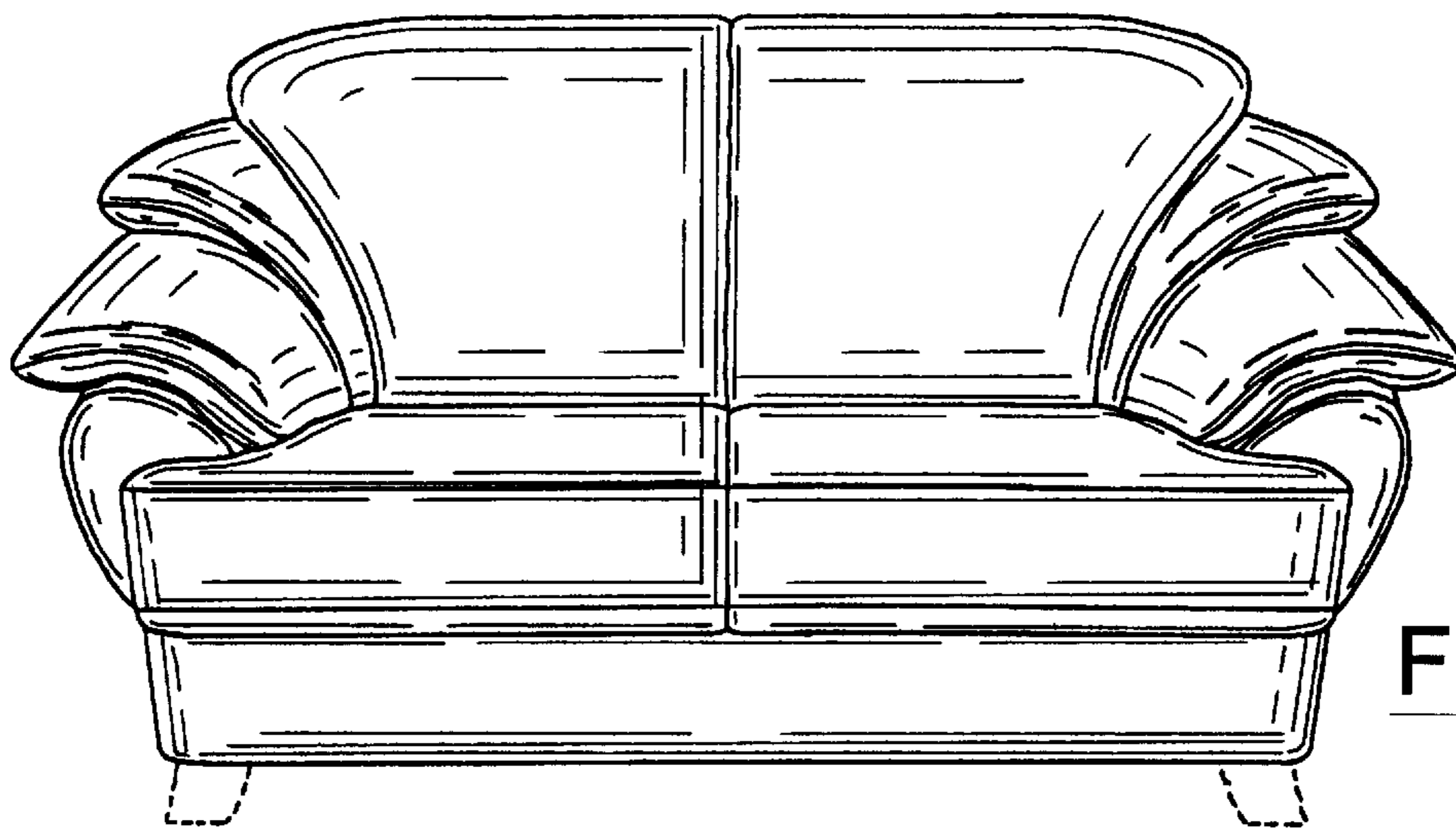

FIG. 6.

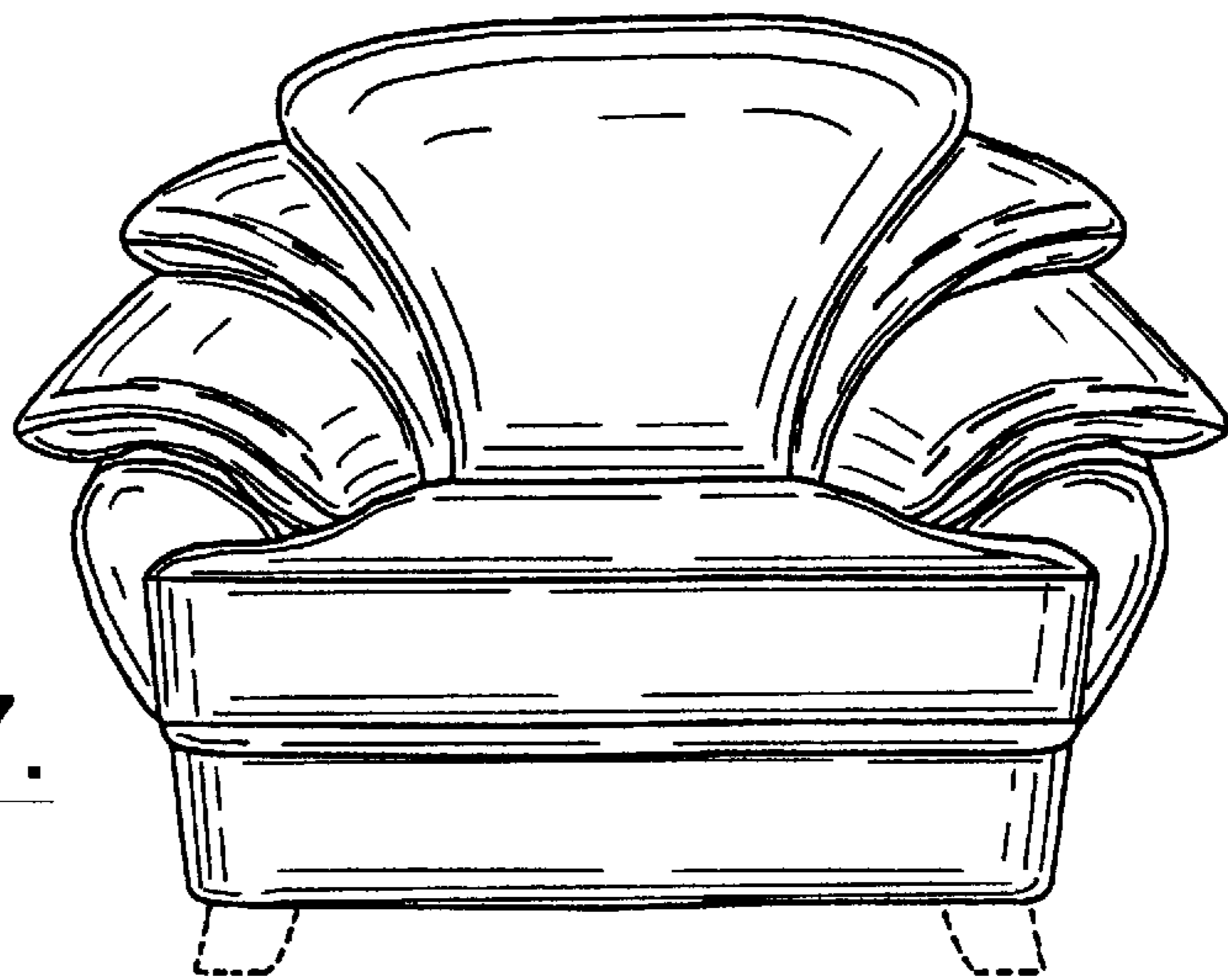

FIG. 7.