



US00D432327S

# United States Patent [19]

[11] **Patent Number: Des. 432,327**

**Natuzzi et al.**

[45] **Date of Patent: \*\* Oct. 24, 2000**

[54] **SEAT**

[75] Inventors: **Pasquale Natuzzi, Bari; Arcangelo Scarati, Taranto, both of Italy**

[73] Assignee: **Industrie Natuzzi, SpA**

[\*\*] Term: **14 Years**

[21] Appl. No.: **29/110,563**

[22] Filed: **Sep. 9, 1999**

[51] **LOC (7) Cl. .... 06-01**

[52] **U.S. Cl. .... D6/381; D6/334**

[58] **Field of Search ..... D6/334, 335, 336, D6/364, 371, 373, 381, 500, 501, 502; 5/12.1; 297/232, 445.1**

## [56] **References Cited**

### U.S. PATENT DOCUMENTS

D. 362,979	10/1995	Natuzzi et al. ....	D6/381
D. 393,759	4/1998	Natuzzi et al. ....	D6/381
D. 400,368	11/1998	Natuzzi et al. ....	D6/381
D. 401,431	11/1998	Natuzzi et al. ....	D6/381
D. 407,573	4/1999	Natuzzi et al. ....	D6/381
D. 418,994	1/2000	Natuzzi et al. ....	D6/381
D. 419,328	1/2000	Natuzzi et al. ....	D6/381
D. 420,525	2/2000	Watson .....	D6/381
D. 420,829	2/2000	Natuzzi et al. ....	D6/381
D. 421,193	2/2000	Natuzzi et al. ....	D6/381
D. 424,318	5/2000	Natuzzi et al. ....	D6/381
D. 424,319	5/2000	Natuzzi et al. ....	D6/381

### OTHER PUBLICATIONS

Natuzzi Model 152, at least as early as 1987, at International Home Furnishings Market in High Point, North Carolina.  
 Natuzzi Model 167, at least as early as Apr. 1986, at International Home Furnishings Market in High Point, North Carolina.  
 Natuzzi Model 404, Oct. 1987, at International Home Furnishings Market in High Point, North Carolina.  
 Natuzzi Model 417, Oct. 1987, at International Home Furnishings Market in High Point, North Carolina.

Natuzzi Model 487, Apr. 1989, at International Home Furnishings Market in High Point, North Carolina.  
 Natuzzi Model 619, Oct. 1988, at International Home Furnishings Market in High Point, North Carolina.  
 Natuzzi Model 621, Oct. 1988, at International Home Furnishings Market in High Point, North Carolina.  
 Natuzzi Model 733, Nov. 1989, at International Home Furnishing Market in High Point, North Carolina.  
 Natuzzi Model 736, Apr. 1990, at International Home Furnishings Market in High Point, North Carolina.  
 Natuzzi Model 742, Apr. 1990, at International Home Furnishings Market in High Point, North Carolina.

(List continued on next page.)

*Primary Examiner*—Gary D. Watson  
*Attorney, Agent, or Firm*—Alston & Bird LLP

## [57] **CLAIM**

The ornamental design for a seat, as shown and described.

### **DESCRIPTION**

FIG. 1 is a front perspective view of a seat showing our new design in the form of a sofa;  
 FIG. 2 is a front elevational view thereof;  
 FIG. 3 is a top plan view thereof;  
 FIG. 4 is a right side elevational view, the left side being a mirror image thereof;  
 FIG. 5 is a rear perspective view thereof;  
 FIG. 6 is a front elevational view of a seat showing our new design in the form of a loveseat; and,  
 FIG. 7 is a front elevational view of a seat showing our new design in the form of a chair.  
 The rear views of FIGS. 6 and 7 are like FIG. 5, the difference being a matter of length.  
 The end views of FIGS. 6 and 7 are like FIG. 4.  
 FIGS. 2, 3, 6 and 7 have been shown on a smaller scale with respect to FIG. 1 and FIGS. 4 and 5 have been shown on yet a smaller scale.

**1 Claim, 3 Drawing Sheets**

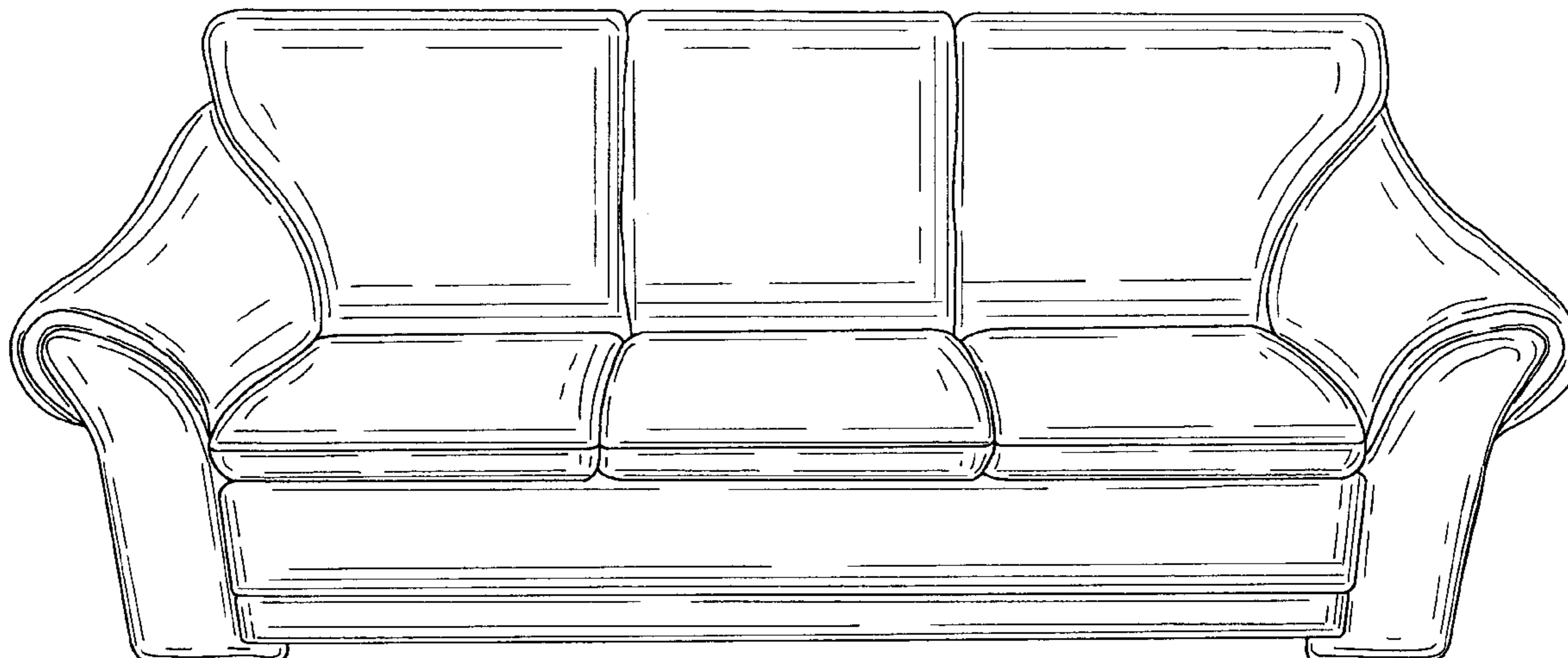

OTHER PUBLICATIONS

Natuzzi Model 841, Apr. 1991, at International Home Furnishings Market in High Point, North Carolina.  
Natuzzi Model 899, Apr. 1992, at International Home Furnishings Market in High Point, North Carolina.  
Natuzzi Model 1010, Apr. 1993, at International Home Furnishings Market in High Point, North Carolina.  
Natuzzi Model 1023, Apr. 1993, at International Home Furnishings Market in High Point, North Carolina.  
Natuzzi Model 1069, Oct. 1993, at International Home Furnishings Market in High Point, North Carolina.  
Natuzzi Model 1107, Oct. 1993, at International Home Furnishings Market in High Point, North Carolina.  
Natuzzi Model 1109, Oct. 1993, at International Home Furnishings Market in High Point, North Carolina.  
Natuzzi Model 1125, Jan. 1994, at International Home Furnishings Market in High Point, North Carolina.  
Natuzzi Model 1137, Apr. 1994, at International Home Furnishings Market in High Point, North Carolina.  
Natuzzi Model 1226, Oct. 1994, at International Home Furnishings Market in High Point, North Carolina.  
Natuzzi Model 1294, Mar. 1995, at International Home Furnishings Market in High Point, North Carolina.  
Natuzzi Model 1455, Apr. 1996, at International Home Furnishings Market in High Point, North Carolina.  
Natuzzi Model 1483, Oct. 1996, at International Home Furnishings Market in High Point, North Carolina.  
Natuzzi Model 1502, Oct. 1996, at International Home Furnishings Market in High Point, North Carolina.

Natuzzi Model 1516, Oct. 1996, at International Home Furnishings Market in High Point, North Carolina.  
Natuzzi Model 1526, Oct. 1996, at International Home Furnishings Market in High Point, North Carolina.  
Natuzzi Model 1545, Oct. 1996, at International Home Furnishings Market in High Point, North Carolina.  
Natuzzi Model 1548, Oct. 1996, at International Home Furnishings Market in High Point, North Carolina.  
Natuzzi Model 1558, Apr. 1997, at International Home Furnishings Market in High Point, North Carolina.  
Natuzzi Model 1563, Apr. 1997, at International Home Furnishings Market in High Point, North Carolina.  
Natuzzi Model 1582, Apr. 1997, at International Home Furnishings Market in High Point, North Carolina.  
Natuzzi Model 1584, Apr. 1997, at International Home Furnishings Market in High Point, North Carolina.  
Natuzzi Model 1594, Apr. 1997, at International Home Furnishings Market in High Point, North Carolina.  
Natuzzi Model 1604, Apr. 1997, at International Home Furnishings Market in High Point, North Carolina.  
Natuzzi Model 1678, Apr. 1998, at International Home Furnishings Market in High Point, North Carolina.  
Natuzzi Model 1690, Apr. 1998, at International Home Furnishings Market in High Point, North Carolina.  
Natuzzi Model R525, Apr. 1998, at International Home Furnishings Market in High Point, North Carolina.

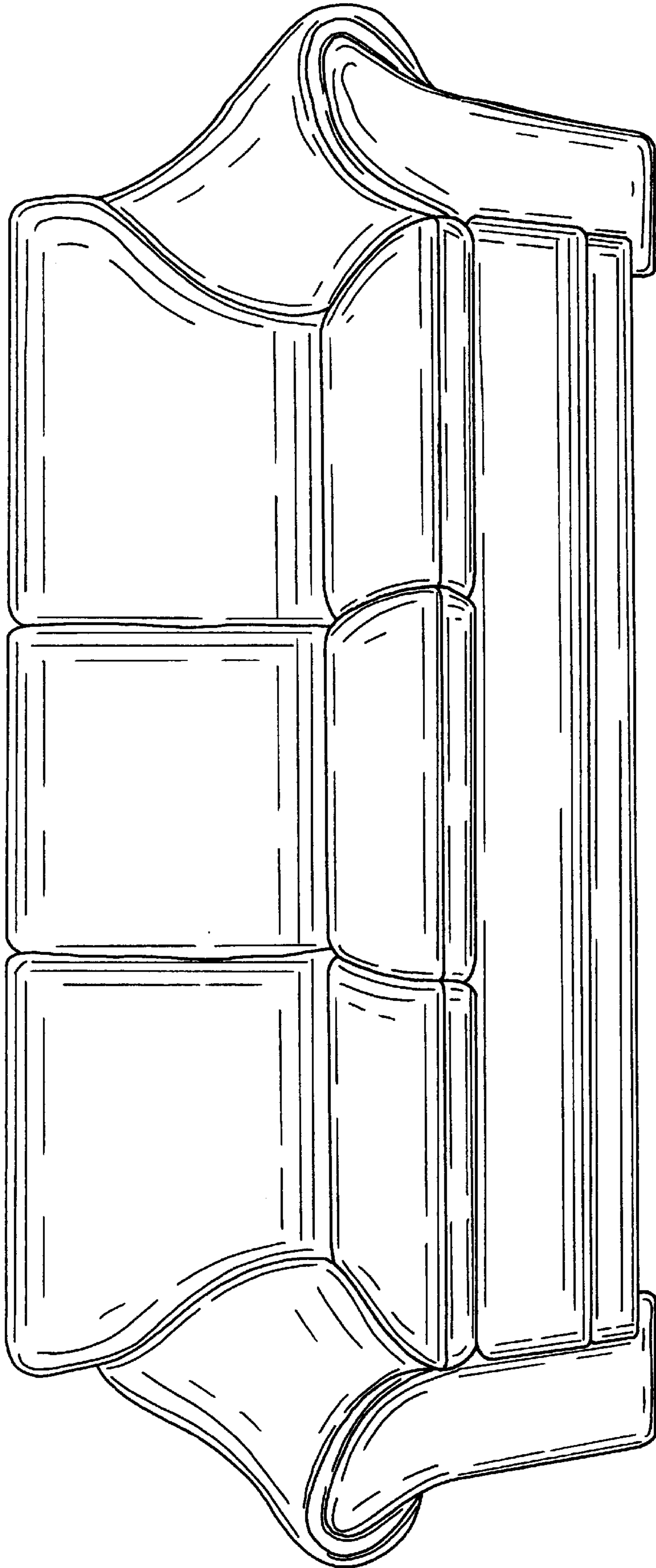

FIG. 1.



FIG. 2.

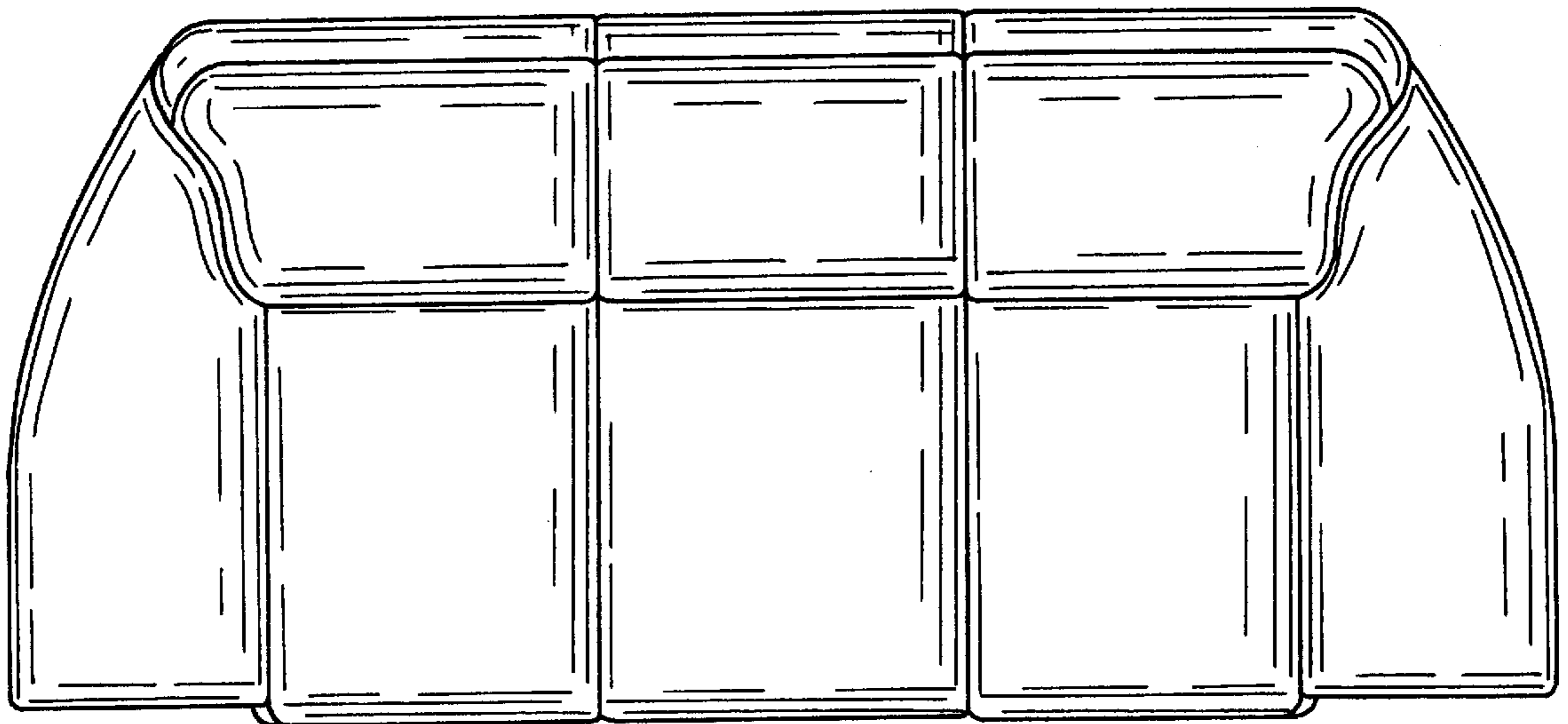

FIG. 3.

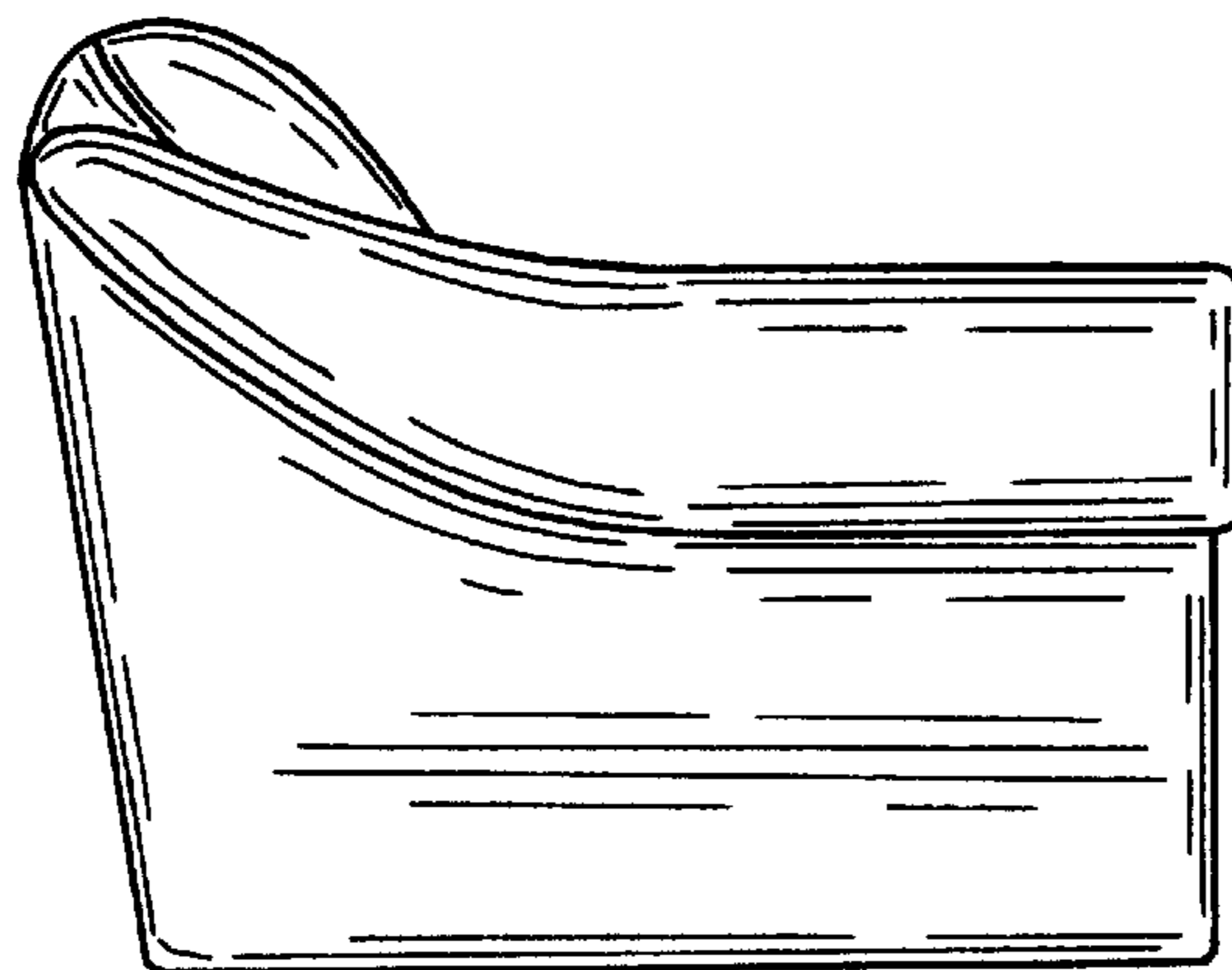

FIG. 4.

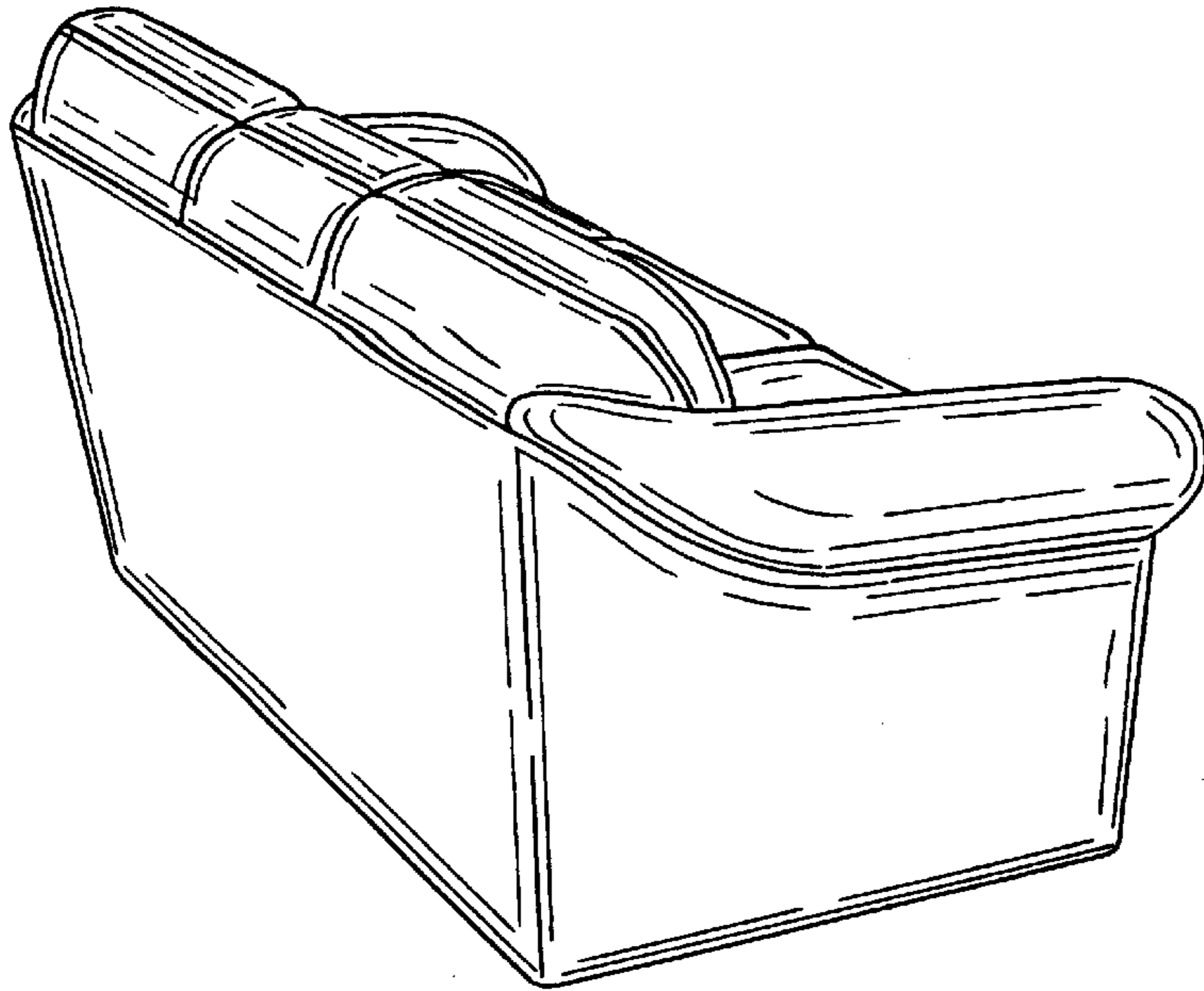

FIG. 5.

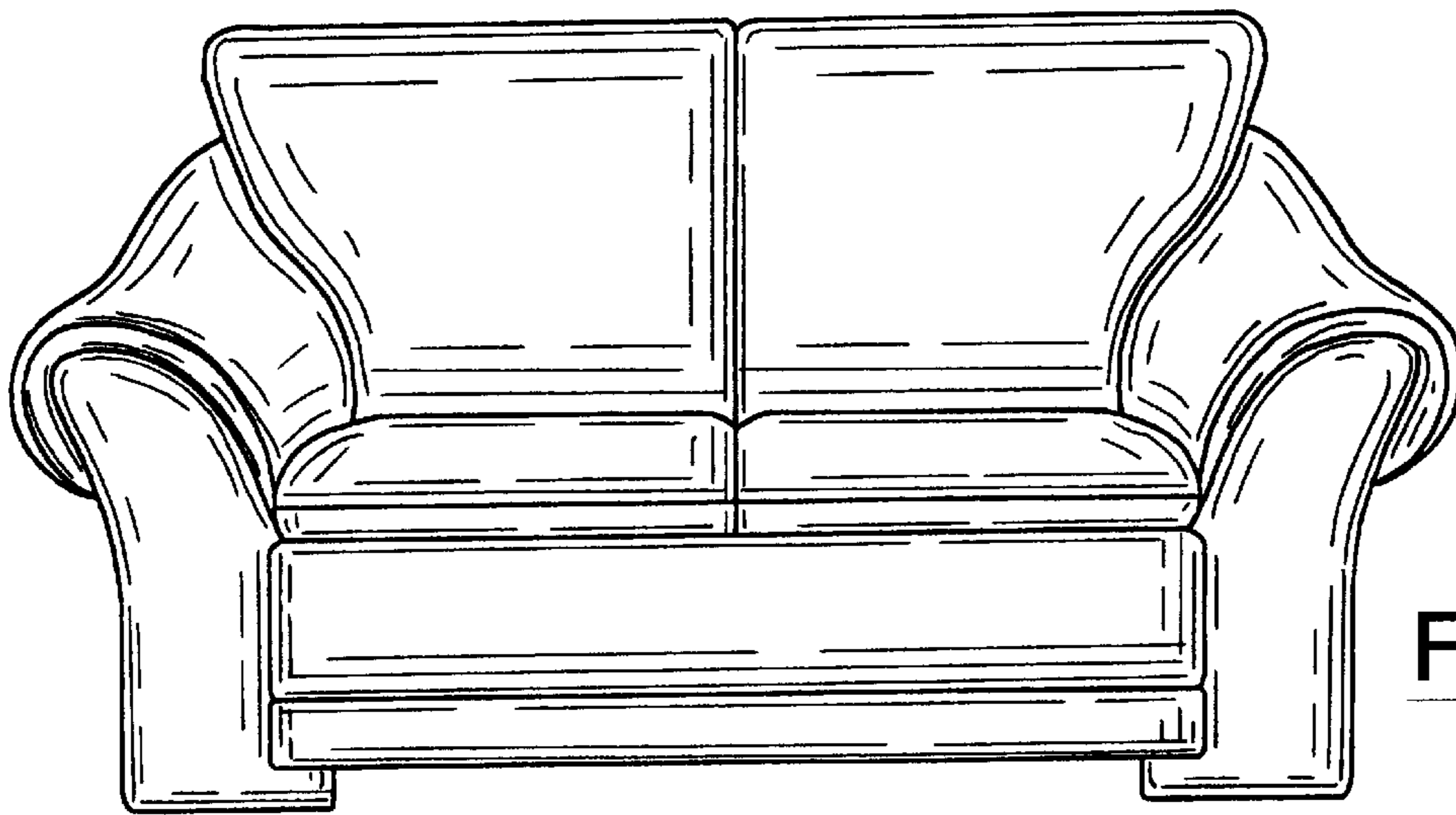

FIG. 6.

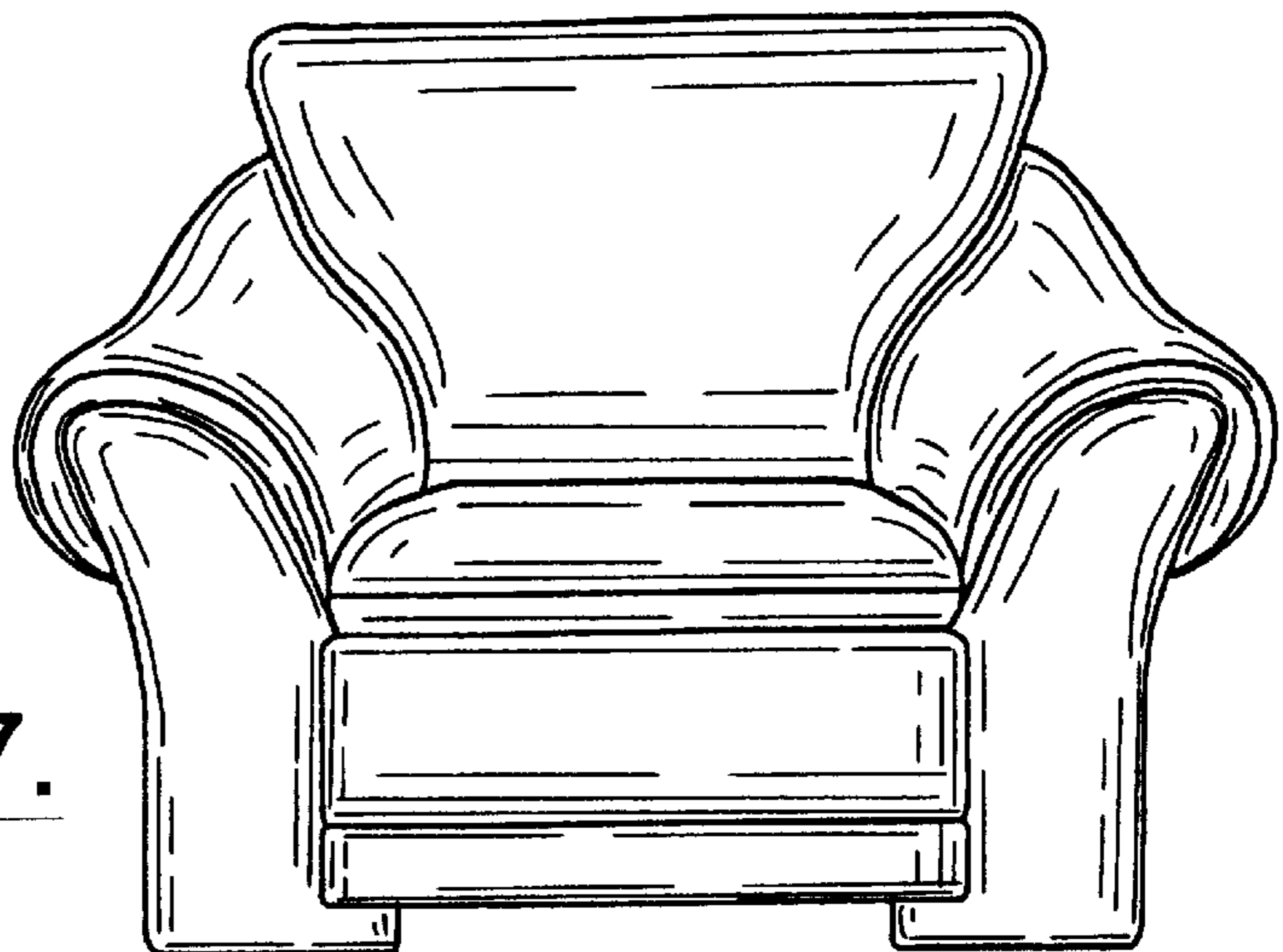

FIG. 7.