



US00D432316S

United States Patent [19] Duggan

[11] **Patent Number: Des. 432,316**

[45] **Date of Patent: ** Oct. 24, 2000**

[54] **ROBE HOOK**

[75] Inventor: **Michael P. Duggan**, Brookside, N.J.

[73] Assignee: **Melard Manufacturing Corp.**, Passaic, N.J.

[**] Term: **14 Years**

[21] Appl. No.: **29/106,839**

[22] Filed: **Jun. 22, 1999**

[51] **LOC (7) Cl.** **06-08**

[52] **U.S. Cl.** **D6/317; D6/323; D6/566; D8/370; D8/372**

[58] **Field of Search** **D6/315, 320, 323, D6/566, 569, 572; D8/367, 370, 372; 248/303, 304, 220.41; 211/86.01, 87.01, 106, 106.01**

[56] **References Cited**

U.S. PATENT DOCUMENTS

D. 283,786	5/1986	Chap	D8/372
D. 300,804	4/1989	Myers	D8/367
D. 387,569	12/1997	Goodman et al.	D6/323

OTHER PUBLICATIONS

HEWI—Hooks & Coat Hangers; p. 2; Double Hook 526, ©1989.

Meyer Hook brochure; p. 3; Horse Shoe Hook #336. Architectural Supplements, Inc.; p. 4; hook 54570.

Primary Examiner—B. J. Bullock

Attorney, Agent, or Firm—Edgar A. Zarins; Lloyd D. Doigan

[57] **CLAIM**

The ornamental design for a robe hook, as shown and described.

DESCRIPTION

FIG. 1 is a perspective view of a robe hook showing my new design;

FIG. 2 is a front elevational view thereof;

FIG. 3 is a rear elevational view thereof;

FIG. 4 is a left side view thereof, the opposite side being a mirror image of the side shown;

FIG. 5 is a top plan view thereof; and,

FIG. 6 is a bottom plan view thereof.

1 Claim, 3 Drawing Sheets

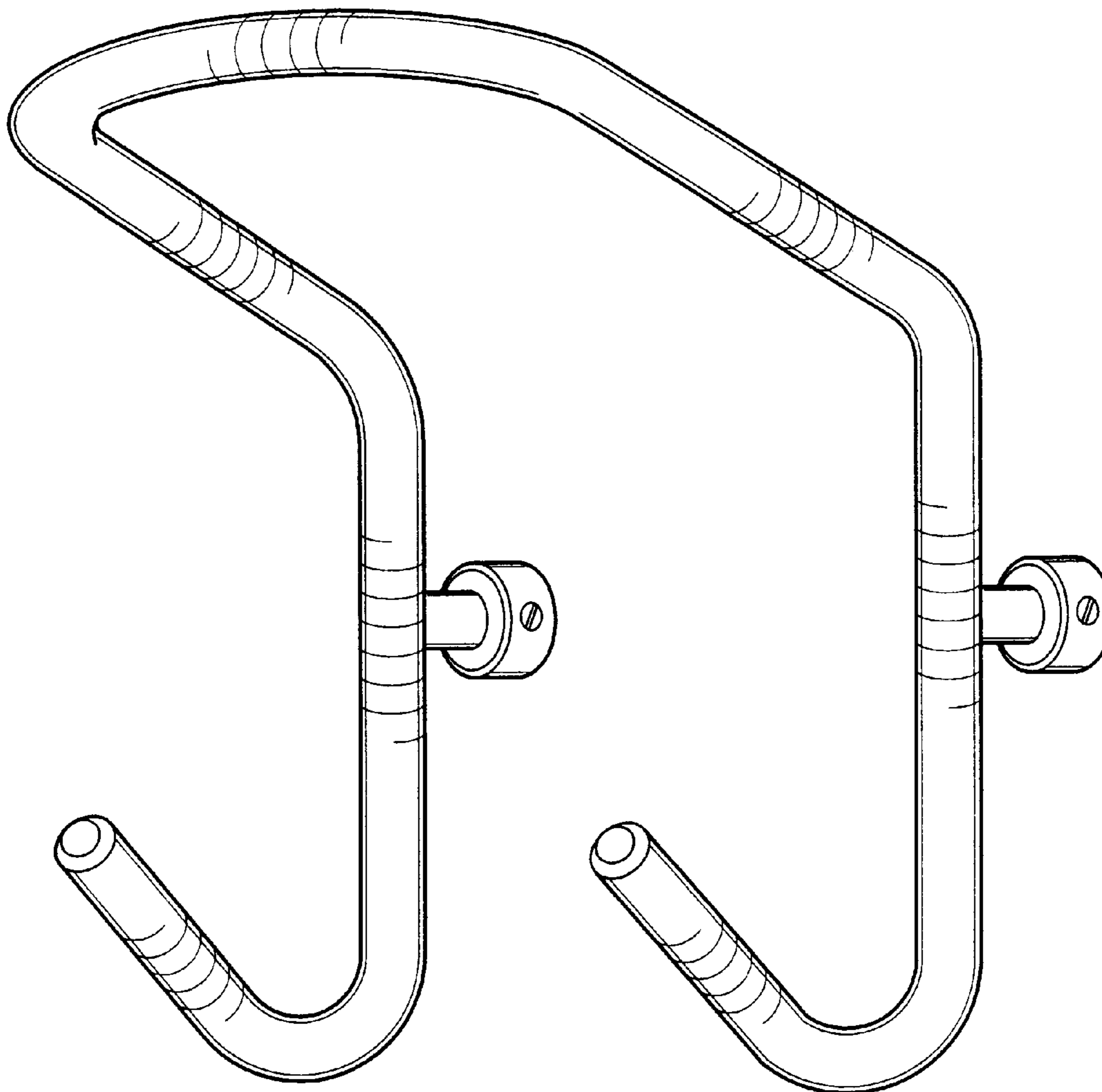

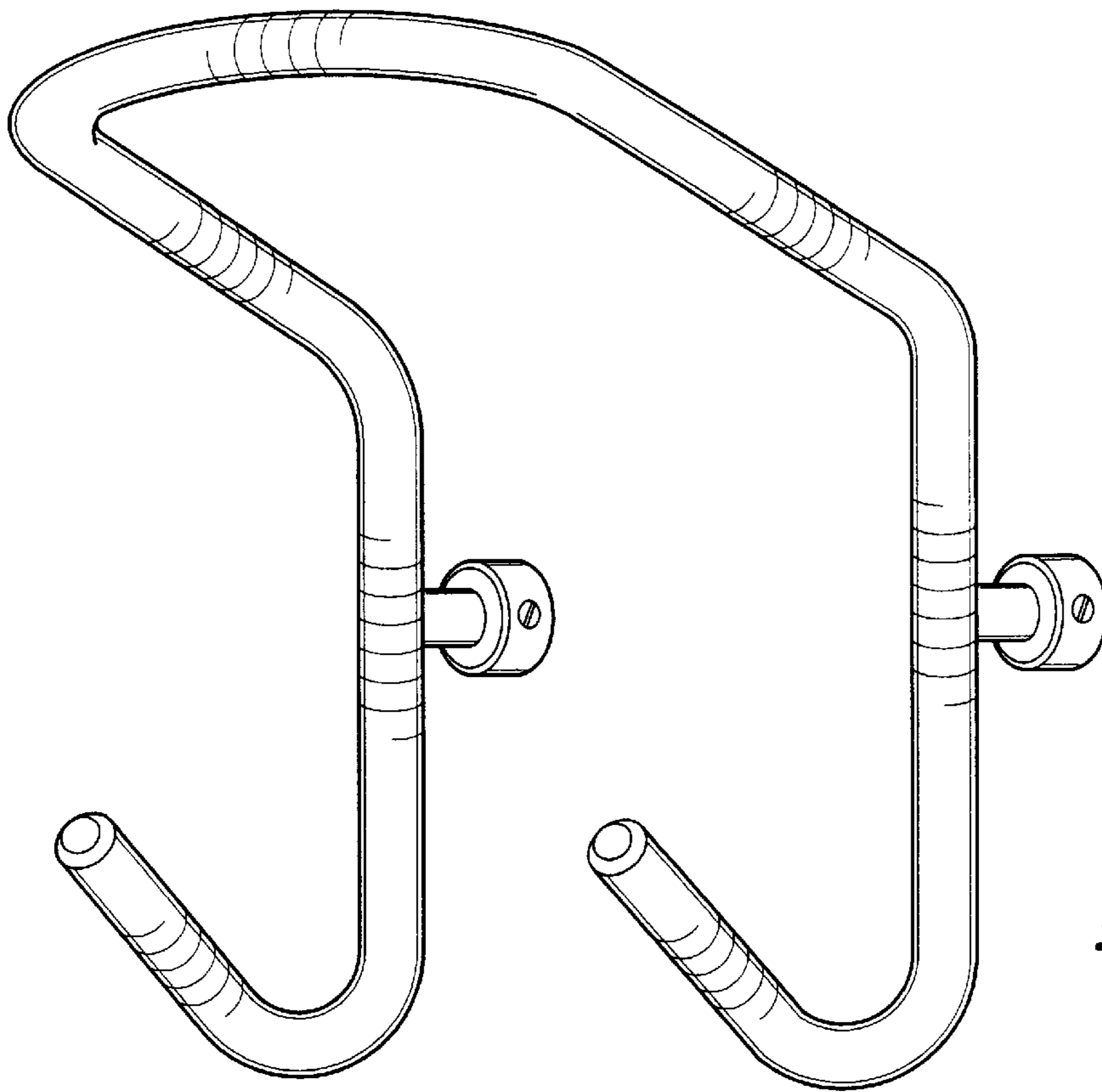

Fig-1

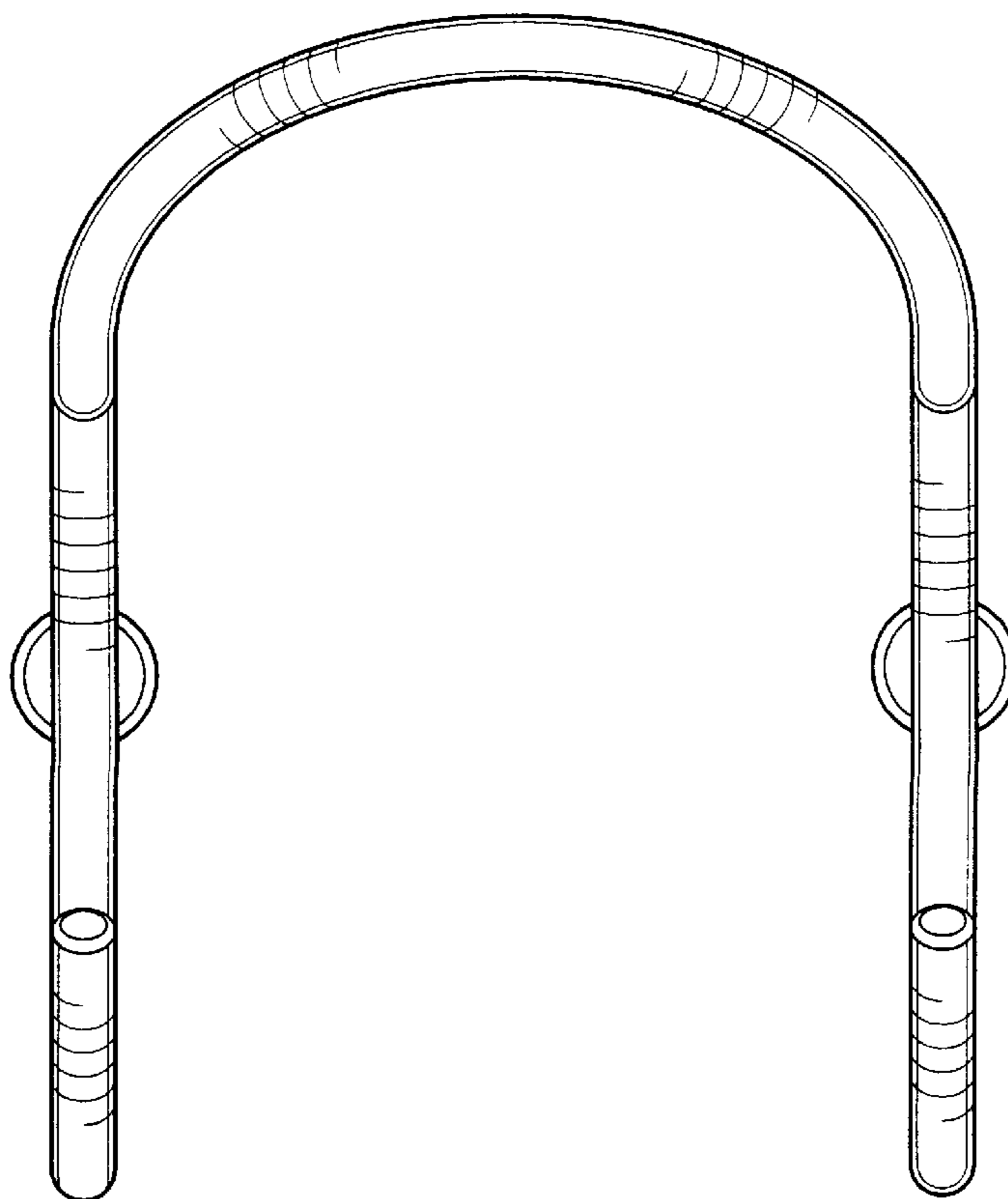

Fig-2

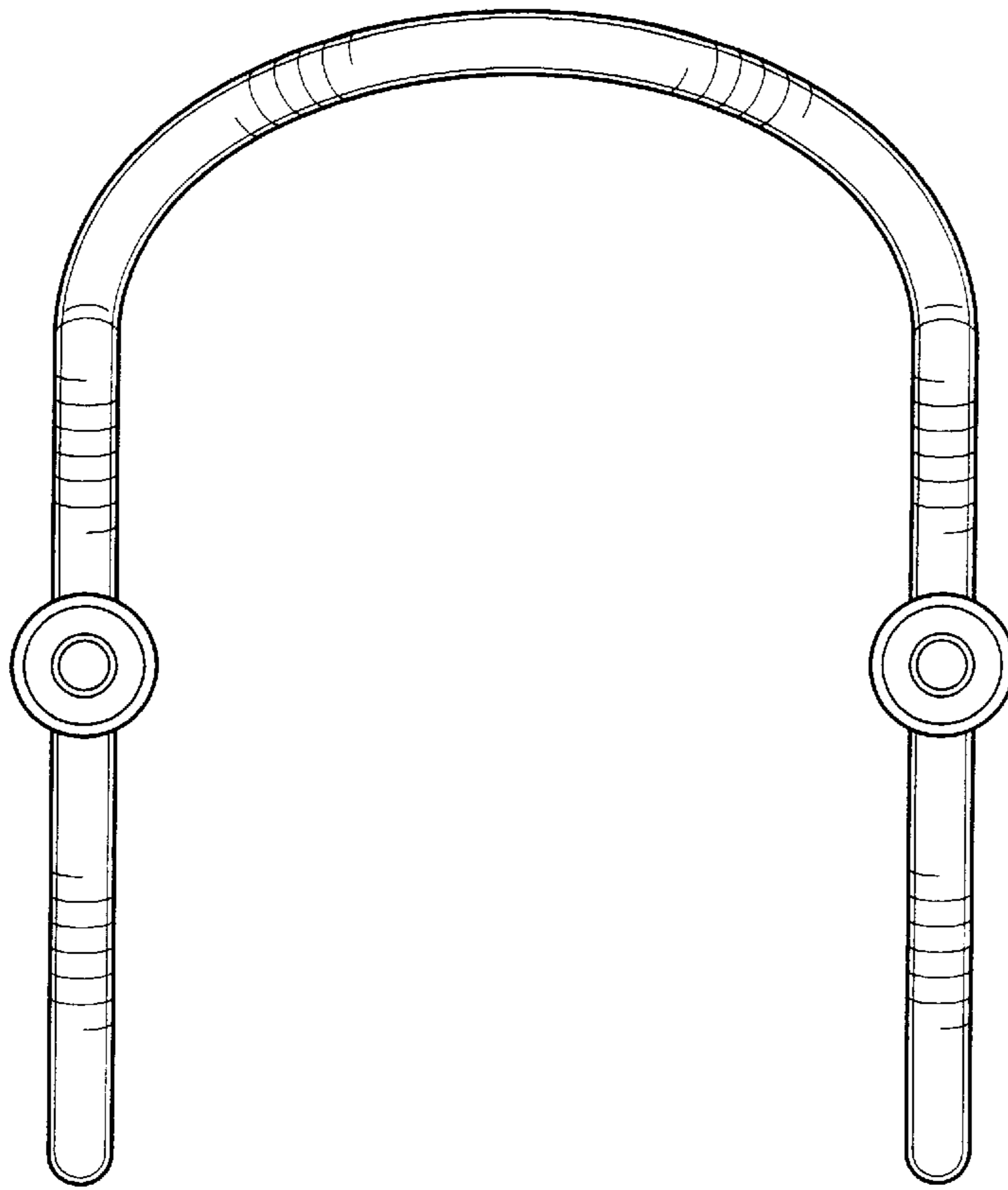

Fig-3

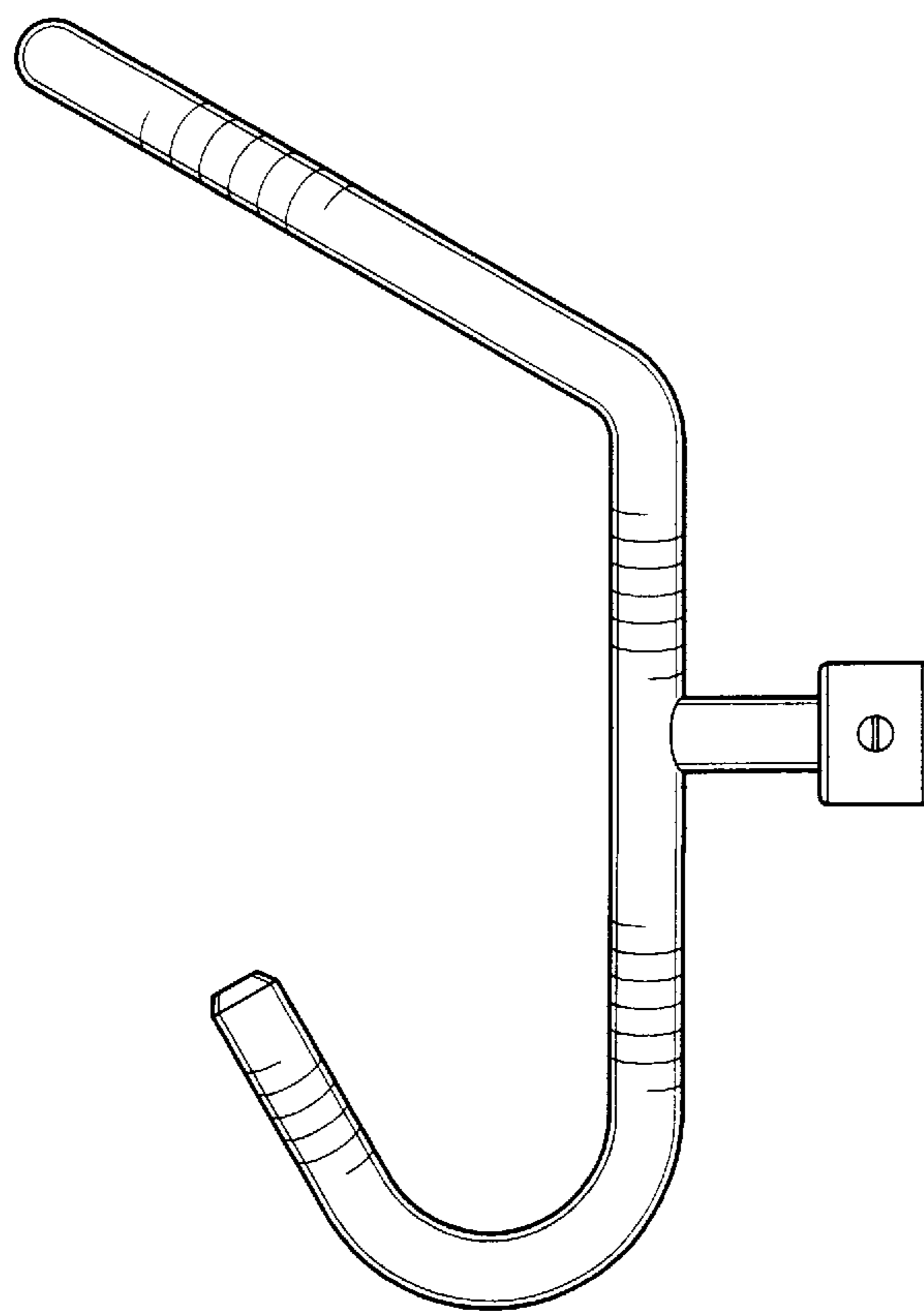

Fig-4

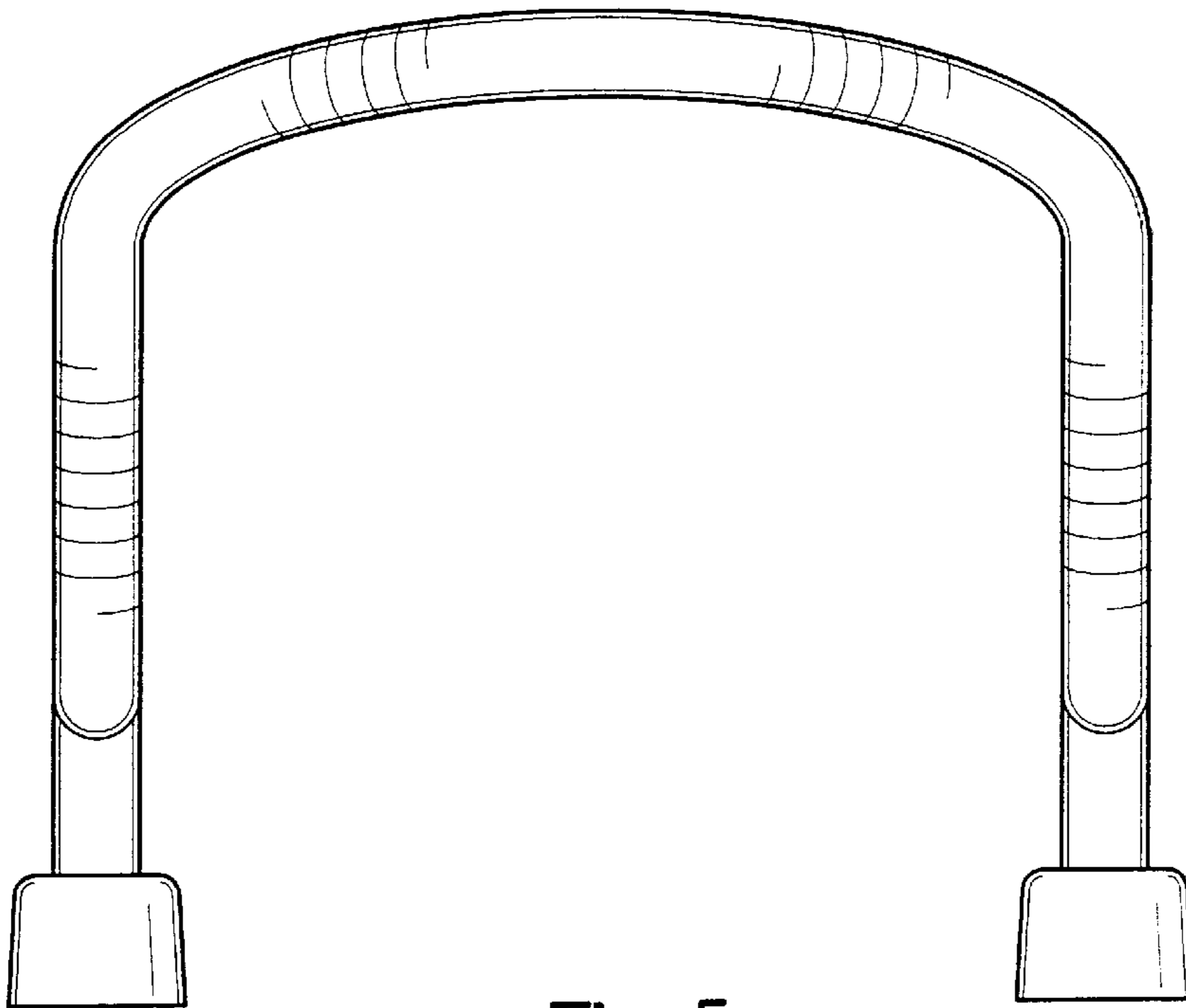

Fig-5

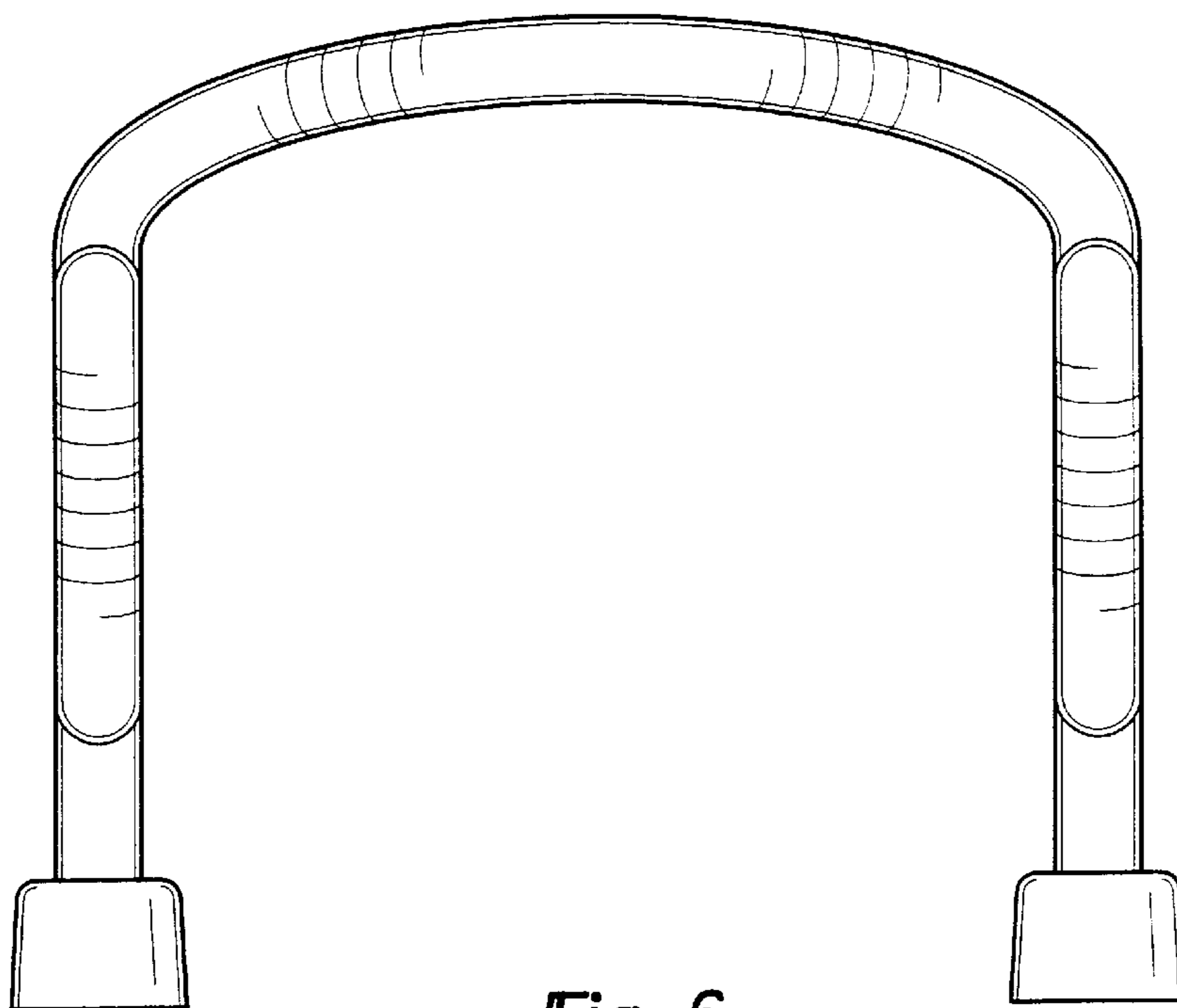

Fig-6