



US00D432242S

United States Patent [19] Lie

[11] **Patent Number: Des. 432,242**

[45] **Date of Patent: ** Oct. 17, 2000**

[54] **MASSAGER**

[75] **Inventor: Sen-Nen Lie**, Kowloon, The Hong Kong Special Administrative Region of the People's Republic of China

[73] **Assignee: Kolvin Industries Limited**, Kowloon, The Hong Kong Special Administrative Region of the People's Republic of China

[**] **Term: 14 Years**

[21] **Appl. No.: 29/114,888**

[22] **Filed: Dec. 2, 1999**

[30] **Foreign Application Priority Data**

Sep. 14, 1999 [HK] The Hong Kong Special Administrative Region of the People's Republic of China 9911226

[51] **LOC (7) Cl. 28-03**

[52] **U.S. Cl. D24/212**

[58] **Field of Search D24/212, 213, D24/215, 200; 601/46, 27, 28, 29, 30, 61, 56**

[56] **References Cited**

U.S. PATENT DOCUMENTS

D. 186,488	10/1959	Madl	D24/212
D. 234,828	4/1975	McNair	D24/212
D. 269,636	7/1983	MacGregor et al.	D24/212
D. 411,304	6/1999	Yang	D24/212
3,043,294	7/1962	Neff	601/61
3,830,232	8/1974	McNair	601/64

Primary Examiner—Stella Reid
Attorney, Agent, or Firm—Merchant & Gould P.C.

[57] **CLAIM**

The ornamental design for a massager, as shown and described.

DESCRIPTION

FIG. 1 is a front elevational view of a massager, showing my new design;
FIG. 2 is a rear elevational view thereof;
FIG. 3 is a top elevational view thereof;
FIG. 4 is a bottom elevational view thereof;
FIG. 5 is a left side elevational view thereof;
FIG. 6 is a right side elevational view thereof; and,
FIG. 7 is a perspective view thereof.

1 Claim, 7 Drawing Sheets

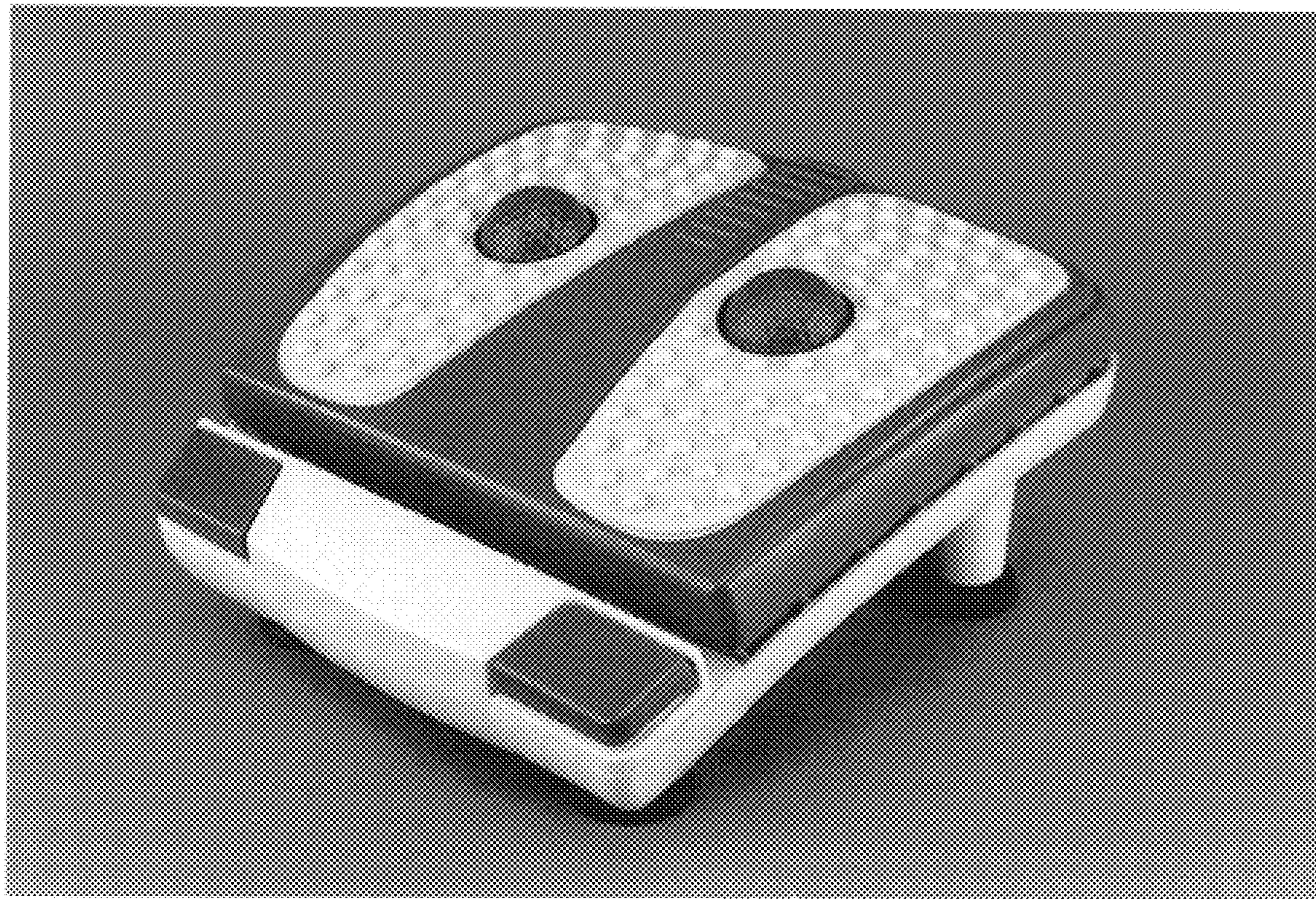

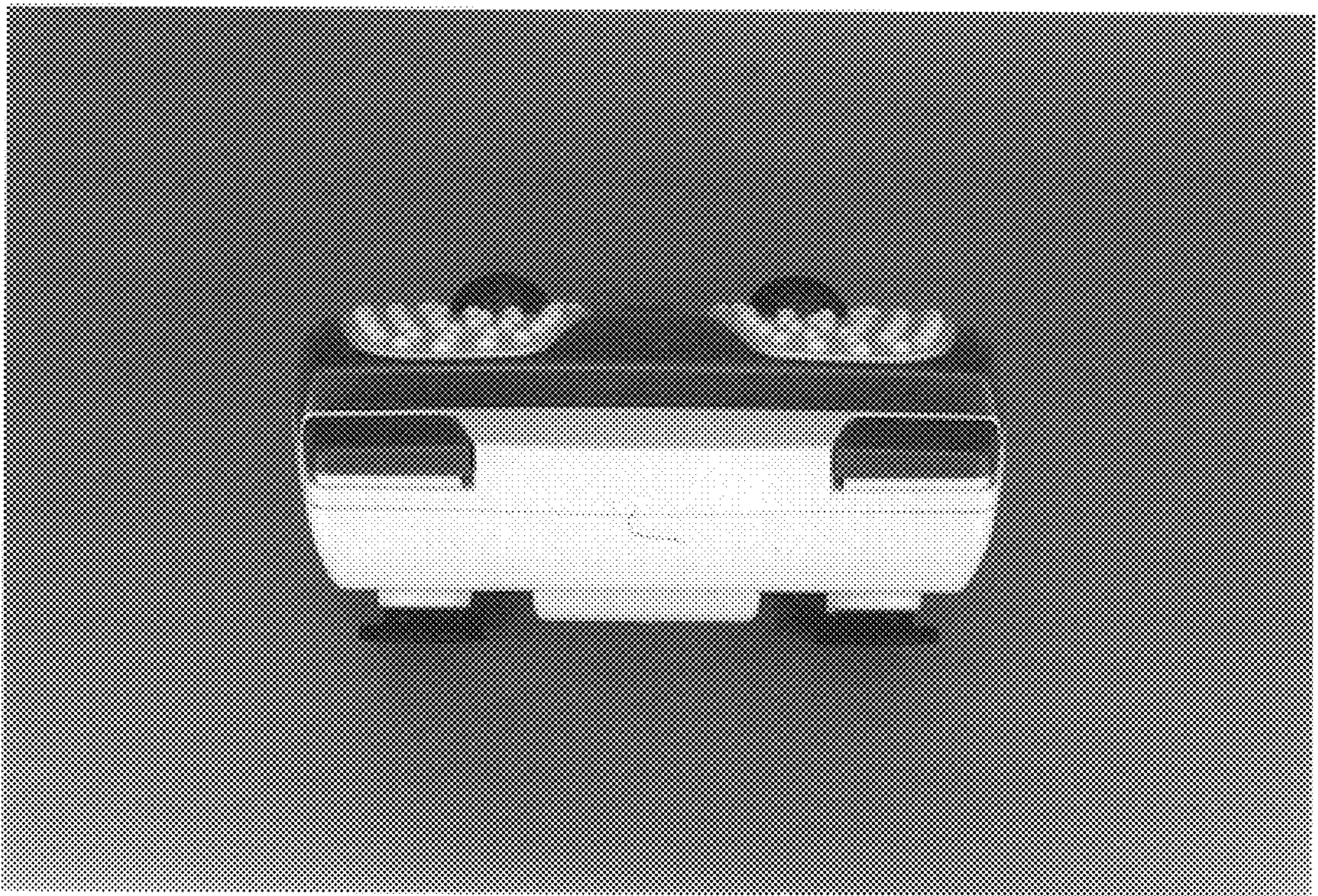

FIG. 1

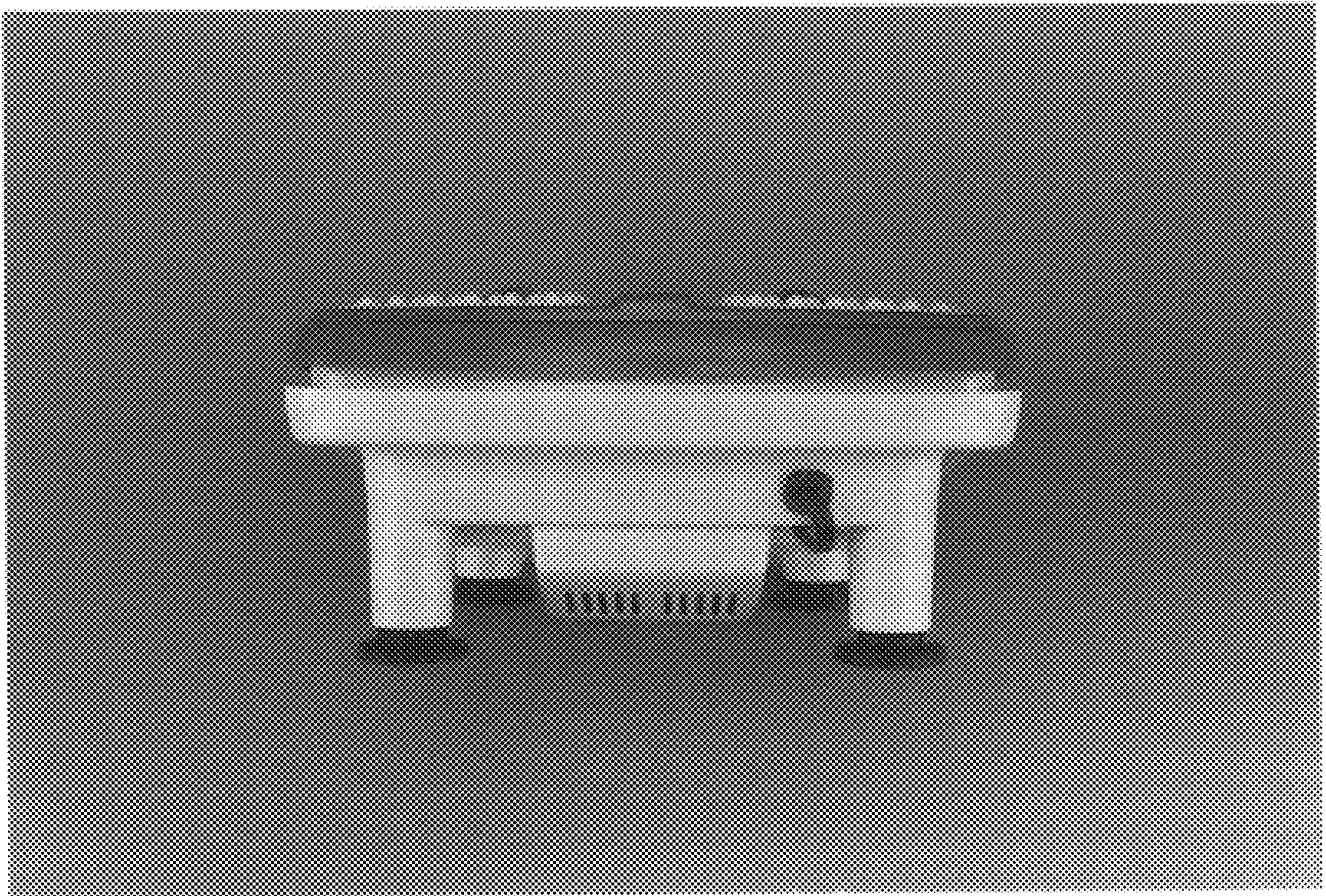

FIG. 2

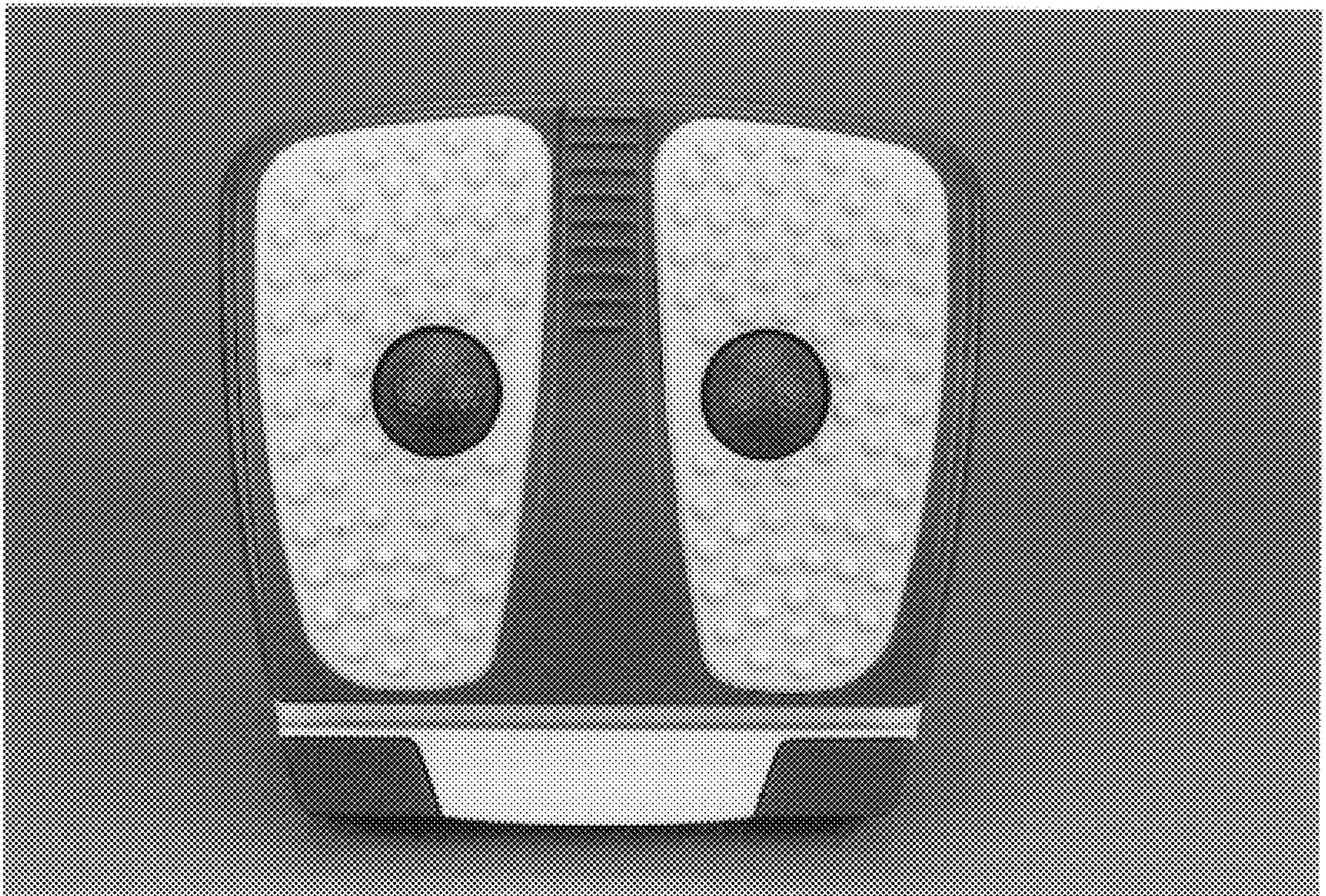

FIG. 3

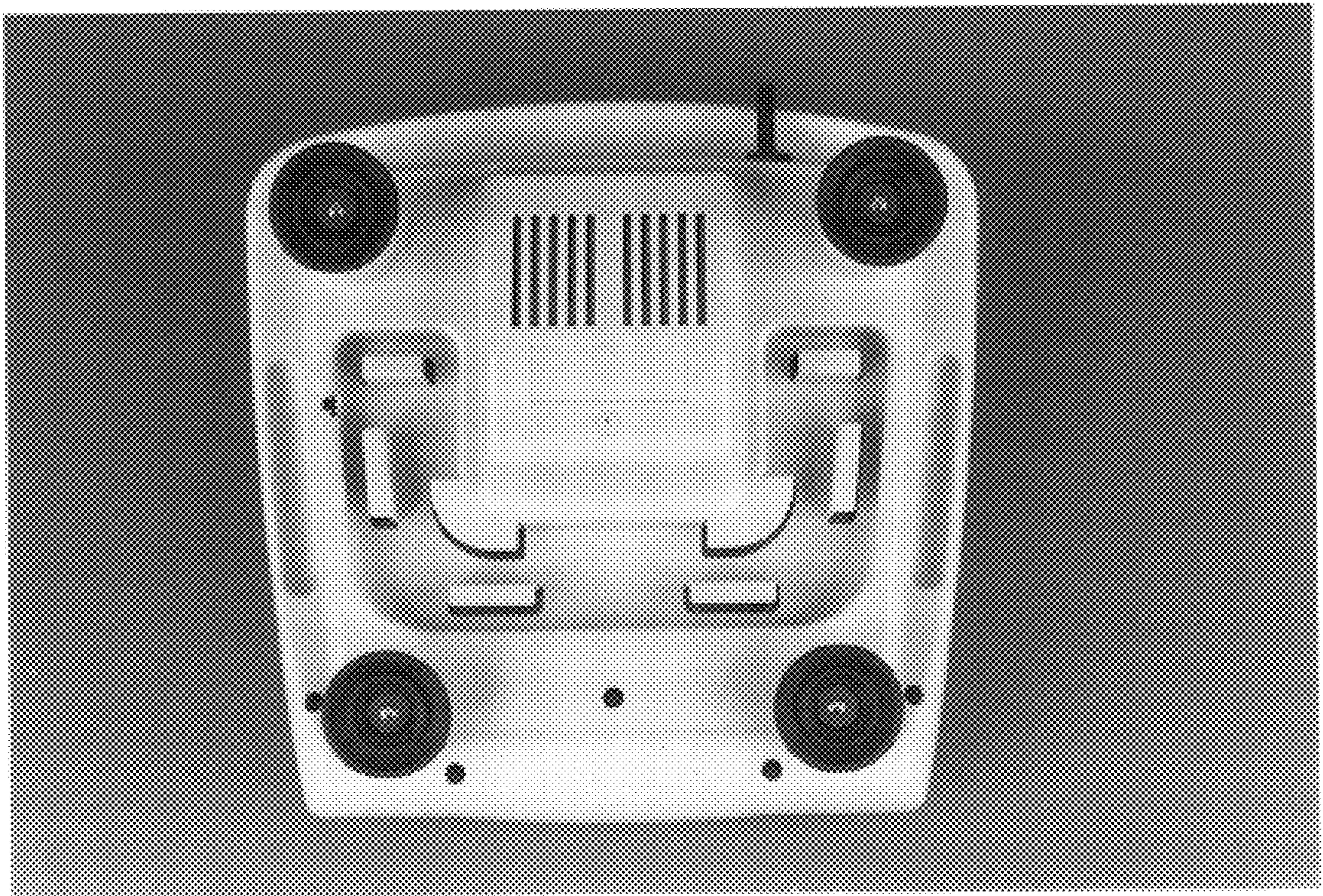

FIG. 4

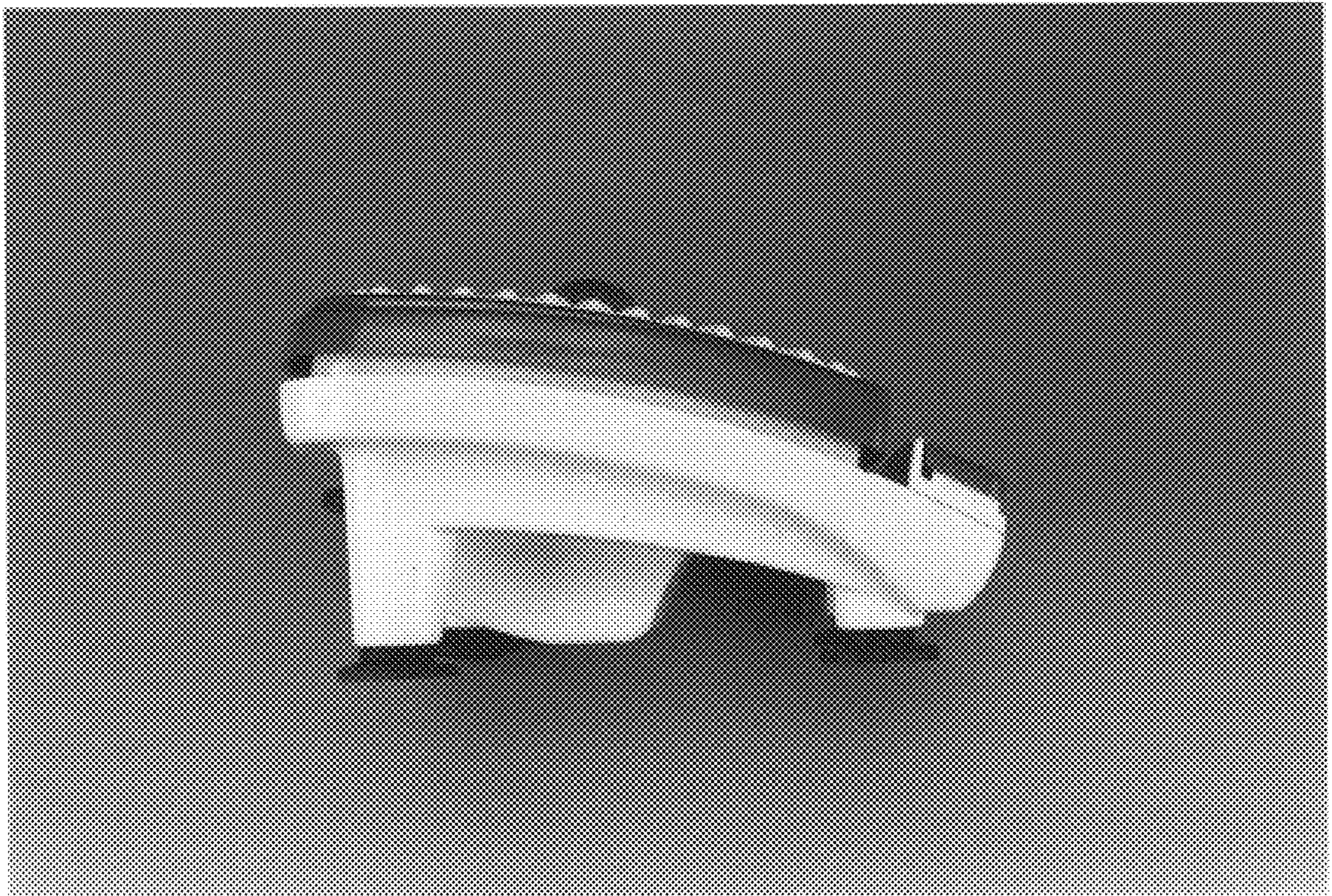

FIG. 5

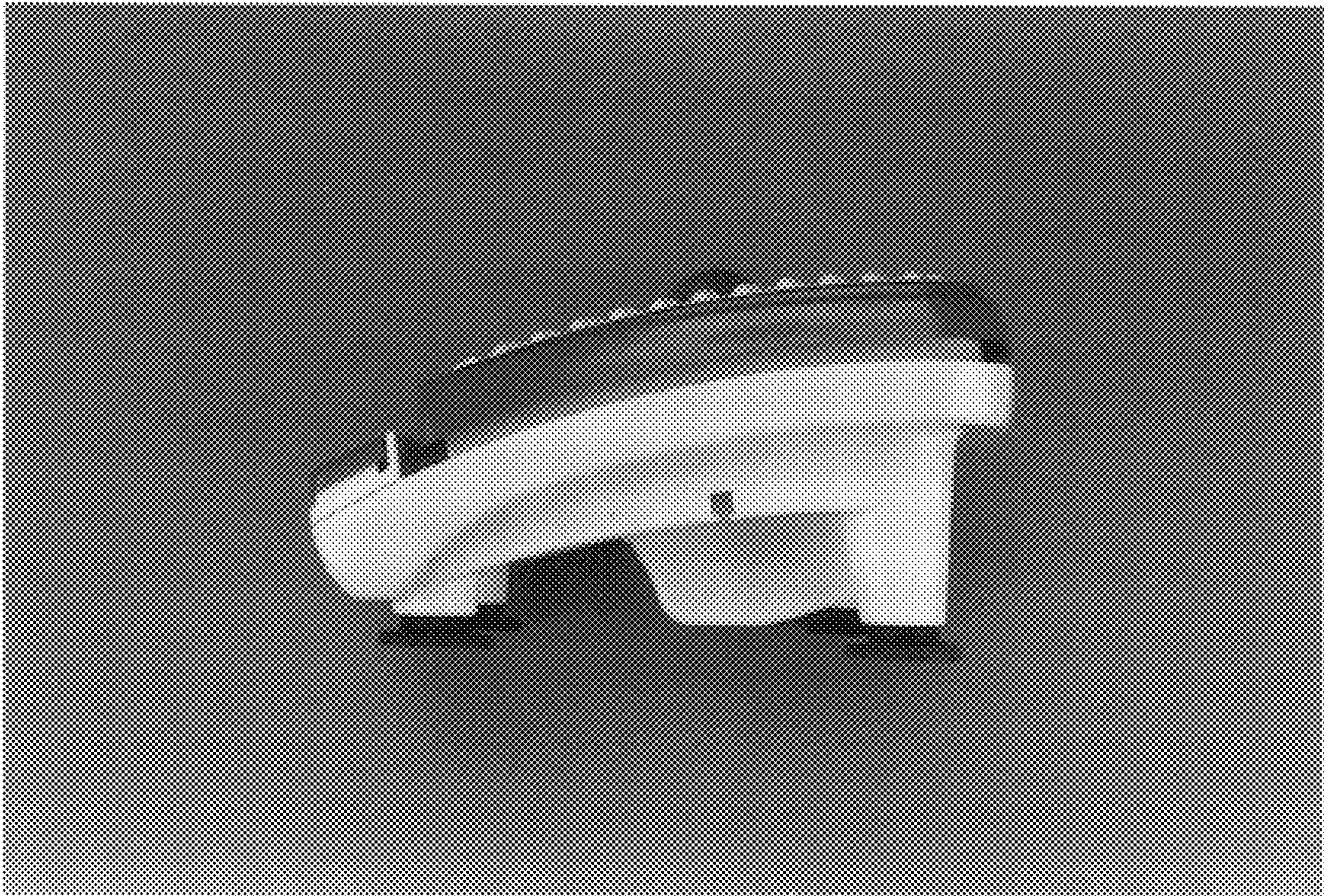

FIG. 6

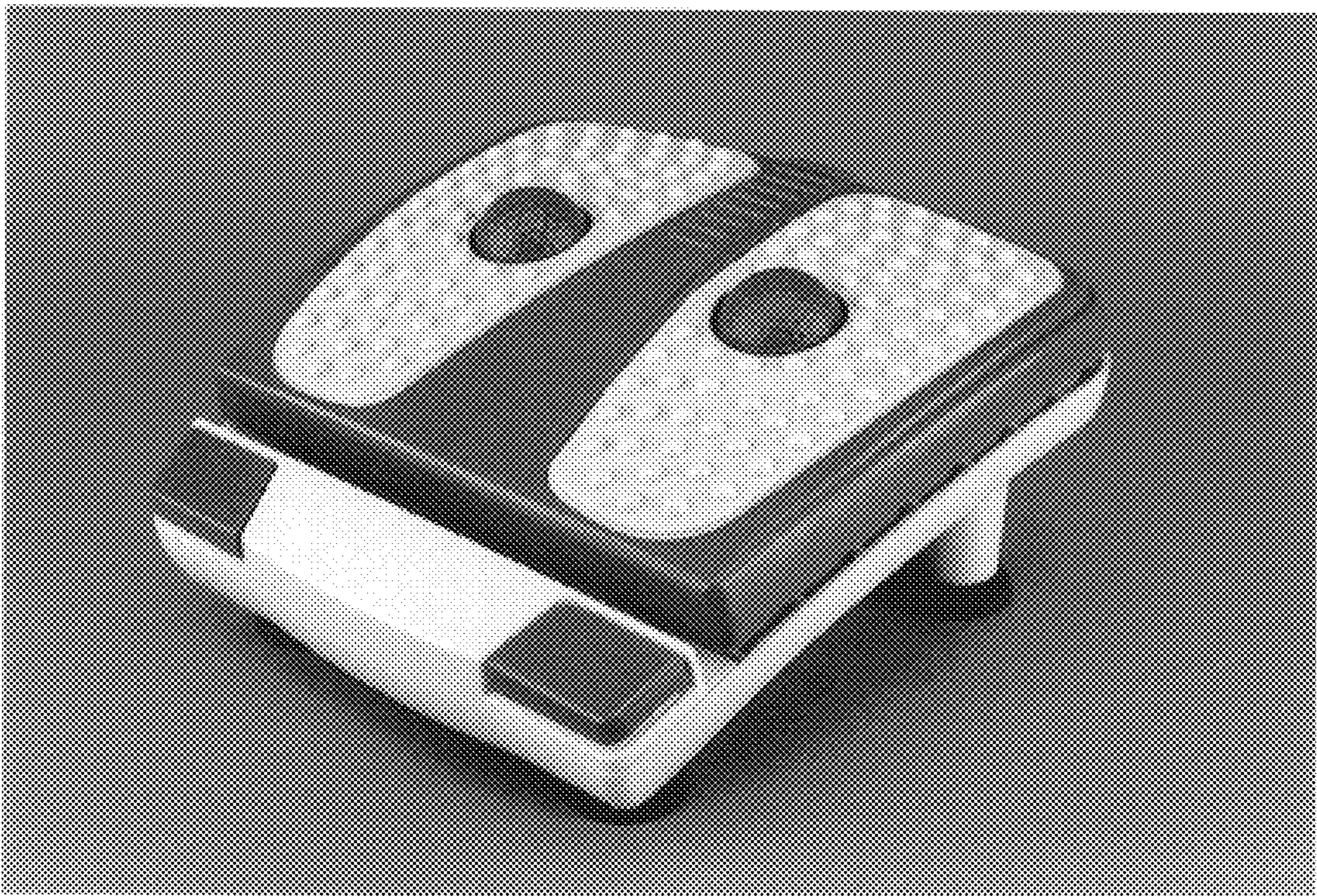

FIG. 7