



US00D432209S

United States Patent [19]

[11] **Patent Number: Des. 432,209**

Jou

[45] **Date of Patent: ** Oct. 17, 2000**

[54] **SPRAY GUN**

D. 398,954	9/1998	Jou	D23/226
4,651,929	3/1987	Kranzle	239/526
5,718,668	2/1998	Arnett et al.	239/526

[76] Inventor: **Wuu-Cheau Jou**, No. 95, Cheng Kung 2nd Road, Tali City, Taichung Hsien, Taiwan

Primary Examiner—Robin V. Taylor
Attorney, Agent, or Firm—Rosenberg, Klein & Lee

[**] Term: **14 Years**

[57] **CLAIM**

[21] Appl. No.: **29/111,151**

The ornamental design for spray gun, as shown and described.

[22] Filed: **Sep. 23, 1999**

[51] **LOC (7) Cl.** **23-01**

DESCRIPTION

[52] **U.S. Cl.** **D23/226**

FIG. 1 is a front view of spray gun showing my present design;

[58] **Field of Search** D23/213, 223, D23/226, 229; 239/525-6, 458-9, 394

FIG. 2 is a rear view thereof;

FIG. 3 is a top plan view thereof;

FIG. 4 is a bottom plan view thereof;

FIG. 5 is a left view thereof;

FIG. 6 is a right view thereof; and,

FIG. 7 is a perspective view thereof.

[56] **References Cited**

U.S. PATENT DOCUMENTS

D. 214,562	7/1969	Studinger	D23/213
D. 219,214	11/1970	Eklund	D23/226
D. 364,673	11/1995	Gustafsson	D23/223
D. 387,129	12/1997	Shiao	D23/226

1 Claim, 5 Drawing Sheets

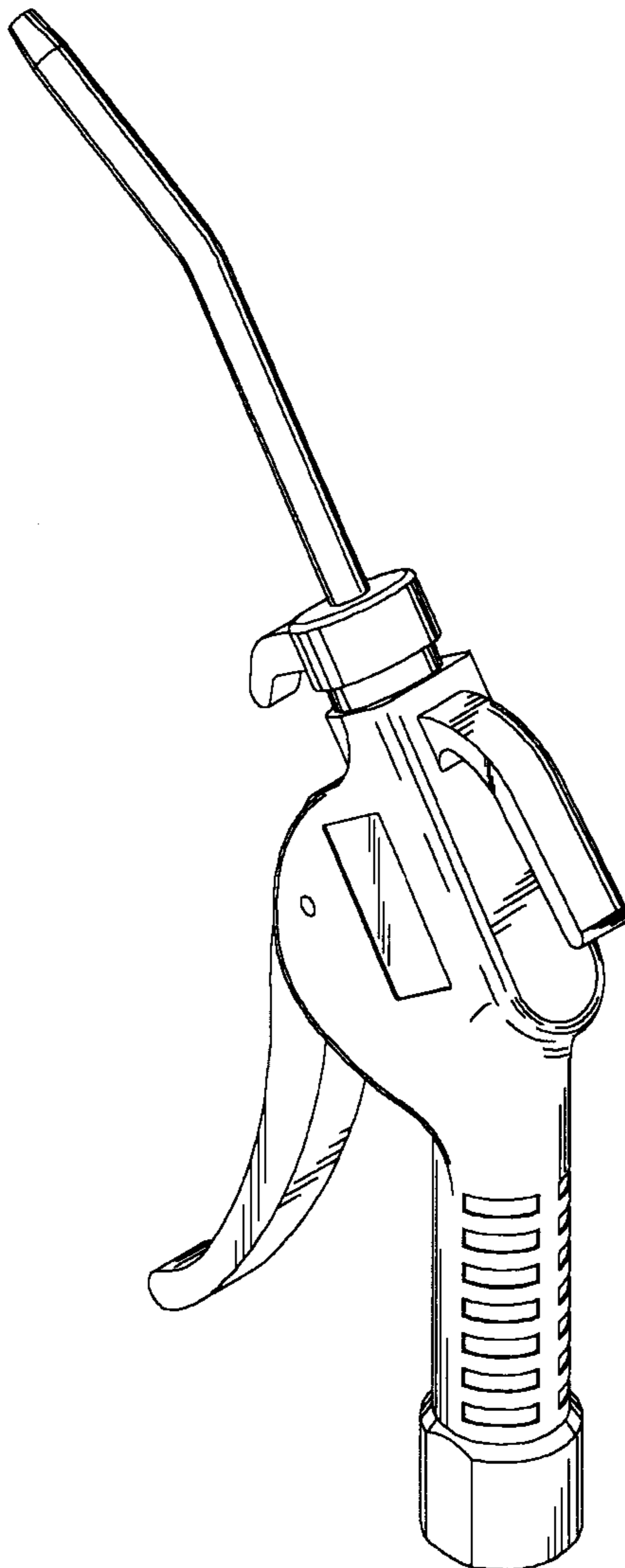

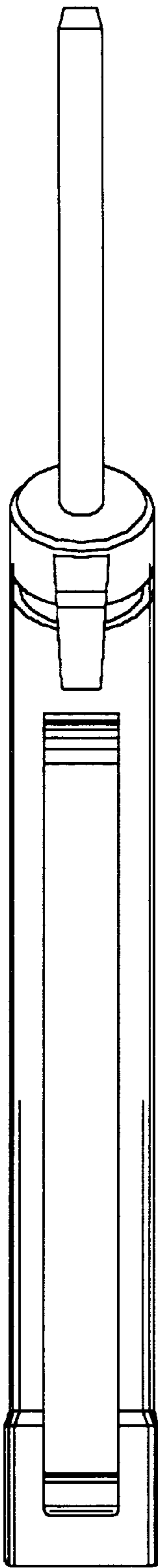

FIG. 1

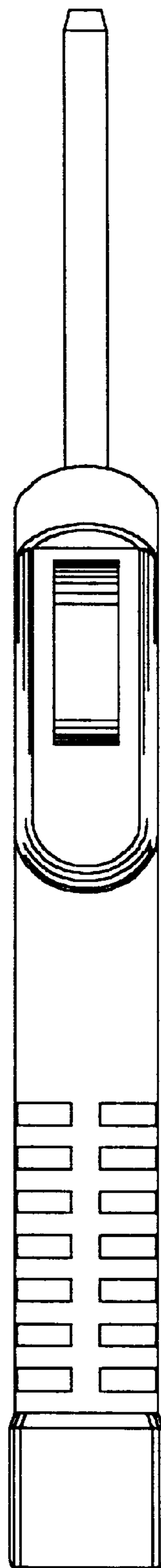

FIG. 2

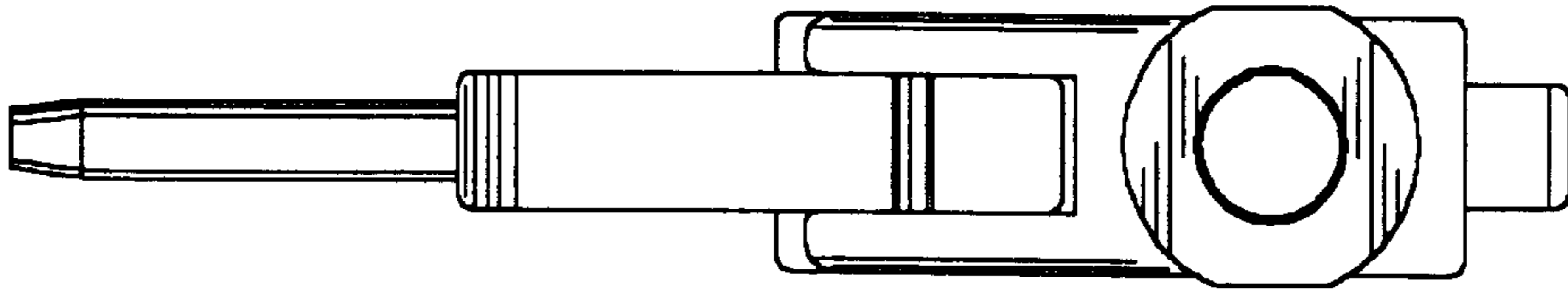

FIG. 4

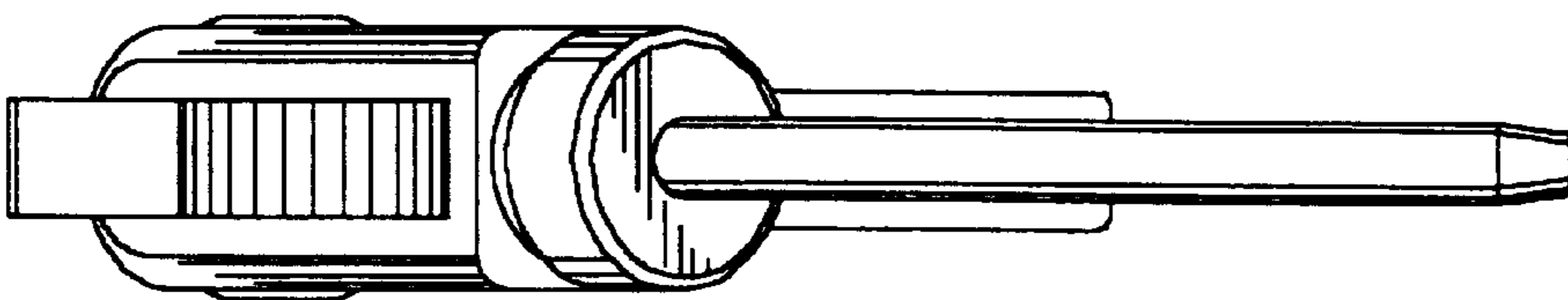

FIG. 3

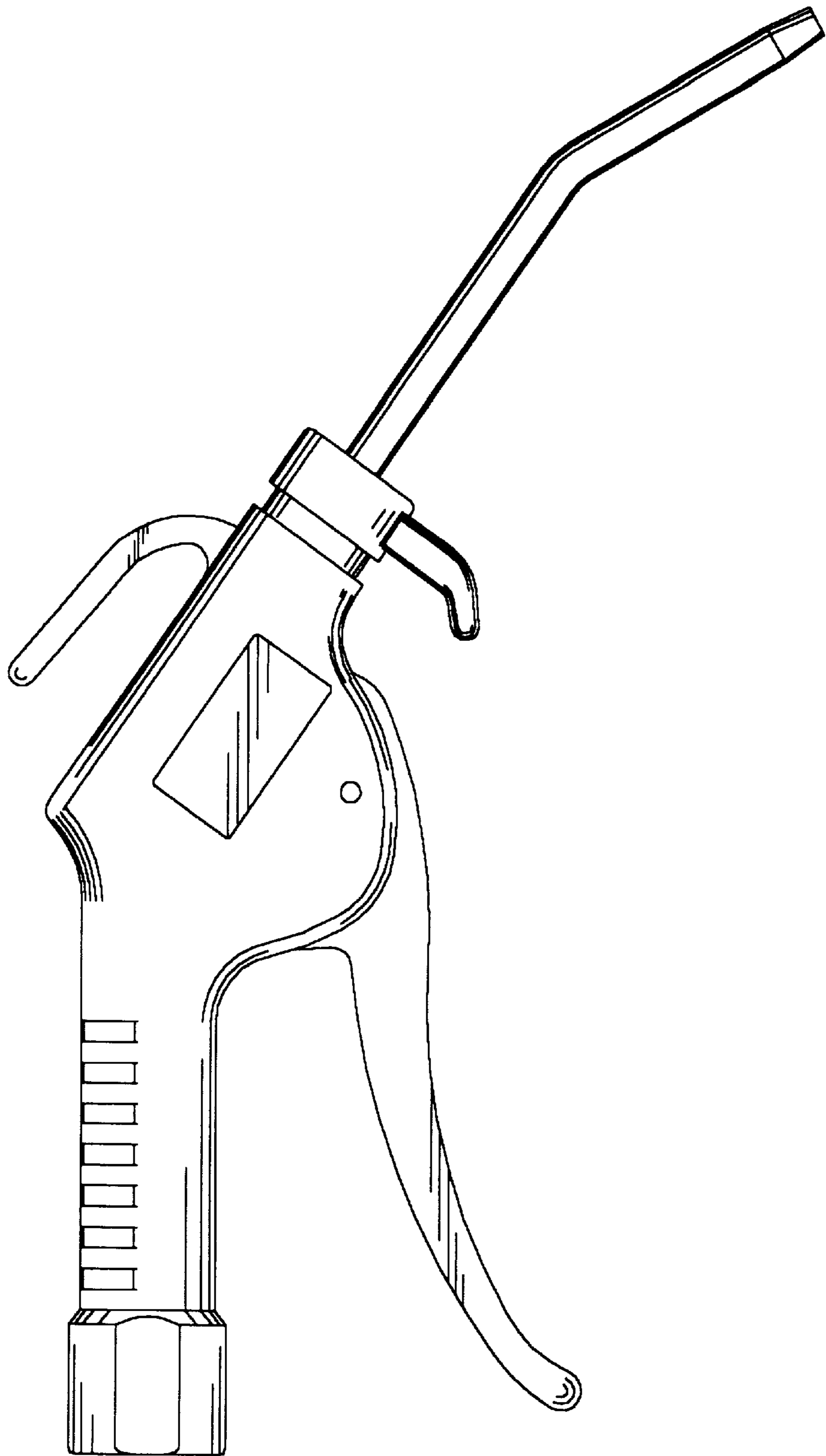

FIG. 5

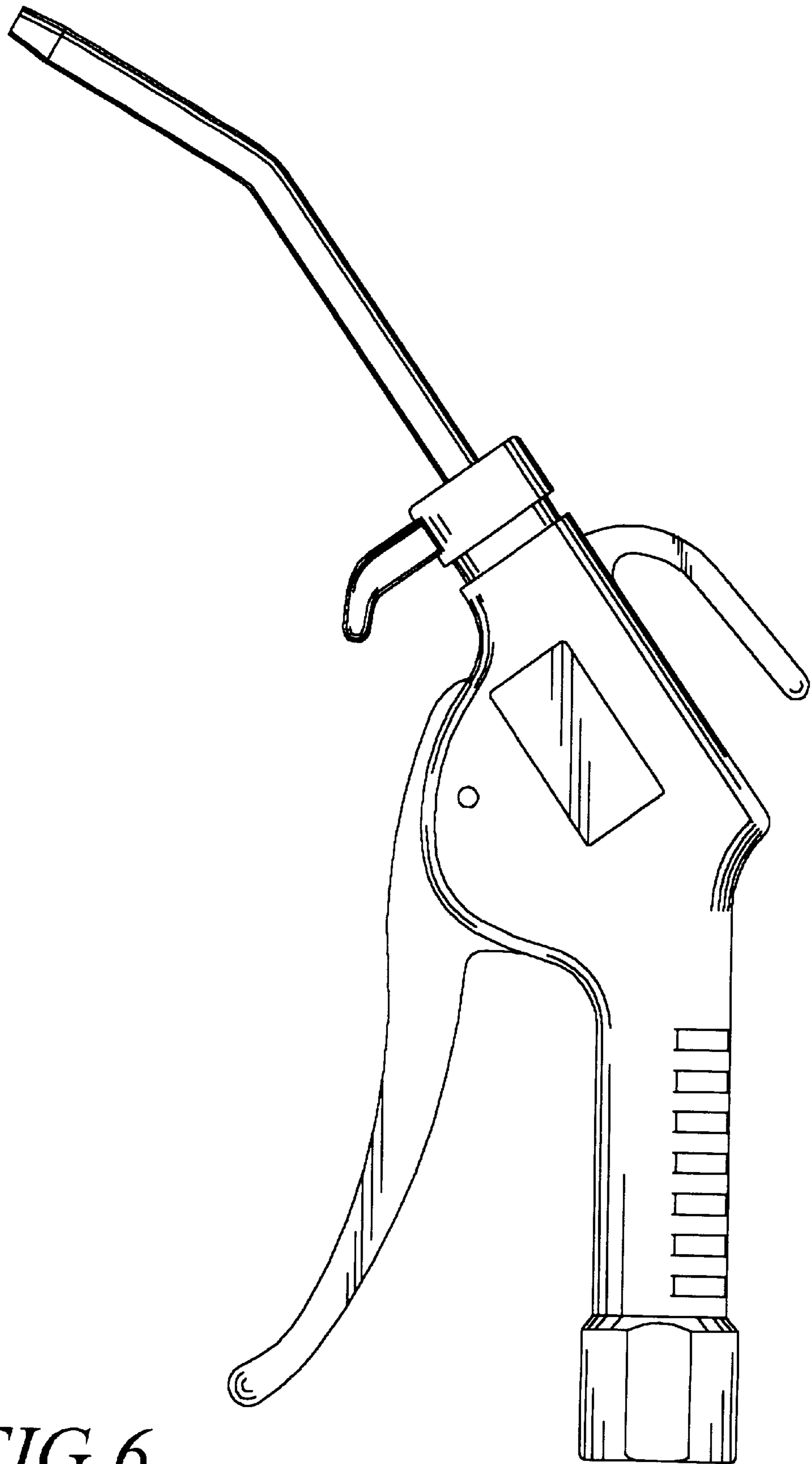

FIG. 6

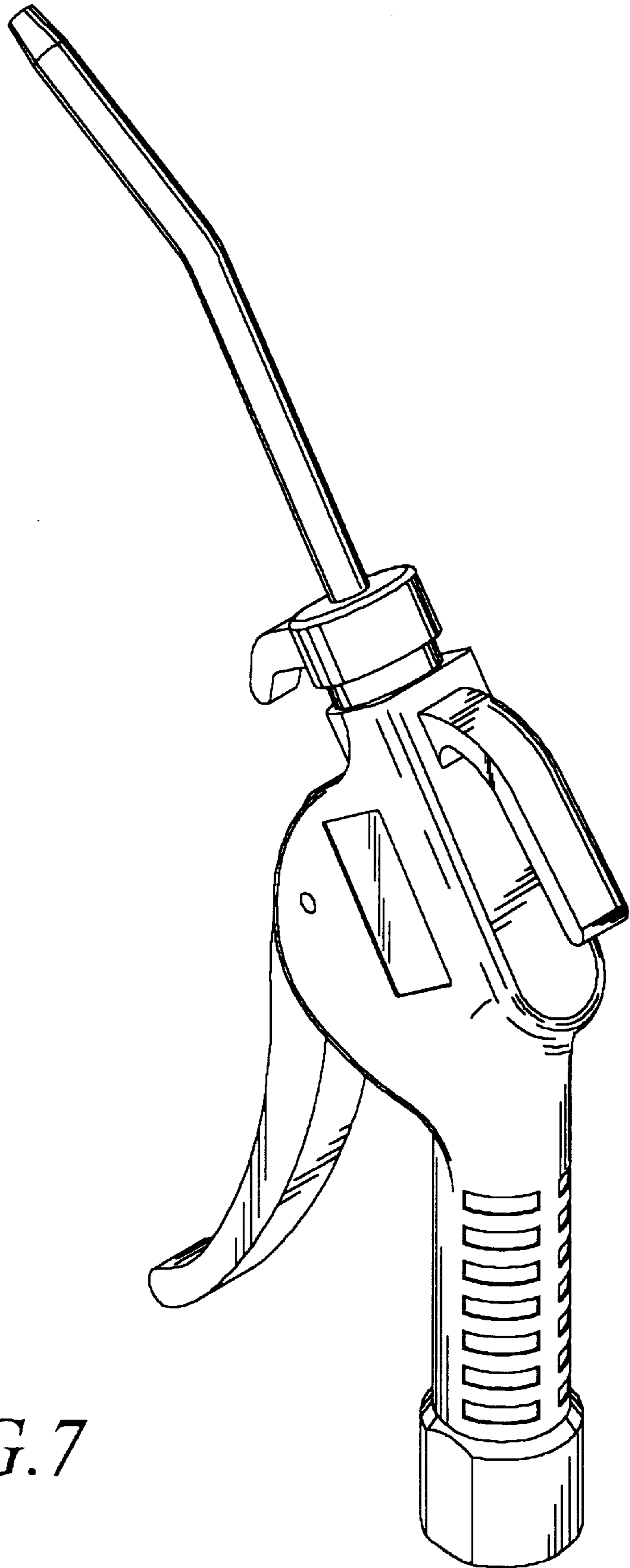

FIG. 7