

US00D432204S

**United States Patent** [19]  
**Brady**

[11] **Patent Number: Des. 432,204**

[45] **Date of Patent: \*\* Oct. 17, 2000**

[54] **WATER FILTER**

[75] Inventor: **Martin Brady**, Chesterfield, Va.

[73] Assignee: **Hamilton Beach/Proctor-Silex, Inc.**,  
Glen Allen, Va.

[\*\*] Term: **14 Years**

[21] Appl. No.: **29/104,358**

[22] Filed: **May 4, 1999**

[51] **LOC (7) Cl.** ..... **23-01**

[52] **U.S. Cl.** ..... **D23/209; D7/312**

[58] **Field of Search** ..... **D23/207, 209;**  
**D7/311, 312, 316-318; 210/435, 460**

[56] **References Cited**

**U.S. PATENT DOCUMENTS**

D. 323,874	2/1992	Hirman et al. ....	D23/209
D. 331,446	12/1992	Gidman .....	D23/209
D. 348,305	6/1994	Bannigan .....	D23/209
D. 355,241	2/1995	Zylstra et al. ....	D23/209
D. 362,583	9/1995	Weber et al. ....	D23/209
D. 398,366	9/1998	Ulery et al. ....	D23/209
5,526,596	6/1996	Bitzel et al. .	

**OTHER PUBLICATIONS**

Front and rear cover and p. 34 of "Rowenta International 86"  
1986 Product Catalog.

See Information Disclosure Statement regarding offer for  
sale less than one year prior to filing date of present  
application.

*Primary Examiner*—Robin V. Taylor

*Attorney, Agent, or Firm*—Roger S. Dybvig

[57] **CLAIM**

The ornamental design for water filter, as shown and  
described.

**DESCRIPTION**

FIG. 1 is a perspective view as seen from the top, front, and  
right side of a water filter showing my new design;

FIG. 2 is a front elevational view thereof;

FIG. 3 is a rear elevational view thereof;

FIG. 4 is a left side elevational view thereof, the right side  
elevational view being a mirror image of the left side  
elevational view;

FIG. 5 is a top plan view thereof;

FIG. 6 is bottom plan view thereof; and,

FIG. 7 is a perspective view thereof similar to FIG. 1 but  
showing the lid of the water filter in an open position.

**1 Claim, 3 Drawing Sheets**

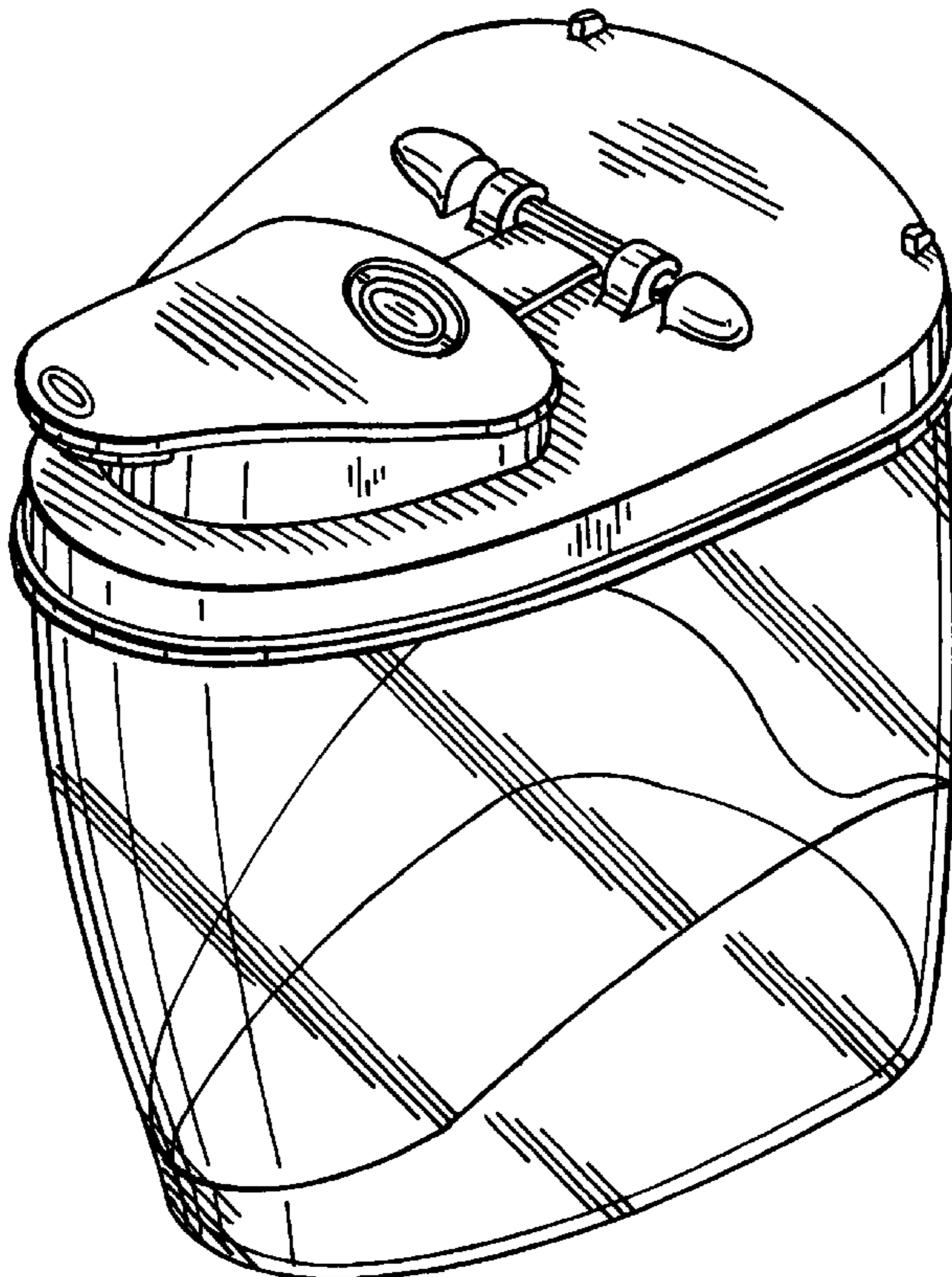

FIG-1

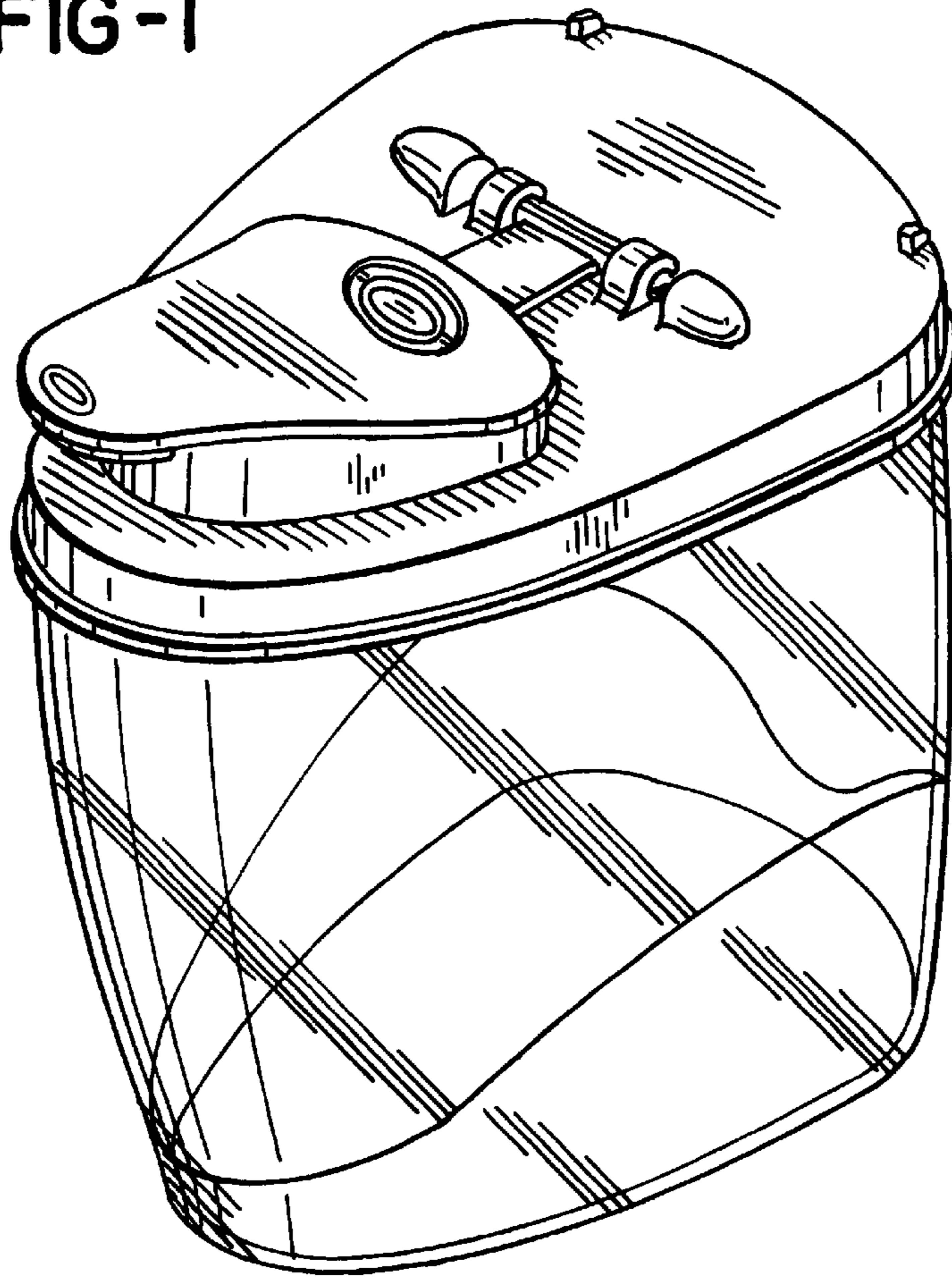

FIG-2

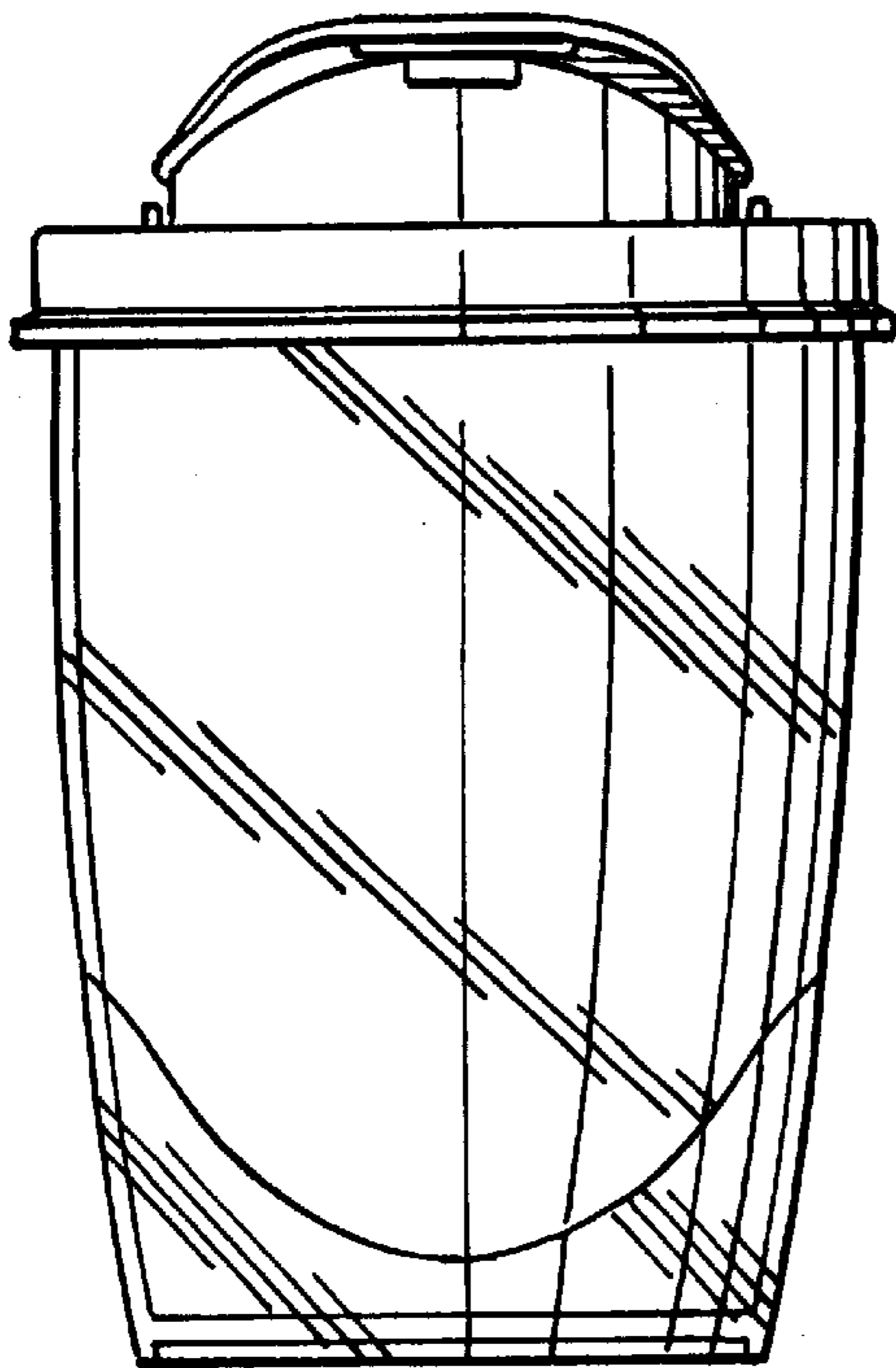

FIG-3

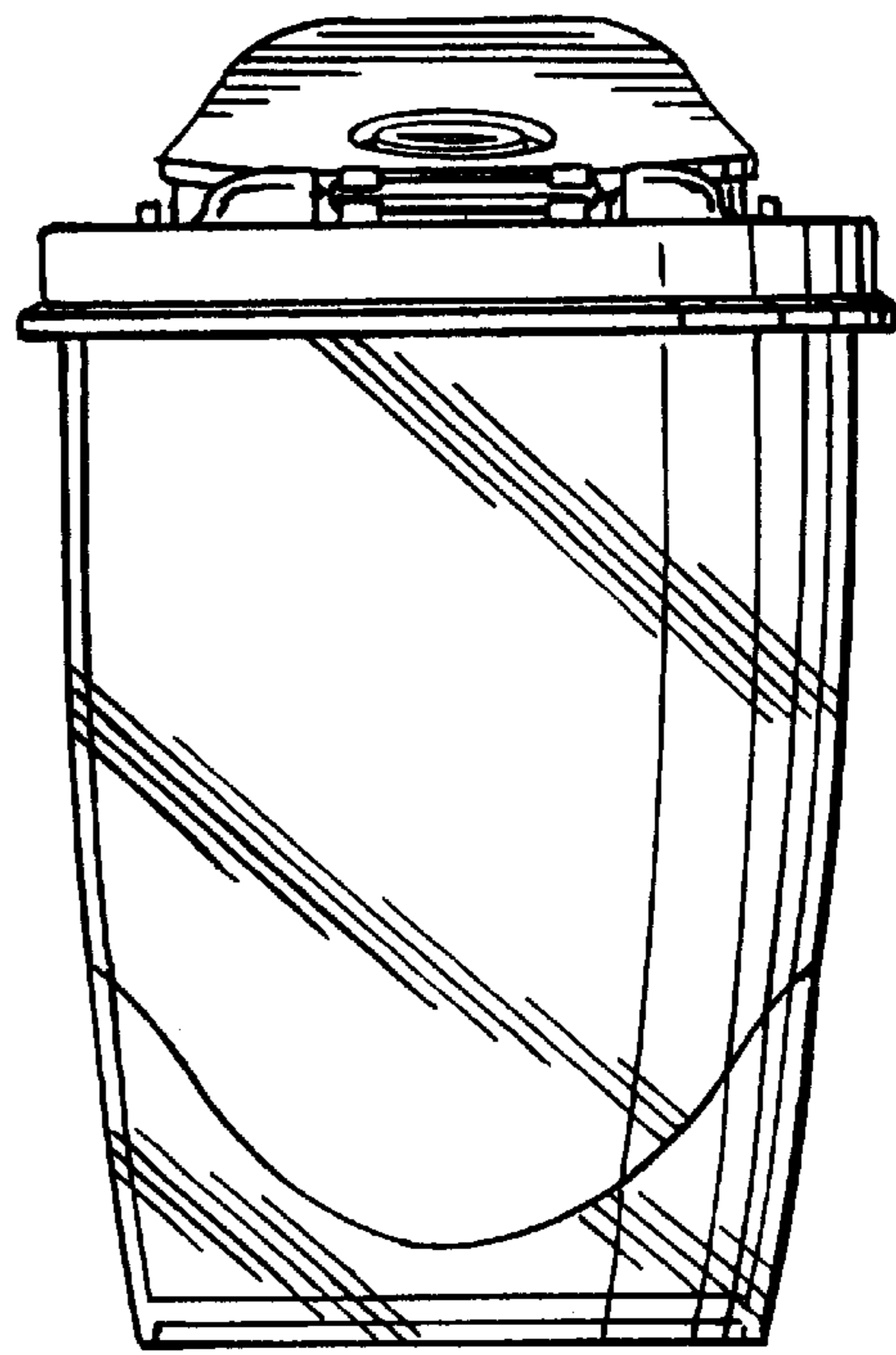

FIG-4

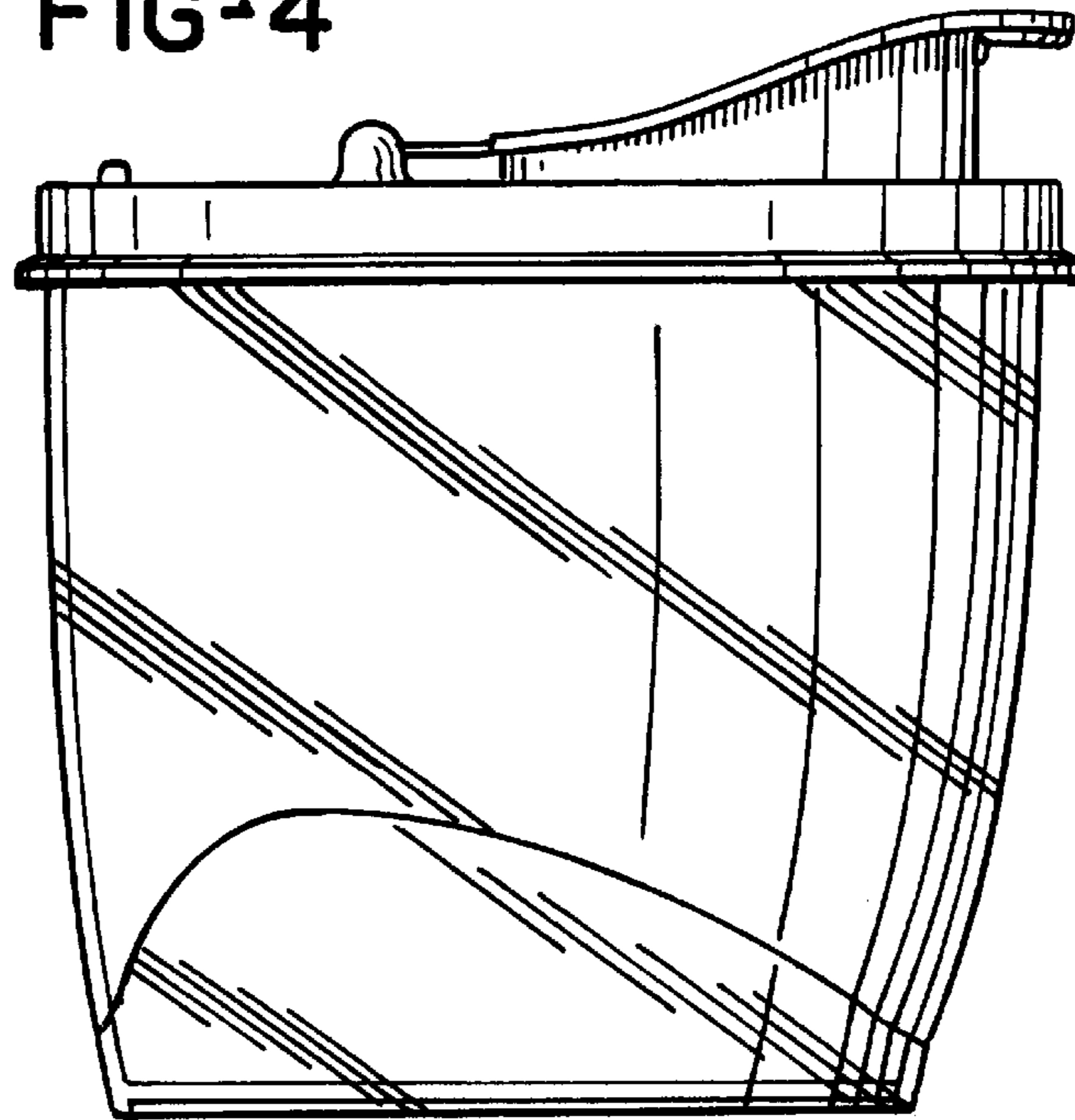

FIG-5

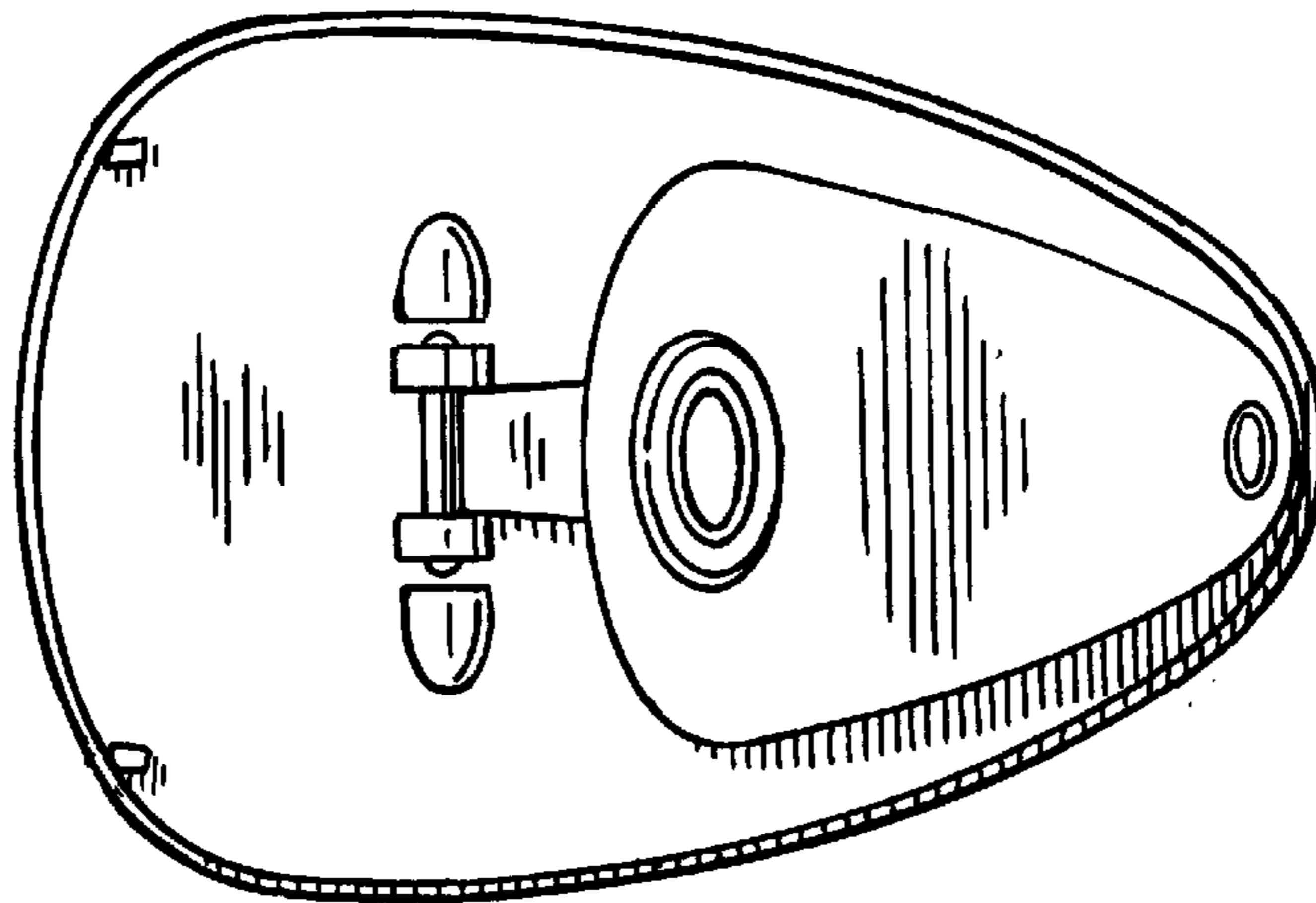
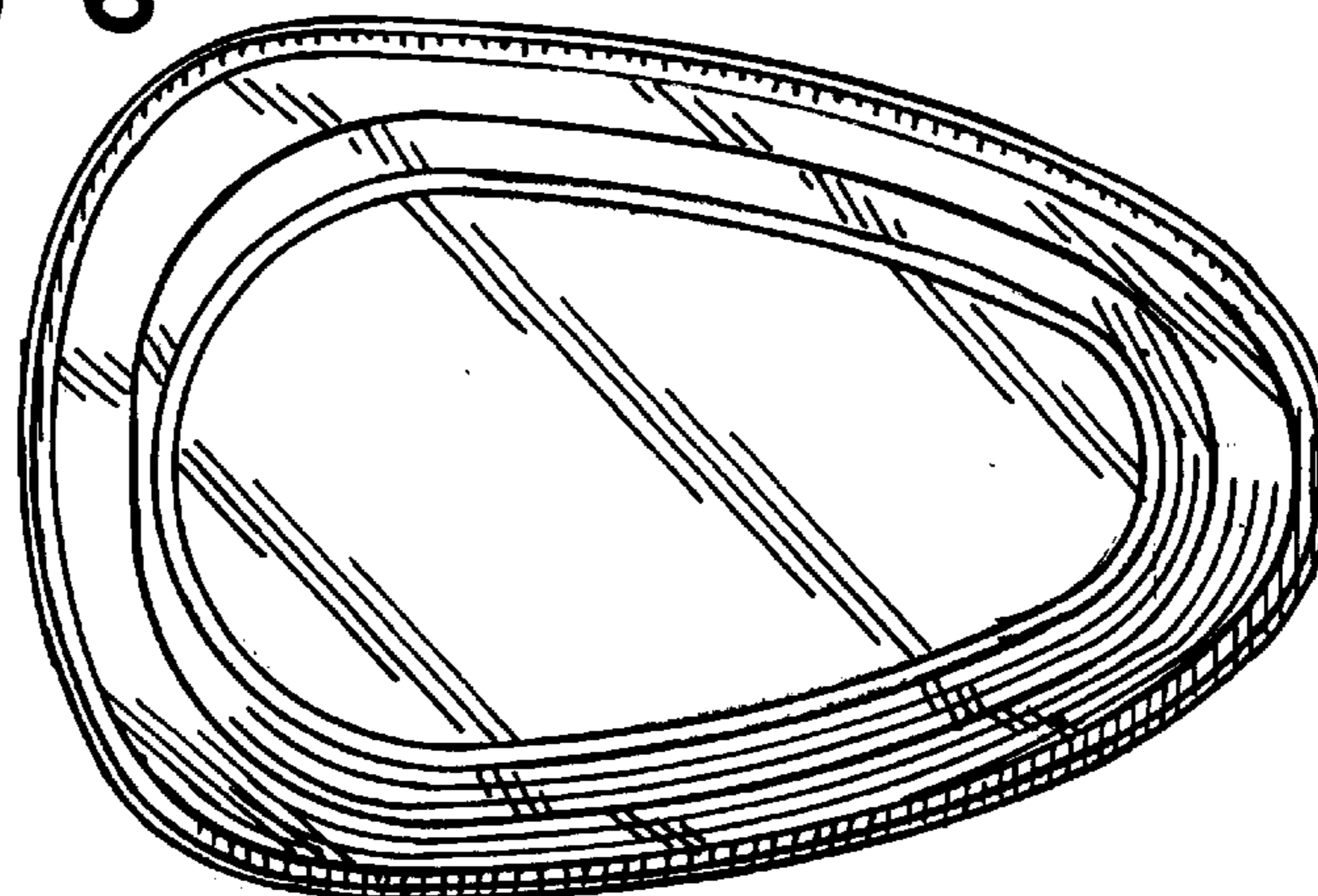

FIG-6



**FIG-7**

