



US00D432198S

United States Patent [19]
Adam

[11] **Patent Number: Des. 432,198**

[45] **Date of Patent: ** Oct. 17, 2000**

[54] **PITCH MARK REPAIRER**

[75] Inventor: **Pamela Maxine Adam**, Hampton, Australia

[73] Assignee: **Lavatist Holdings Pty Ltd.**, Victoria, Australia

[**] Term: **14 Years**

[21] Appl. No.: **29/110,414**

[22] Filed: **Sep. 3, 1999**

[30] **Foreign Application Priority Data**

Mar. 5, 1999 [AU] Australia 690/99

[51] **LOC (7) Cl.** **21-02**

[52] **U.S. Cl.** **D21/793**

[58] **Field of Search** D21/793; 473/286, 473/408

[56] **References Cited**

U.S. PATENT DOCUMENTS

D. 360,450	7/1995	Louden et al.	D21/793
D. 381,055	7/1997	Jones et al.	D21/793
D. 390,904	2/1998	Newbold et al.	D21/793
D. 401,296	11/1998	Cole et al.	D21/793
D. 401,379	11/1998	Goldftas	D21/793
5,529,299	6/1996	Bellagamba	473/286
6,022,280	2/2000	Arenburg et al.	473/408

Primary Examiner—Mitchell Siegel

Attorney, Agent, or Firm—Ladas & Parry

[57] **CLAIM**

I claim the ornamental design for a pitch mark repairer, as shown and described.

DESCRIPTION

FIG. 1 is a front elevational view showing the design as applied to a pitch mark repairer.

FIG. 2 is a rear elevational view showing the design as applied to a pitch mark repairer.

FIG. 3 is a right side elevational view of the design as applied to a pitch mark repairer, the left elevational view being a mirror image and, therefore, not shown.

FIG. 4 is a top plan view of a design as applied to a pitch mark repairer.

FIG. 5 is a bottom plan view of the design as applied to a pitch mark repairer.

FIG. 6 is a top right front perspective view of a design as applied to a pitch mark repairer; and,

FIG. 7 is a top left rear view of the design as applied to a pitch mark repairer.

The design consists of the portion of the pitch mark repairer shown in solid lines in the left figures. The portion of the pitch mark repairer shown in broken lines beneath the upper transverse broken line in FIG. 1 is not claimed.

The broken line showing of the lower portion of the pitch mark repairer is for illustrative purposes only and forms no part of the claimed design.

1 Claim, 1 Drawing Sheet

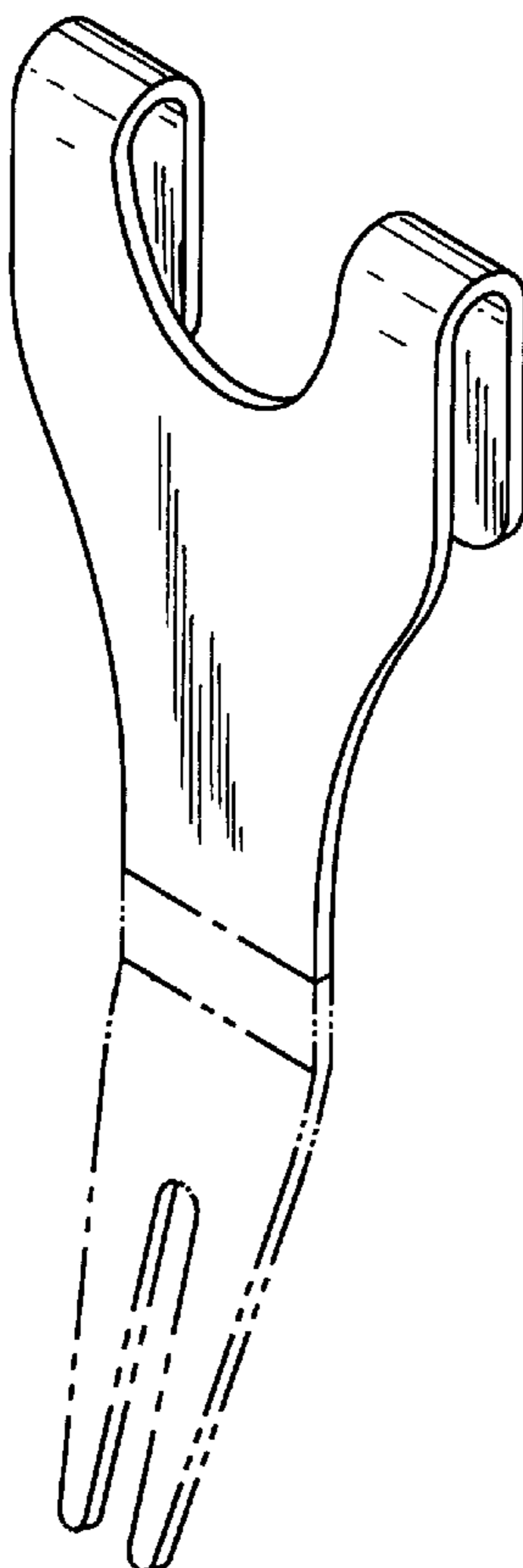

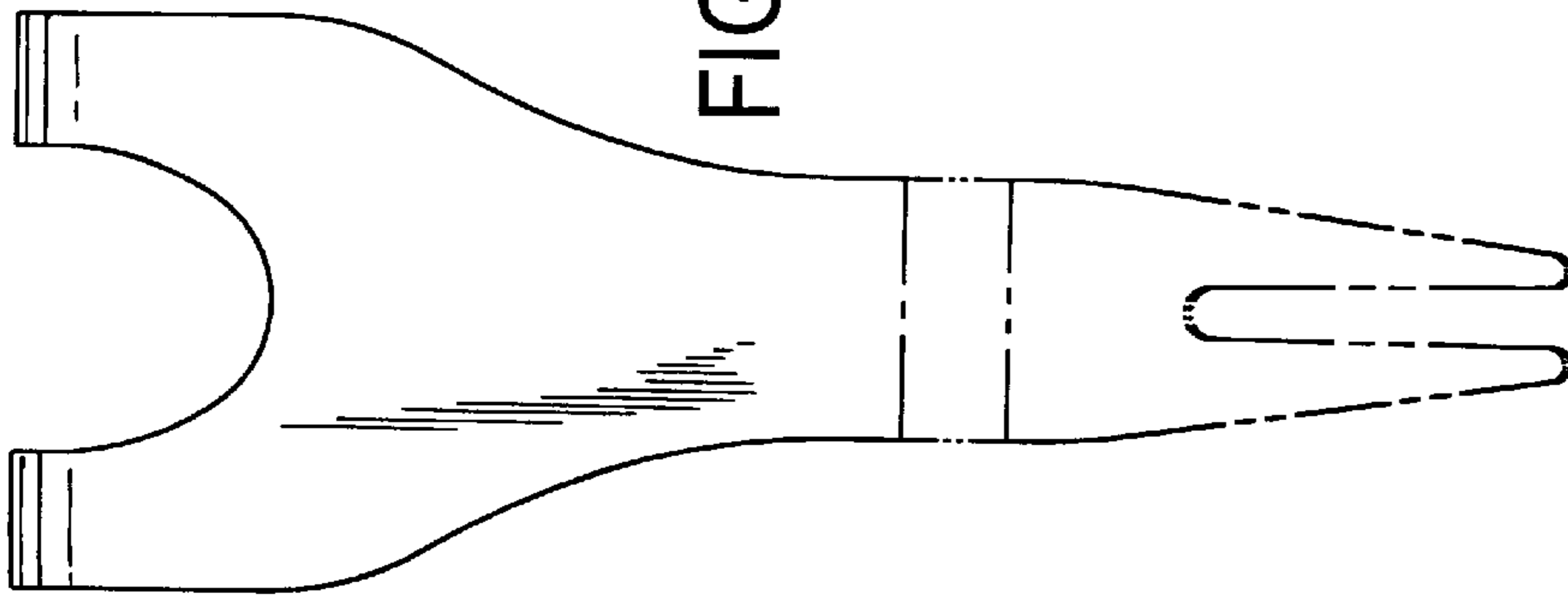

FIG 1

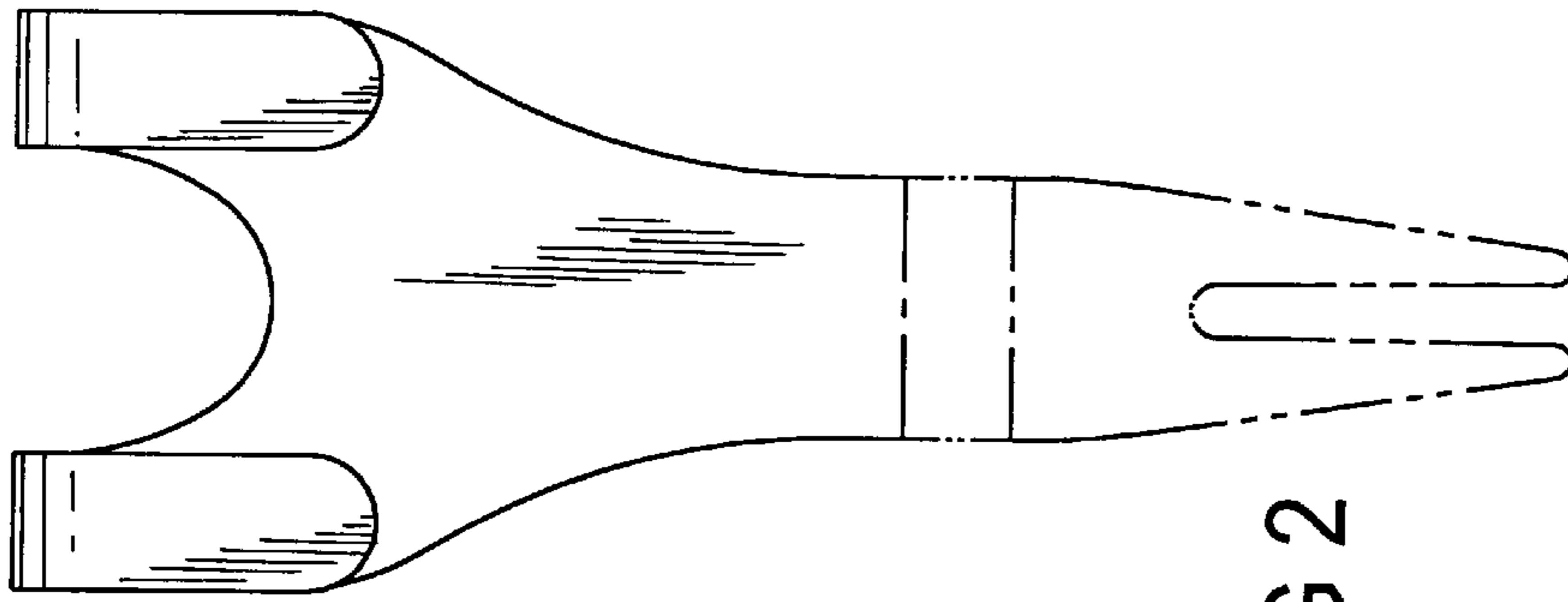

FIG 2

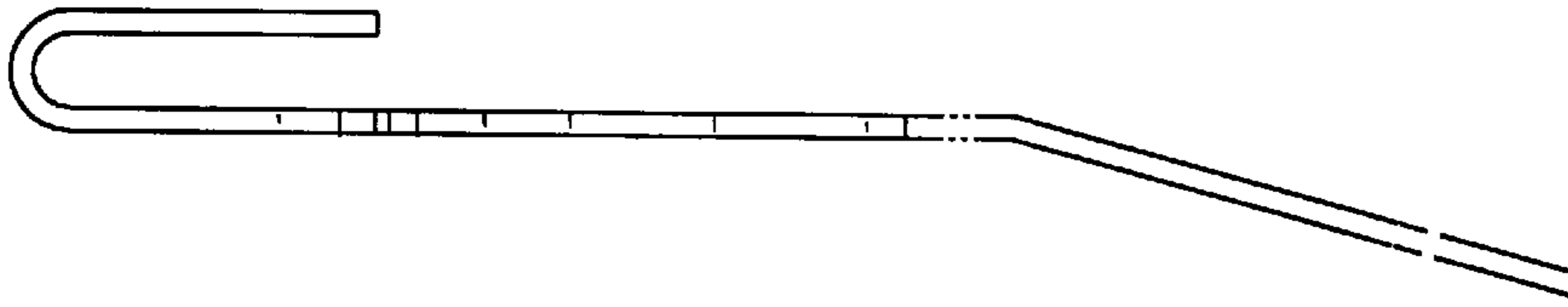

FIG 3

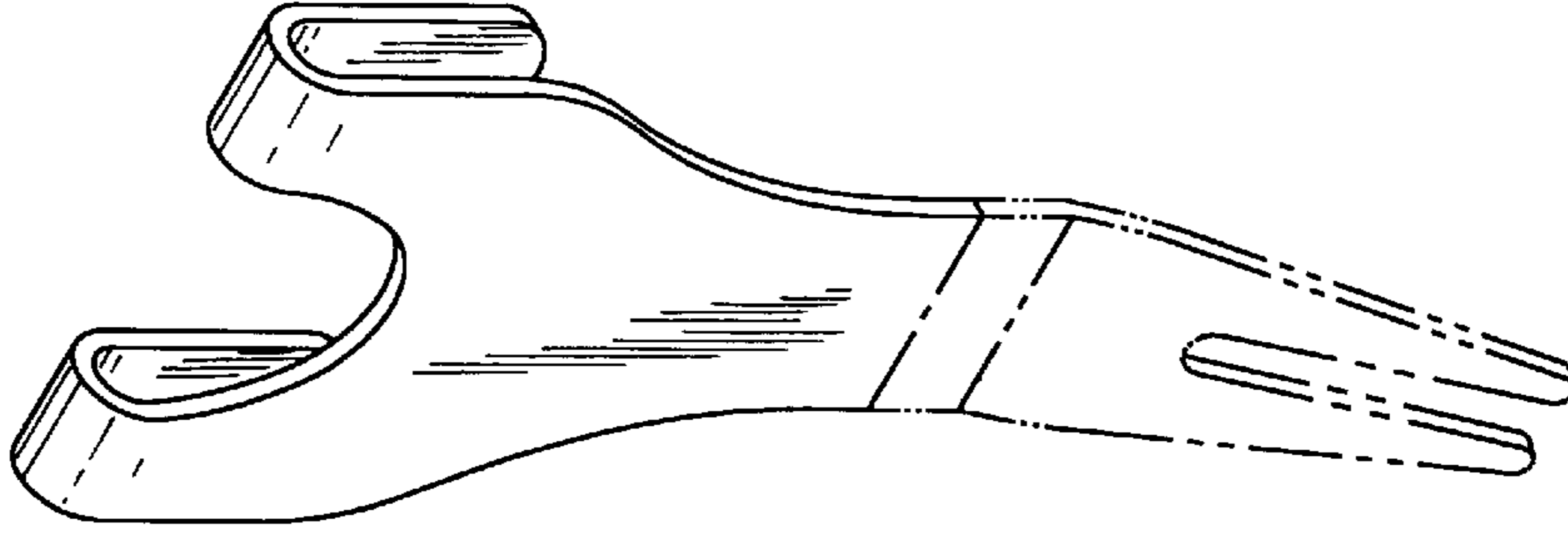

FIG 6

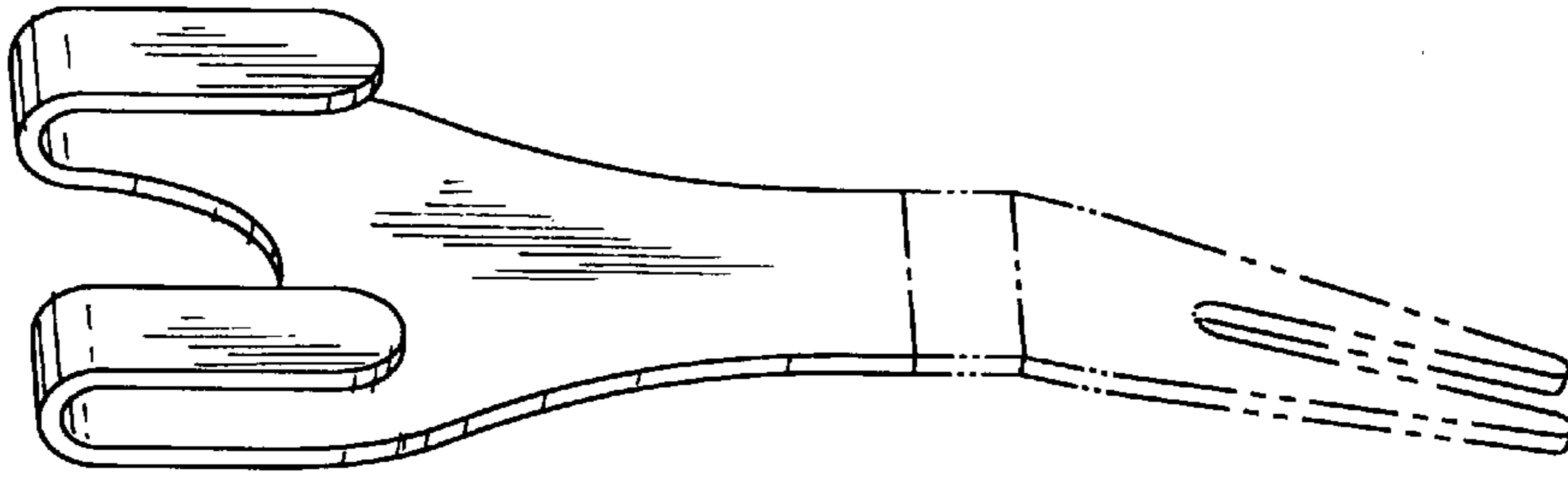

FIG 7

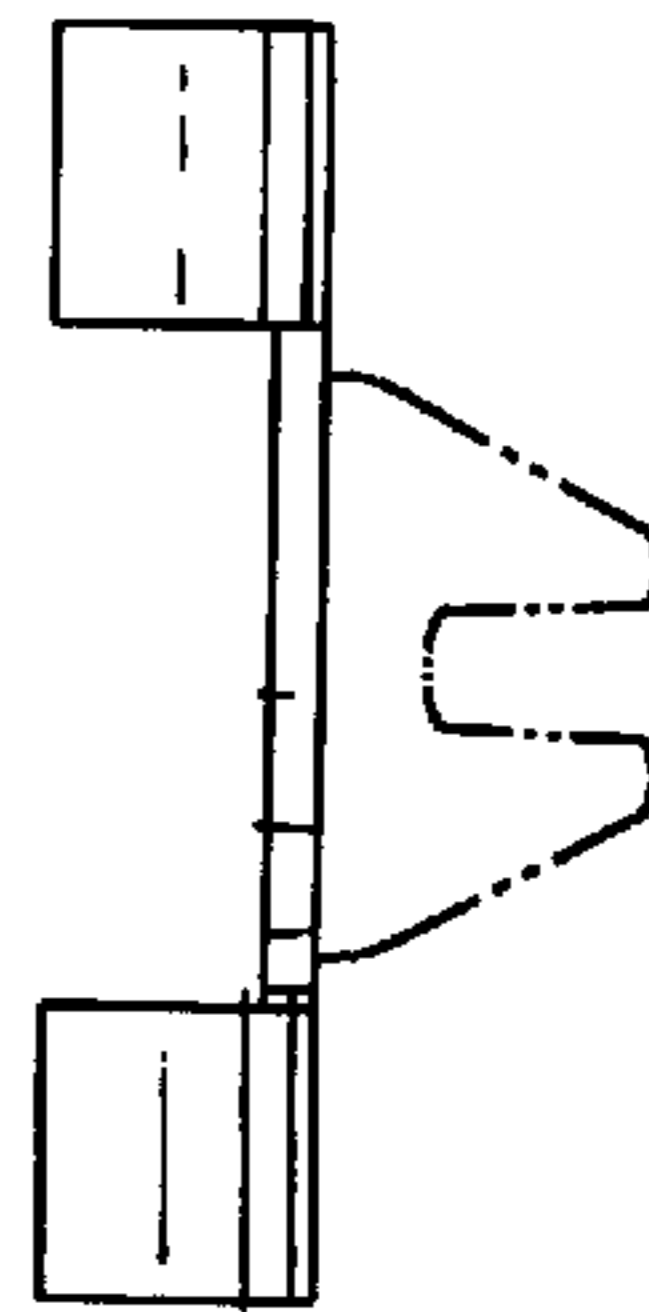

FIG 4

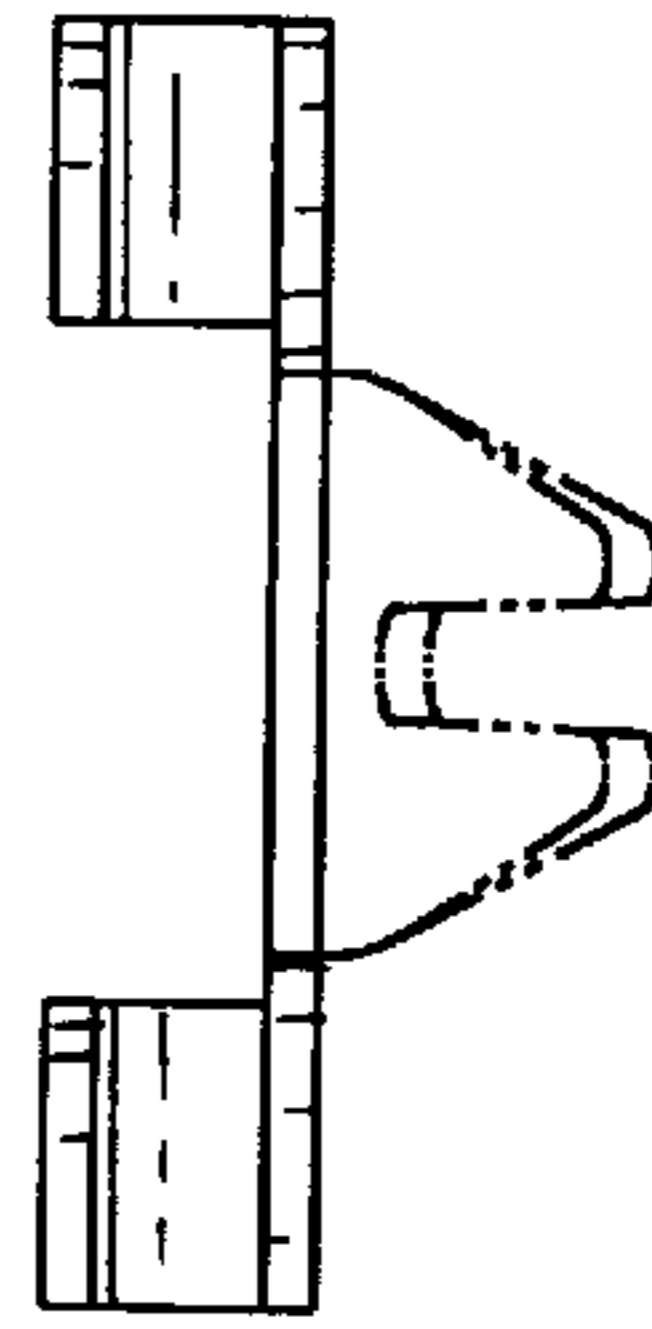

FIG 5