



US00D432169S

**United States Patent** [19]  
**Stravitz**

[11] **Patent Number: Des. 432,169**

[45] **Date of Patent: \*\* Oct. 17, 2000**

[54] **CARD FILE**

[76] Inventor: **David M. Stravitz**, 16 Park Ave. - Suite 14A, New York, N.Y. 10016

[\*\*] Term: **14 Years**

[21] Appl. No.: **29/115,128**

[22] Filed: **Dec. 8, 1999**

[51] **LOC (7) Cl.** ..... **19-02**

[52] **U.S. Cl.** ..... **D19/75; D19/76; D19/86; D19/90**

[58] **Field of Search** ..... D19/65, 75, 76, D19/77, 78, 81-85, 86, 90, 91, 92, 95, 99, 100; 206/214, 224, 371, 425, 555, 556; 211/10, 11, 44, 45, 50, 51, 55, 126.13

[56] **References Cited**

**U.S. PATENT DOCUMENTS**

D. 149,228 4/1948 Salsbury ..... D19/75  
D. 149,461 4/1948 Underwood ..... D19/92

D. 175,325 8/1955 Suestka ..... D19/91  
D. 179,546 1/1957 Miele ..... D19/75  
D. 194,008 11/1962 Bishop ..... D19/90  
D. 201,716 7/1965 Franklin ..... D19/92  
1,361,451 12/1920 Flannery, Jr. .... 211/55 X

*Primary Examiner*—Martie K. Holtje  
*Attorney, Agent, or Firm*—Frishauf, Holtz, Goodman, Langer & Chick, P.C.

[57] **CLAIM**

The ornamental design for an card file, as shown and described.

**DESCRIPTION**

FIG. 1 is a top, front and left side perspective view of a card file showing my new design;  
FIG. 2 is a top plan view thereof;  
FIG. 3 is a front elevational view thereof;  
FIG. 4 is a right side elevational view thereof, the left side elevational view being a mirror image;  
FIG. 5 is a rear elevational view thereof; and,  
FIG. 6 is a bottom plan view thereof.

**1 Claim, 5 Drawing Sheets**

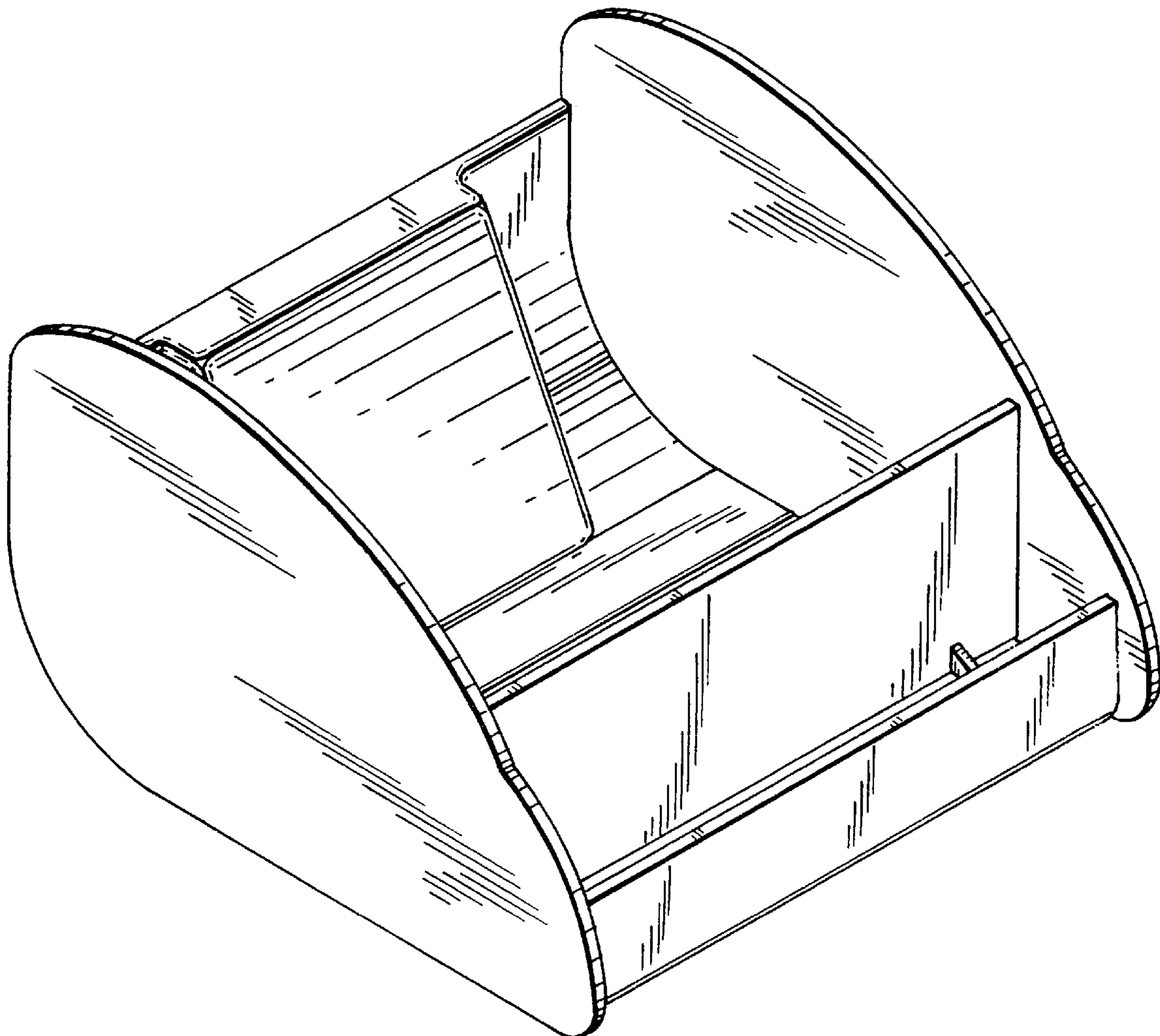
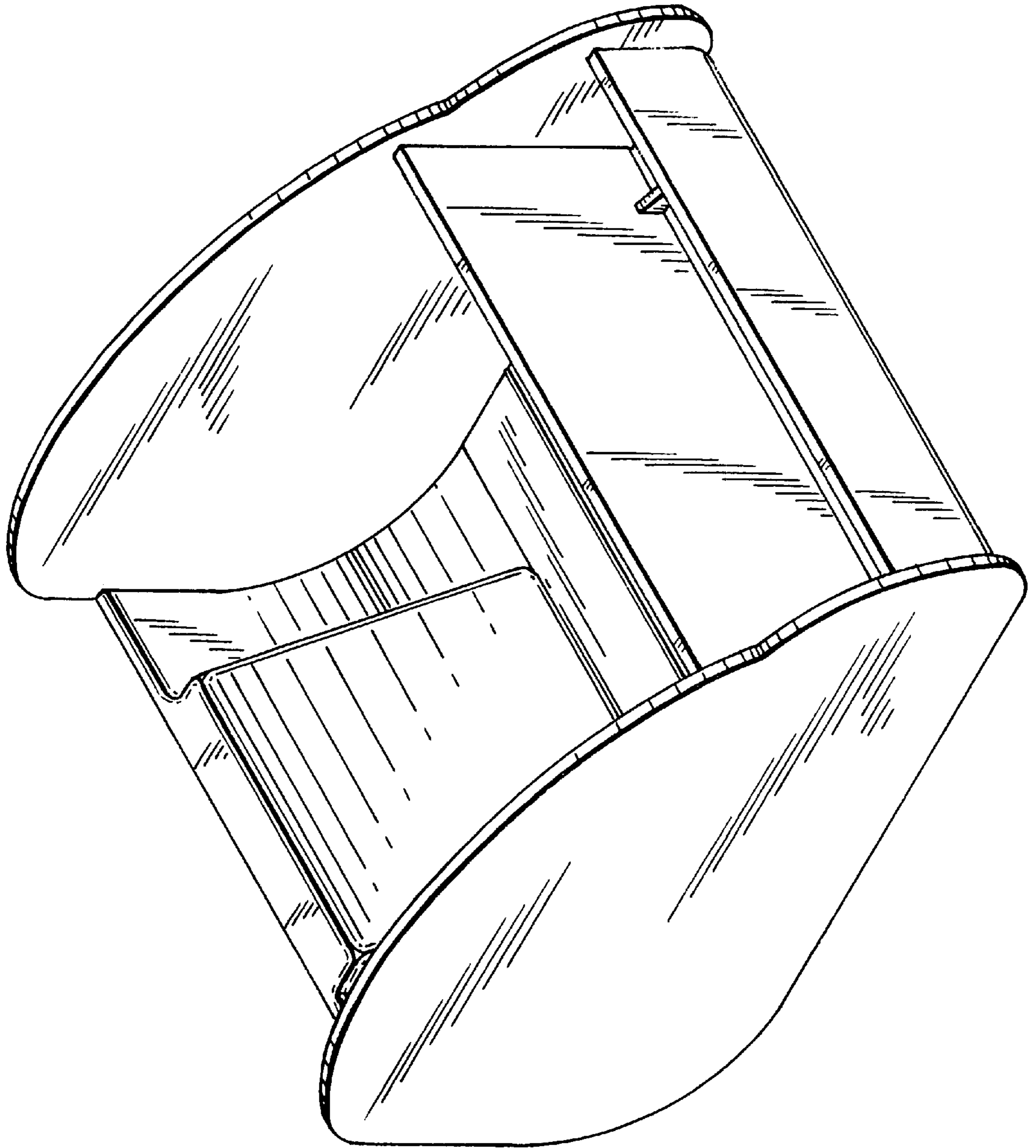

FIG. 1



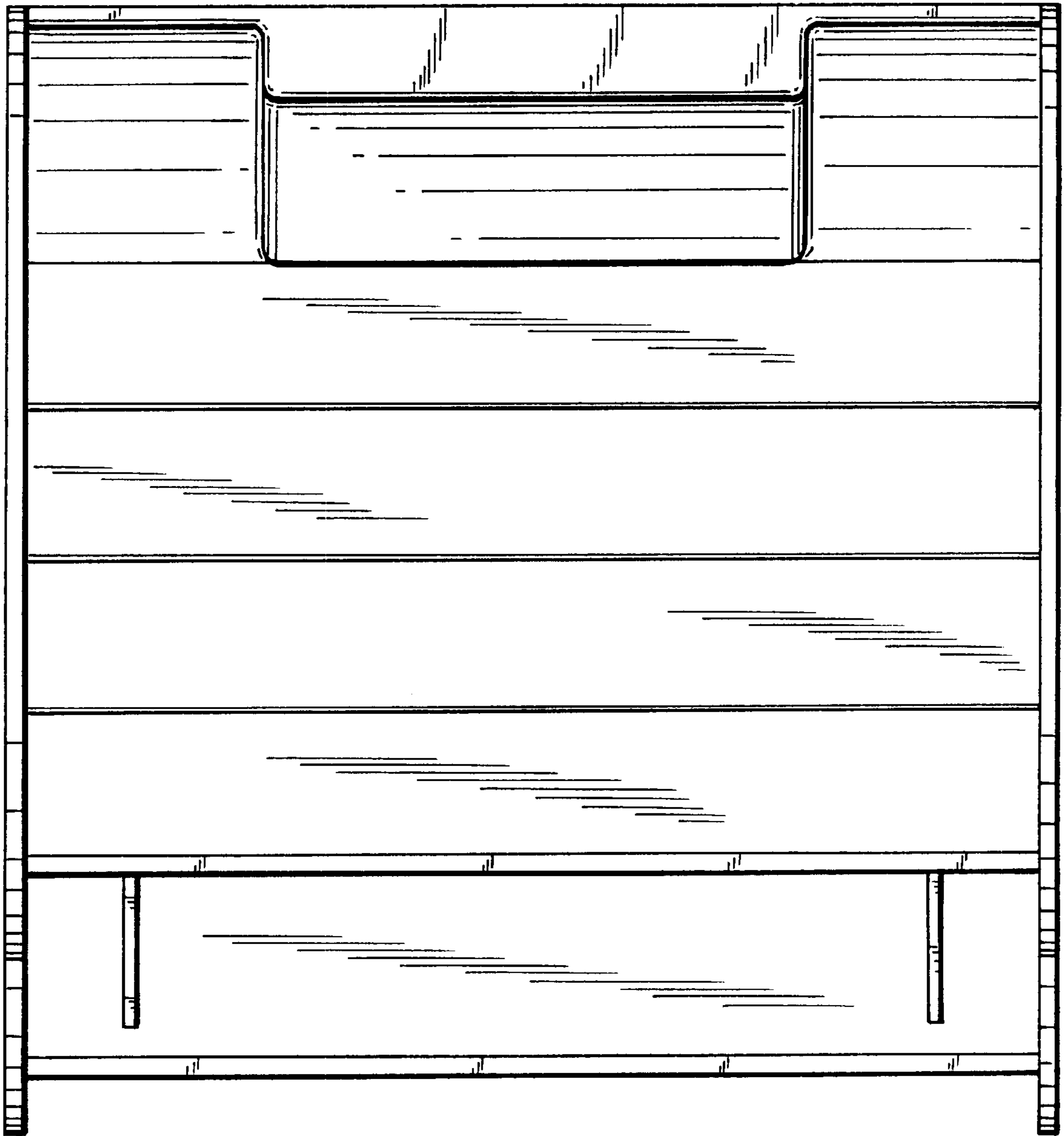

FIG. 2

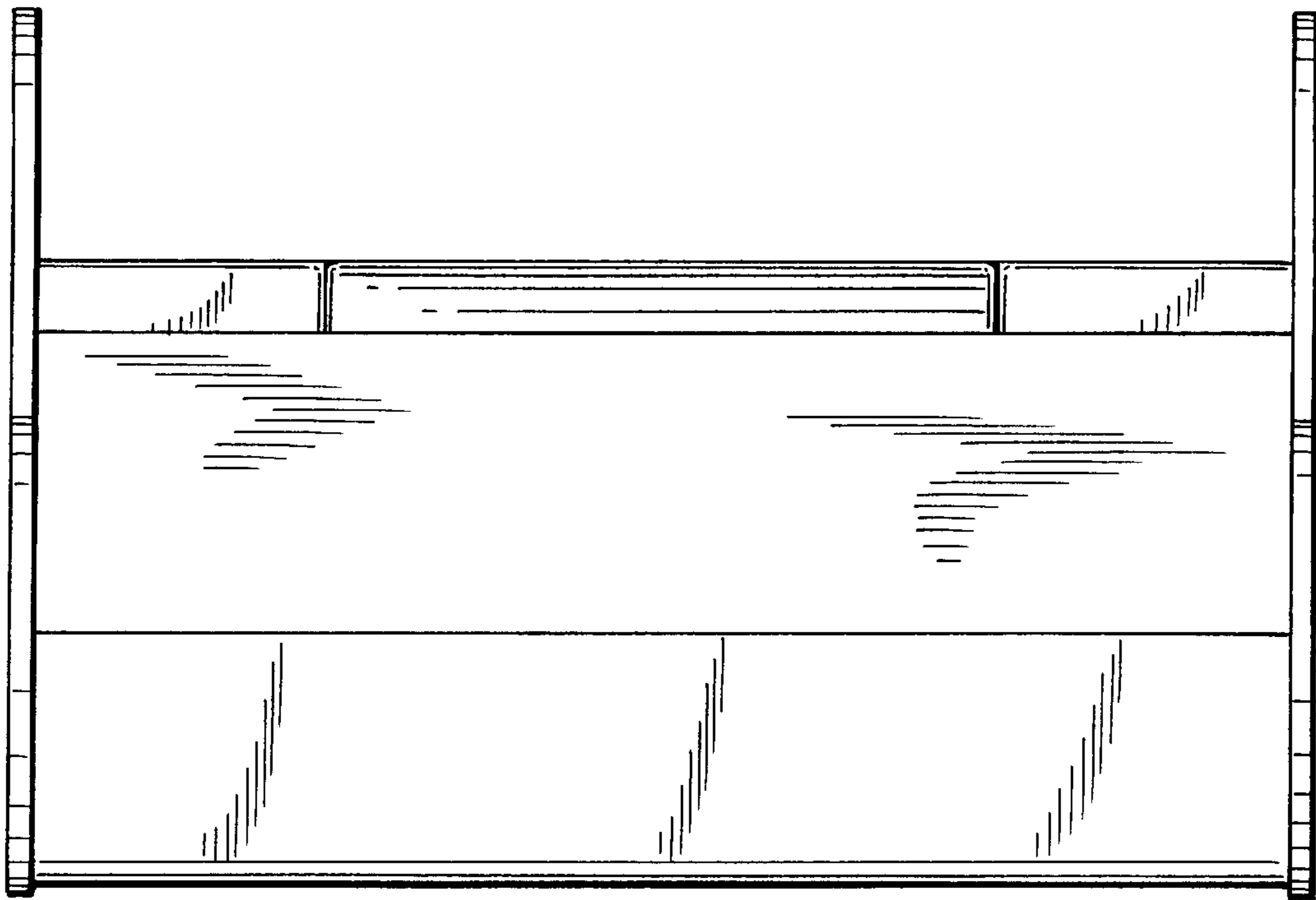

FIG. 3

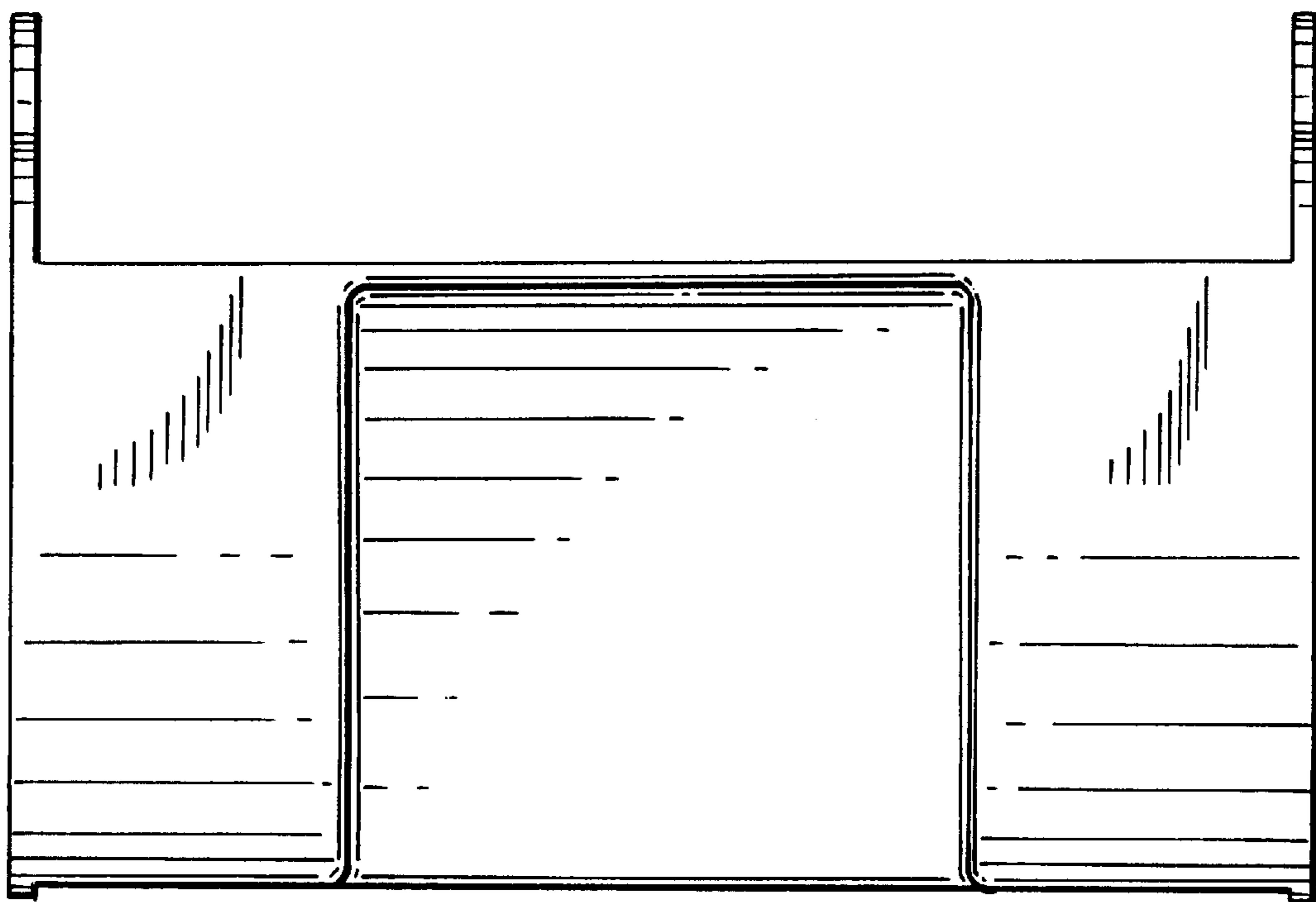

FIG. 5

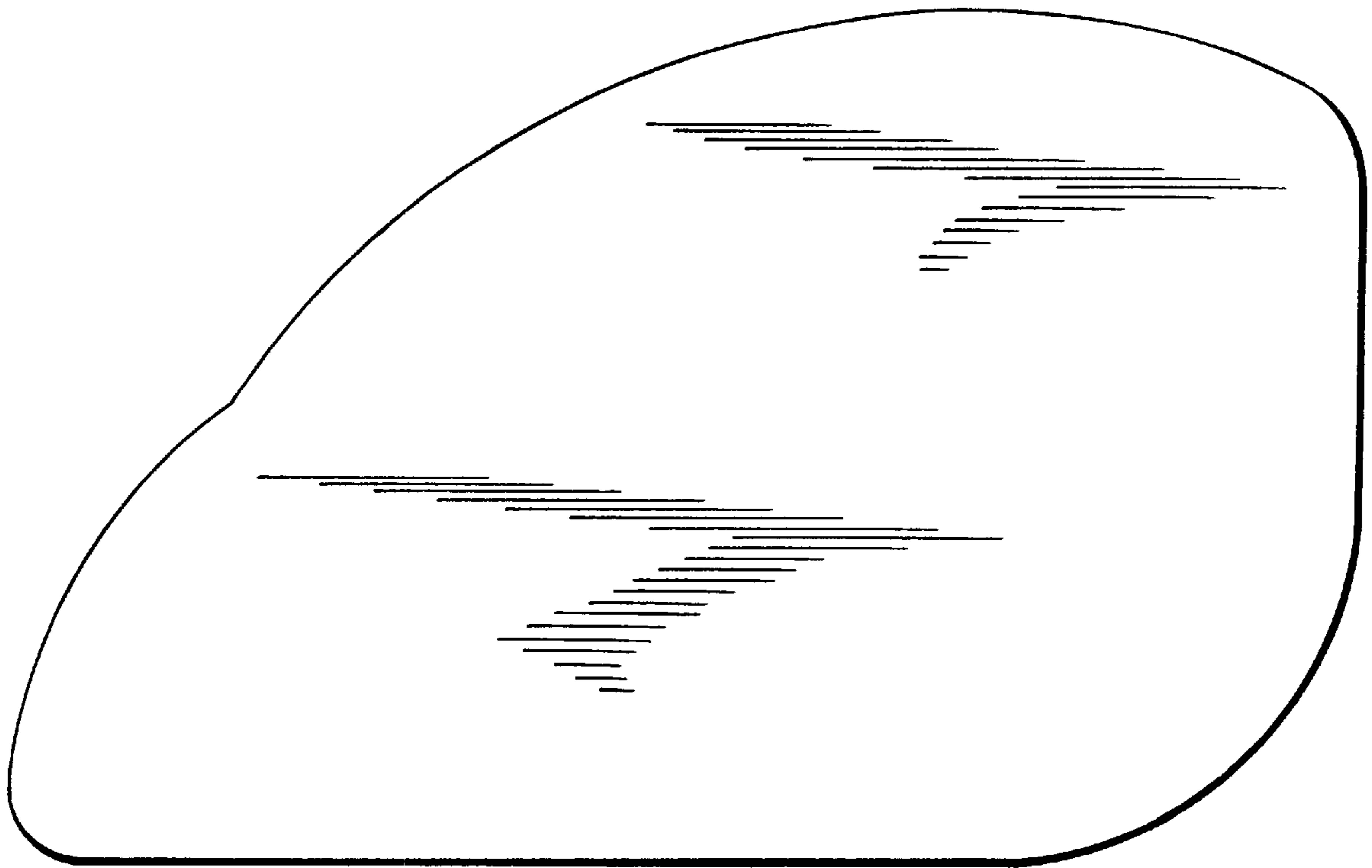

FIG. 4

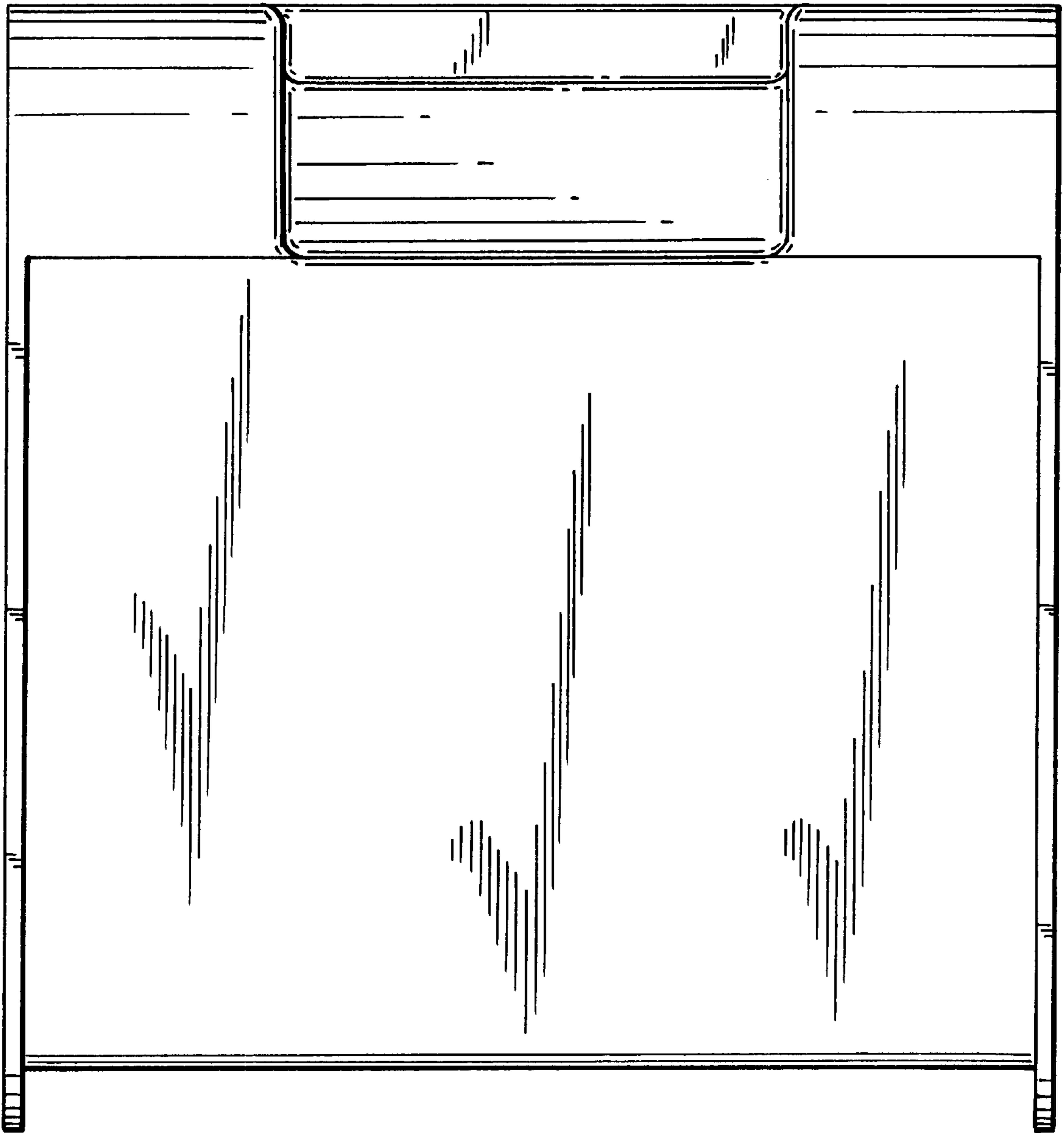

FIG. 6