



US00D432161S

# United States Patent [19] Takeuchi

[11] **Patent Number: Des. 432,161**

[45] **Date of Patent: \*\* Oct. 17, 2000**

[54] **PHOTOCOPIER**

[75] Inventor: **Motoaki Takeuchi**, Tokyo, Japan

[73] Assignee: **Canon Kabushiki Kaisha**, Tokyo, Japan

[\*\*] Term: **14 Years**

[21] Appl. No.: **29/112,656**

[22] Filed: **Oct. 22, 1999**

[30] **Foreign Application Priority Data**

Apr. 27, 1999 [JP] Japan ..... 11-11232

[51] **LOC (7) Cl.** ..... **16-03**

[52] **U.S. Cl.** ..... **D18/39**

[58] **Field of Search** ..... D18/36-39; 399/1-7,  
399/75, 81, 130, 151, 411

[56] **References Cited**

**U.S. PATENT DOCUMENTS**

D. 339,152 9/1993 Hirose et al. .... D18/39

D. 378,925 4/1997 Komatsu ..... D18/38  
D. 380,006 6/1997 Takahashi et al. .... D18/39  
D. 399,250 10/1998 Kawai ..... D18/50  
D. 404,418 1/1999 Takeuchi ..... D18/39

*Primary Examiner*—Caron D. Veynar  
*Attorney, Agent, or Firm*—Fitzpatrick, Cella, Harper & Scinto

[57] **CLAIM**

The ornamental design for a photocopier, as shown and described.

**DESCRIPTION**

FIG. 1 is a front view of a photocopier showing my new design;  
FIG. 2 is a rear view thereof;  
FIG. 3 is a top plan view thereof;  
FIG. 4 is a bottom plan view thereof;  
FIG. 5 is a left side view thereof;  
FIG. 6 is a right side view thereof; and,  
FIG. 7 is a perspective view thereof.

**1 Claim, 5 Drawing Sheets**

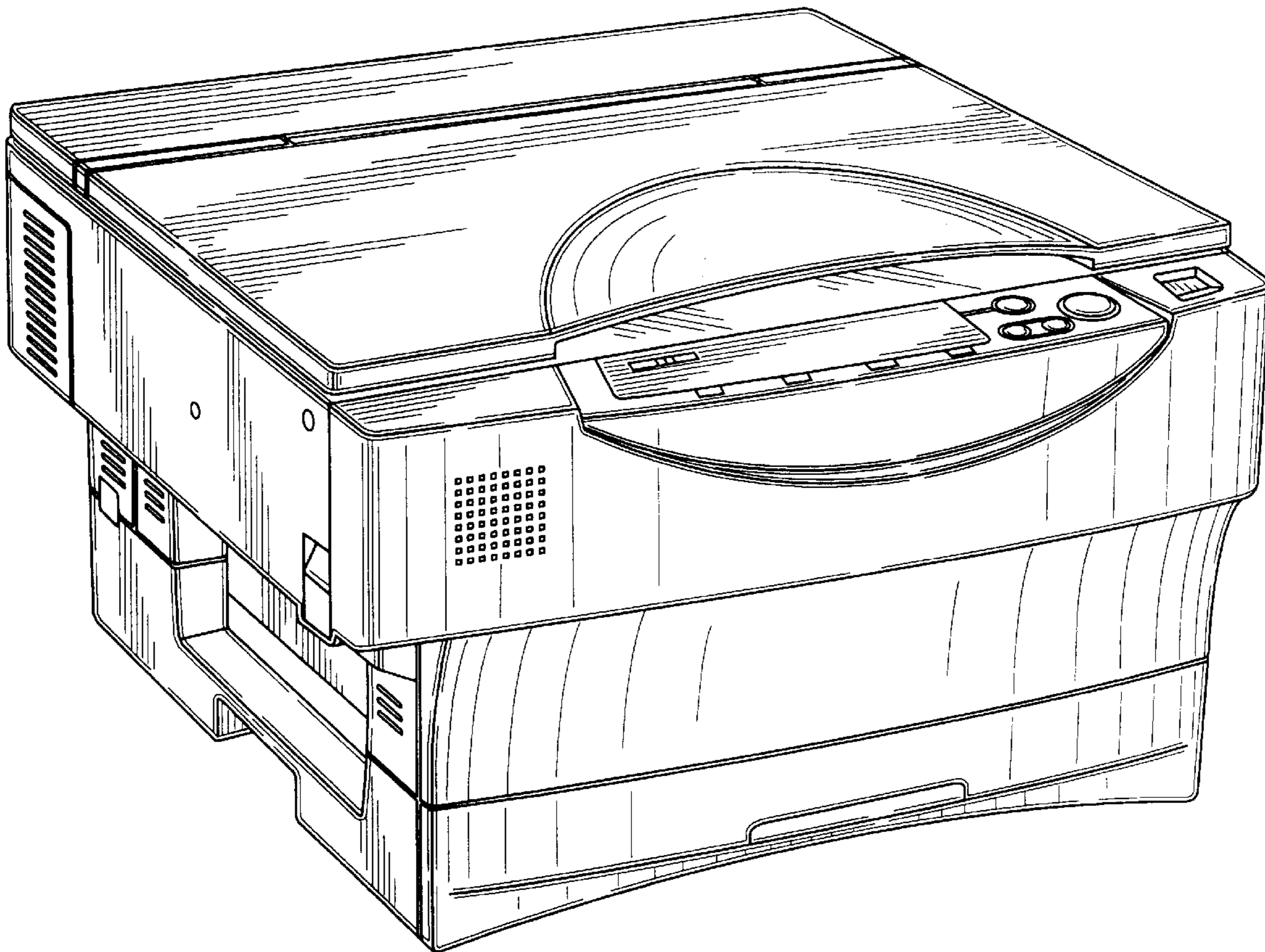

*FIG. 1*

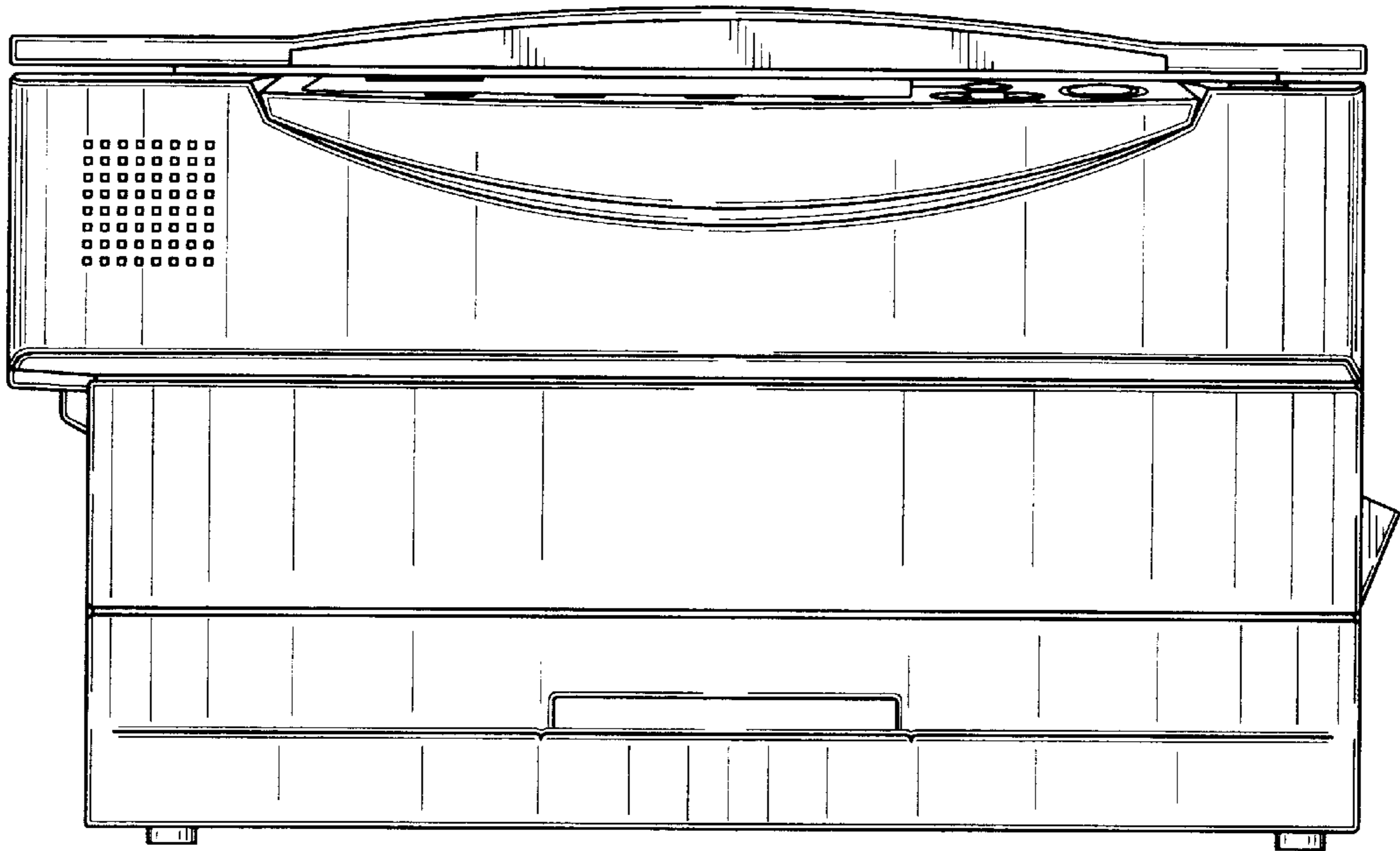

*FIG. 2*

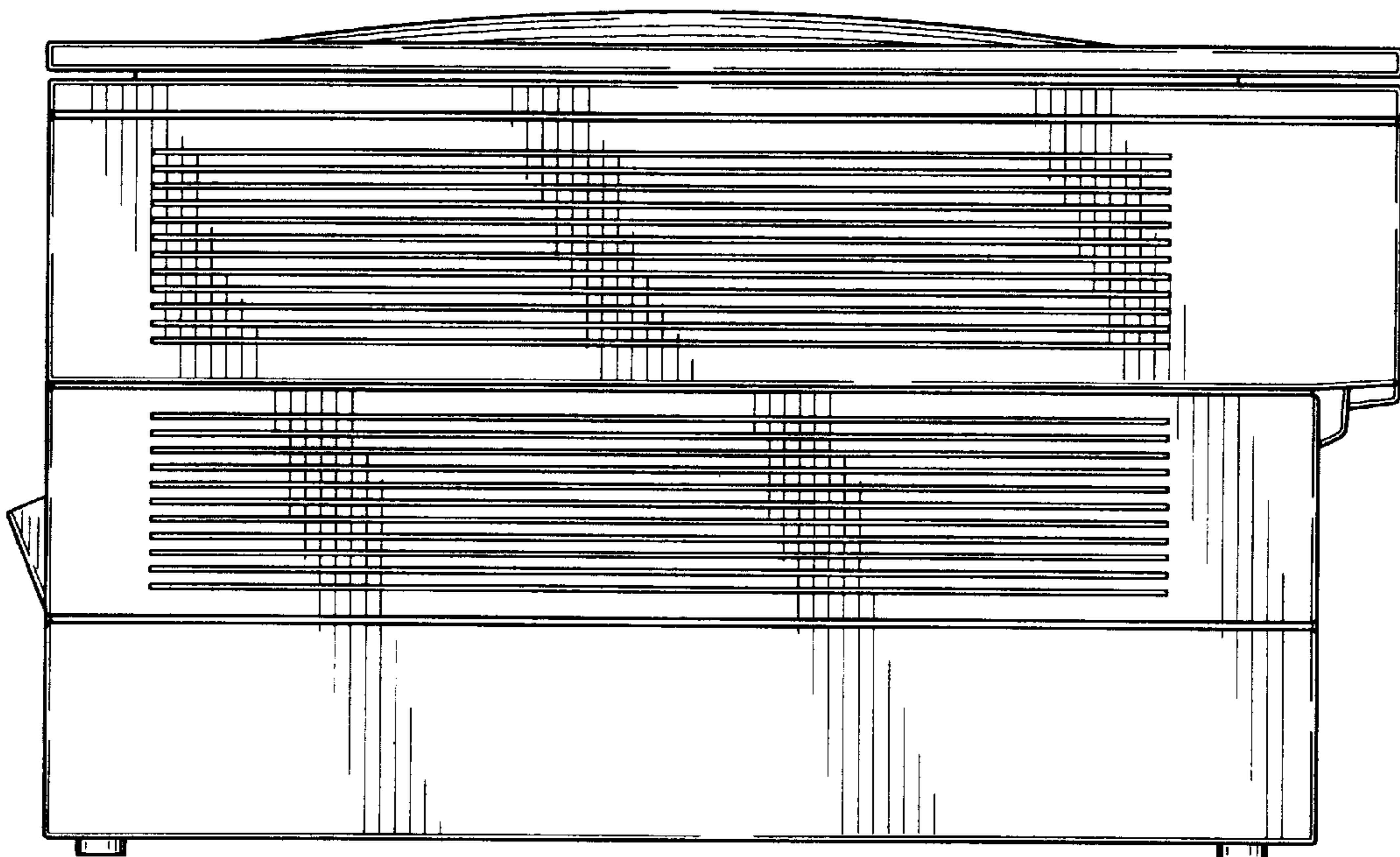

*FIG. 3*

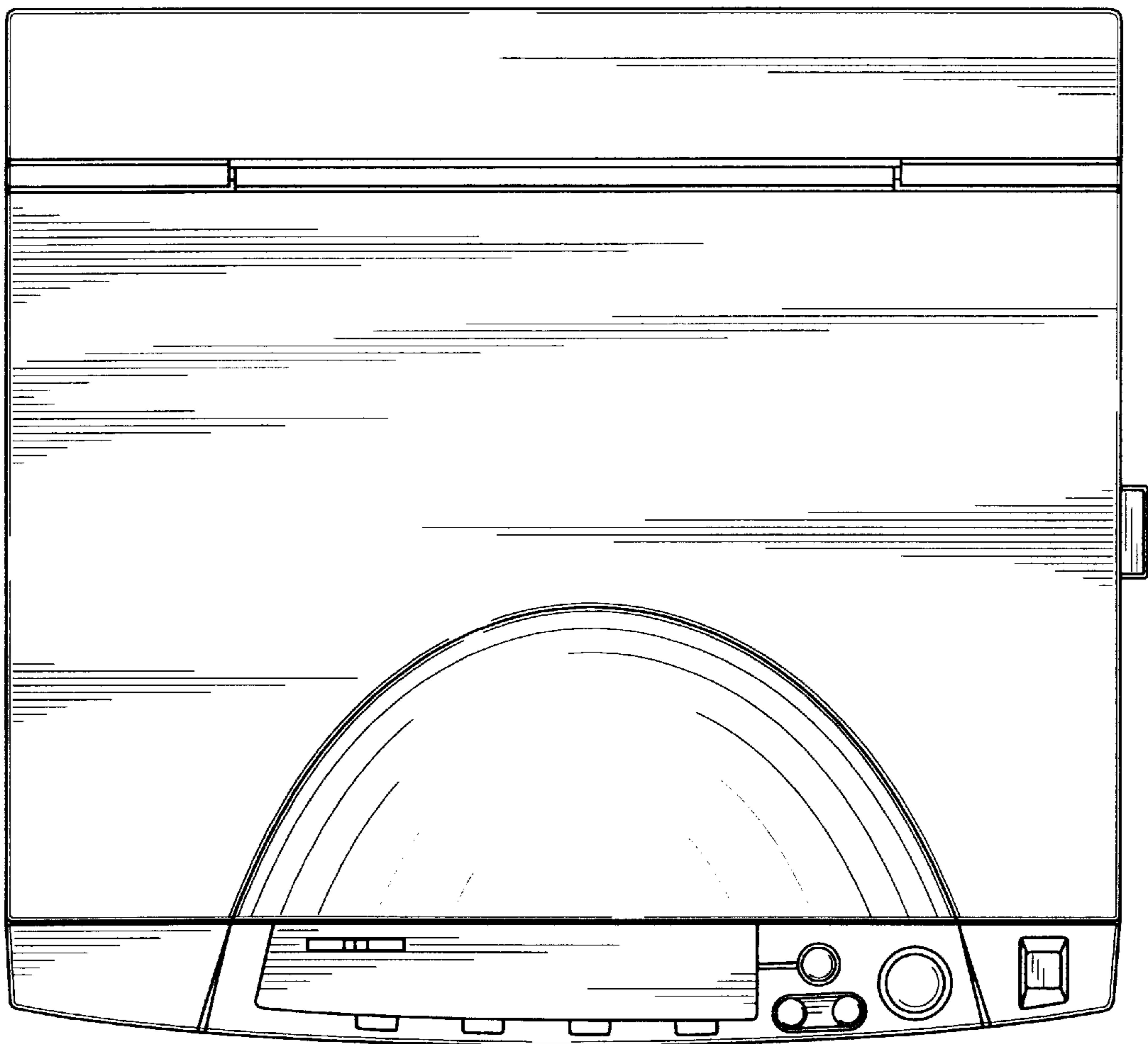

*FIG. 4*

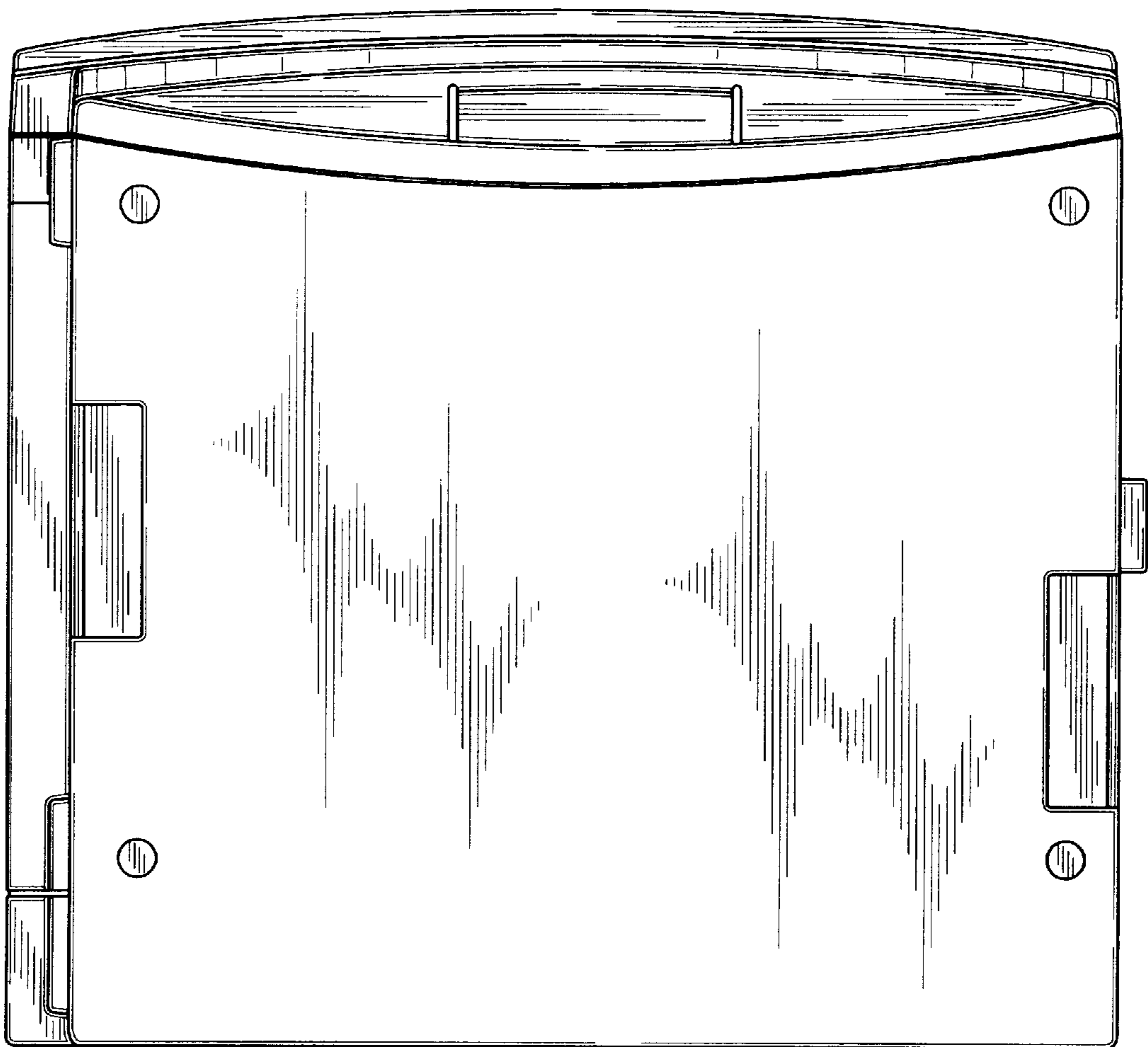

*FIG. 5*

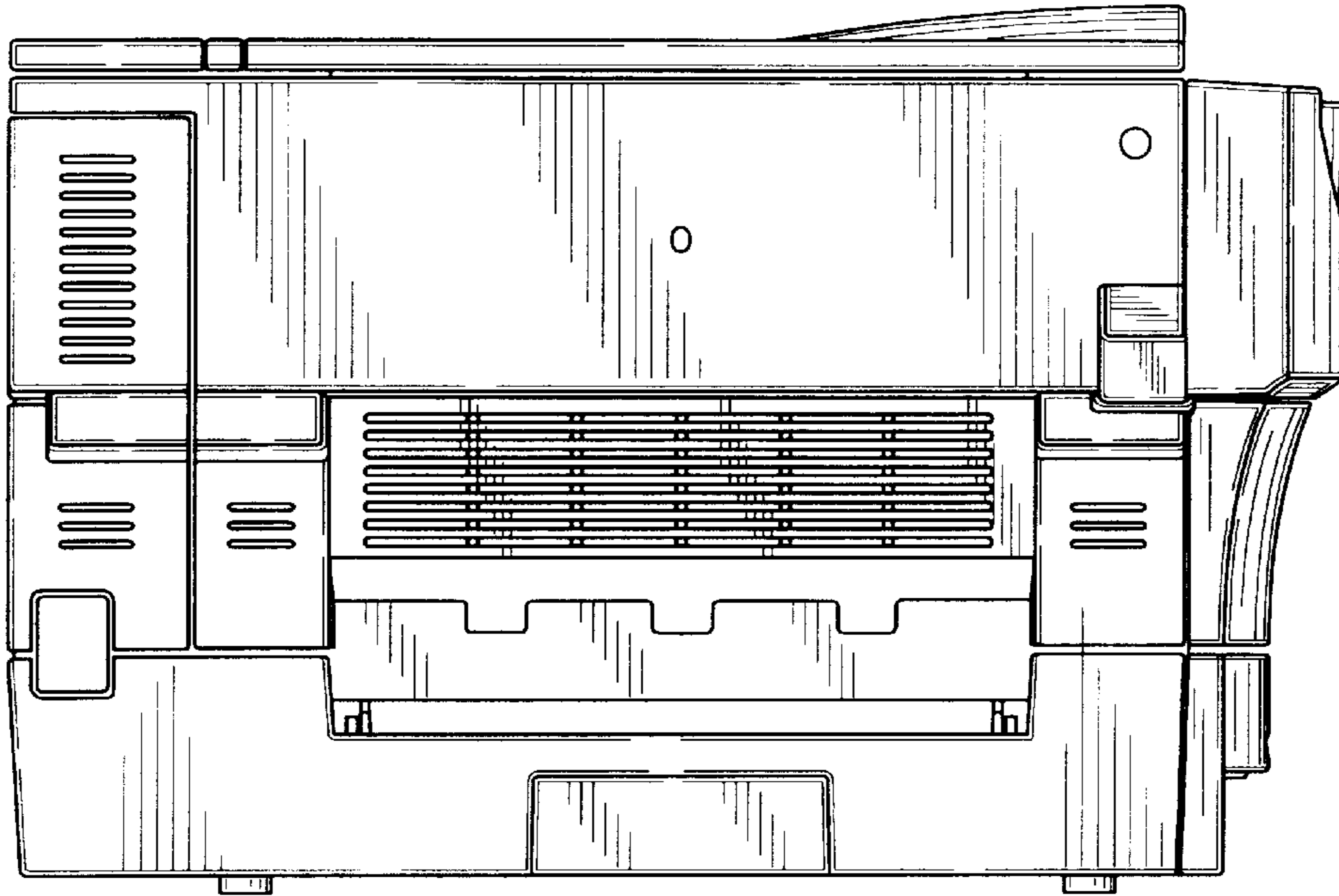

*FIG. 6*

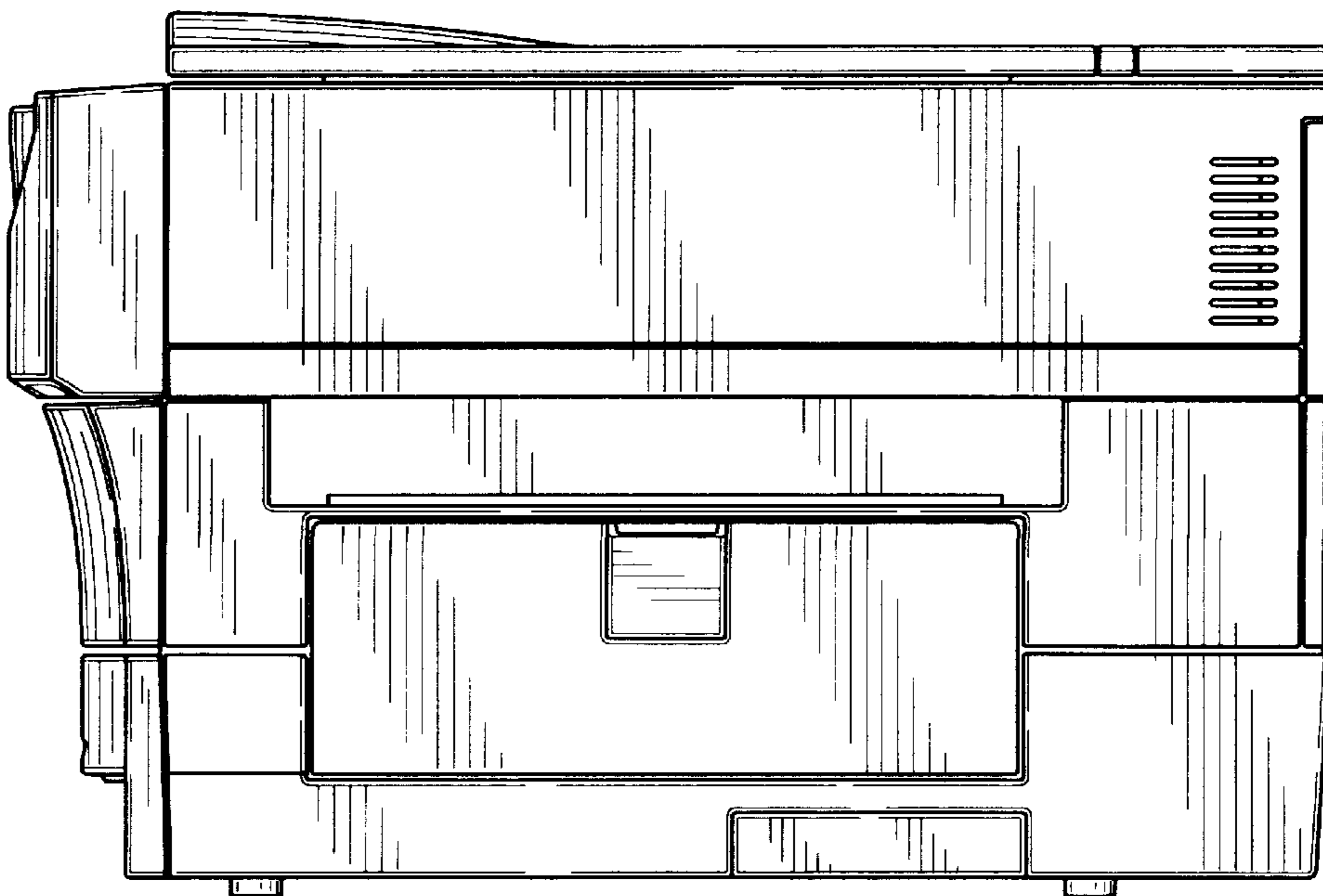



FIG. 7

