



US00D432136S

United States Patent [19]

[11] Patent Number: Des. 432,136

Jean et al.

[45] Date of Patent: ** Oct. 17, 2000

[54] **COMPUTER FRONT BEZEL**

Attorney, Agent, or Firm—Wei Te Chung

[75] Inventors: **Paul Jean; Kaven Kan**, both of
Tau-Yuan; **Ying Sheng Yih**, Taipei, all
of Taiwan

[57] **CLAIM**

The ornamental design for a computer front bezel, as shown
and described.

[73] Assignee: **Hon Hai Precision Ind. Co., Ltd.**,
Taipei Hsien, Taiwan

DESCRIPTION

[**] Term: **14 Years**

FIG. 1 is a perspective view of a computer front bezel showing a first embodiment of our new design; FIG. 2 is a front elevational view thereof; FIG. 3 is a rear elevational view thereof; FIG. 4 is a left side elevational view thereof; FIG. 5 is a right side elevational view thereof; FIG. 6 is a top plan view thereof; FIG. 7 is a bottom plan view thereof; FIG. 8 is a perspective view thereof shown attached to a computer which is shown in broken lines for illustrative purposes only and forms no part of the claimed design; FIG. 9 is a perspective view of a computer front bezel showing a second embodiment of our new design; FIG. 10 is a front elevational view thereof; FIG. 11 is a rear elevational view thereof; FIG. 12 is a left side elevational view thereof; FIG. 13 is a right side elevational view thereof; FIG. 14 is a top plan view thereof; FIG. 15 is a bottom plan view thereof; and, FIG. 16 is a perspective view thereof shown attached to a computer which is shown in broken lines for illustrative purposes only and forms no part of the claimed design.

[21] Appl. No.: **29/113,773**

[22] Filed: **Nov. 9, 1999**

[30] **Foreign Application Priority Data**

Aug. 6, 1999 [TW] Taiwan 88305161
Aug. 10, 1999 [TW] Taiwan 88305208

[51] **LOC (7) Cl.** **14-02**

[52] **U.S. Cl.** **D14/444**

[58] **Field of Search** D14/441, 444,
D14/446; D10/103; D13/162, 184, 164,
177, 199; 312/223.2; 361/600, 622, 724,
728

[56] **References Cited**

U.S. PATENT DOCUMENTS

D. 413,321 8/1999 Su D14/441
D. 413,878 9/1999 Jean et al. D14/441
D. 415,141 8/1999 Jean et al. D14/441

Primary Examiner—Freda Nunn

1 Claim, 12 Drawing Sheets

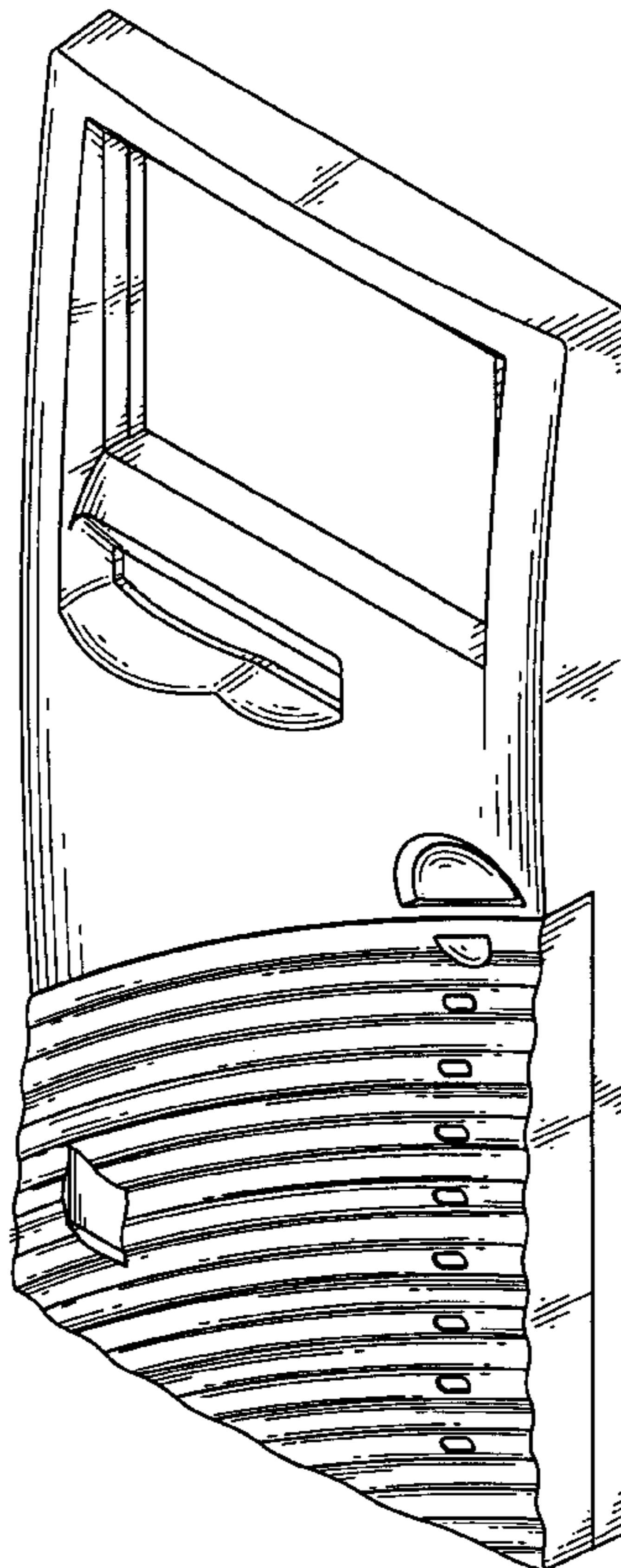

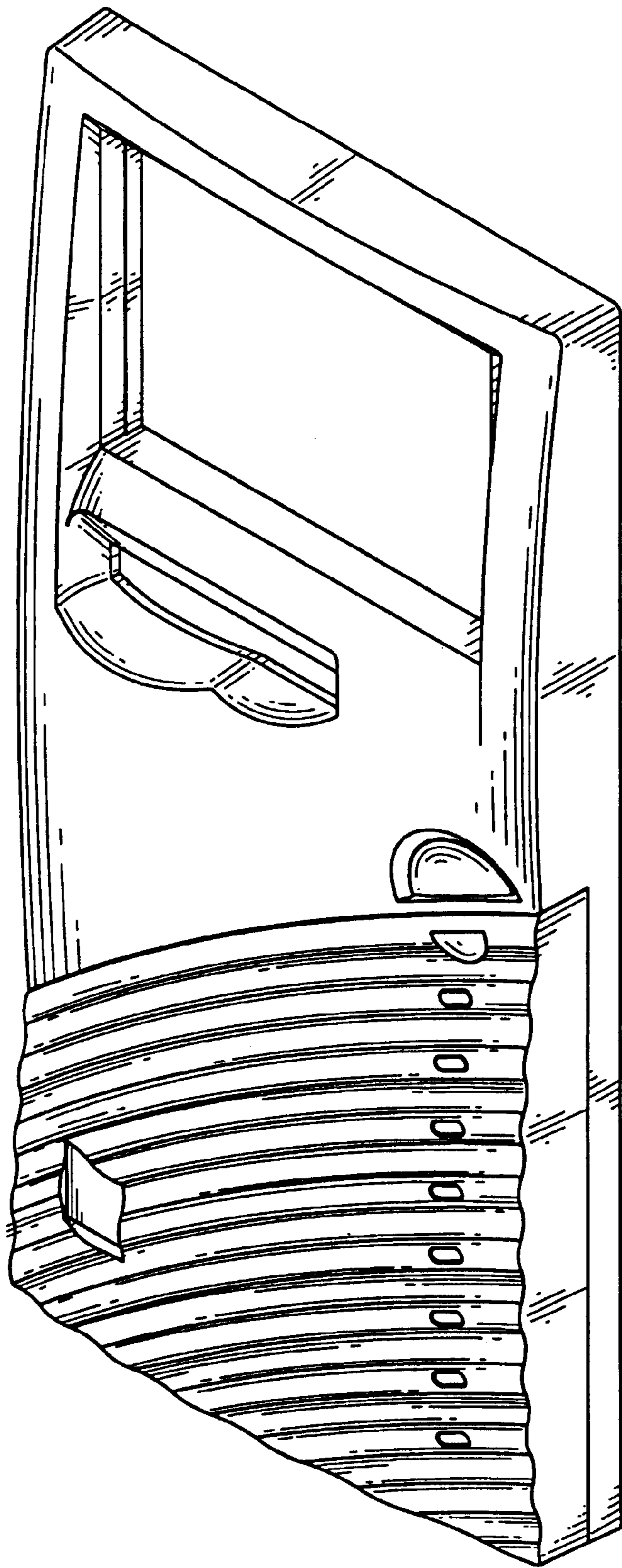

FIG. 1

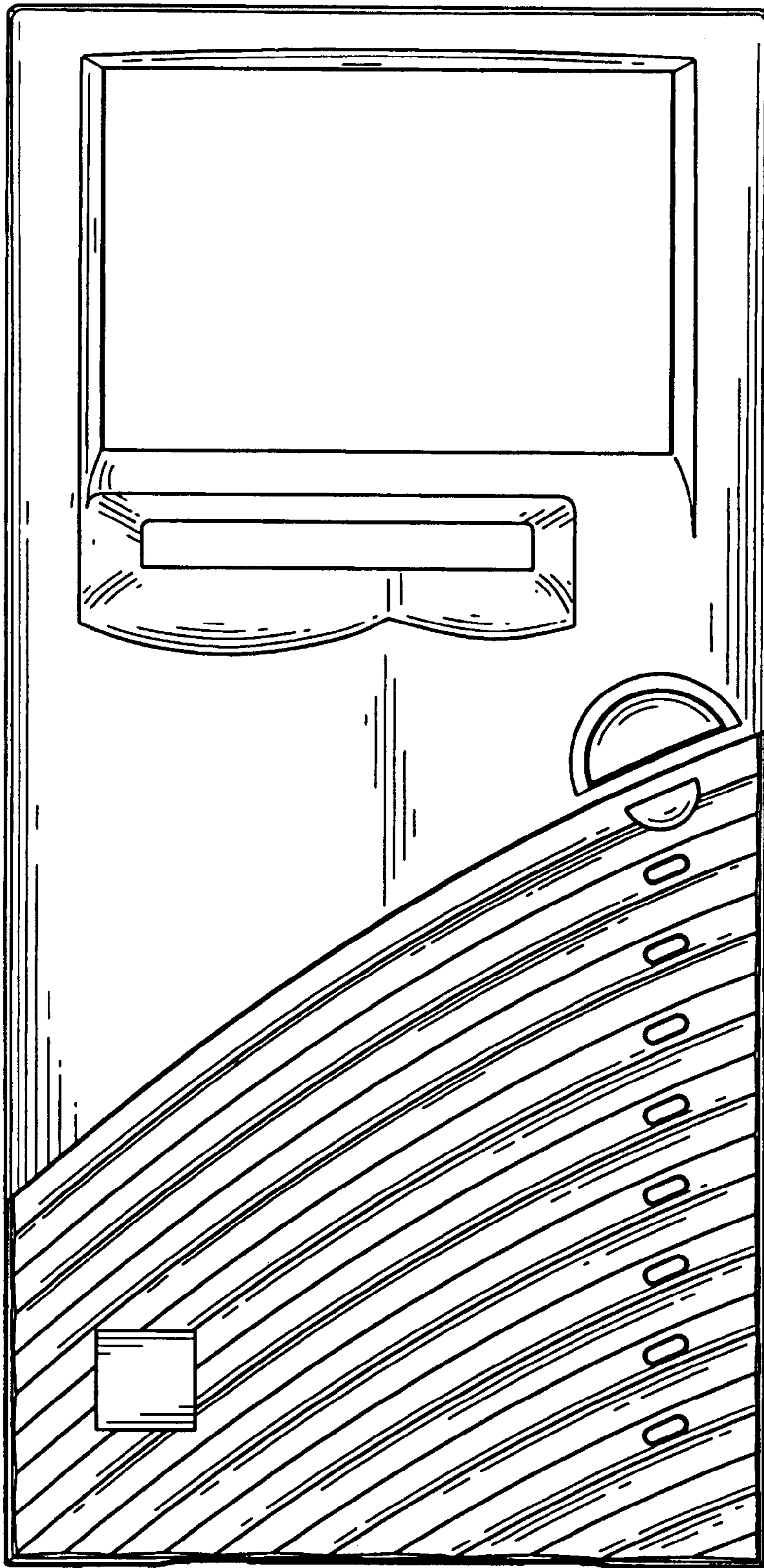

FIG. 2

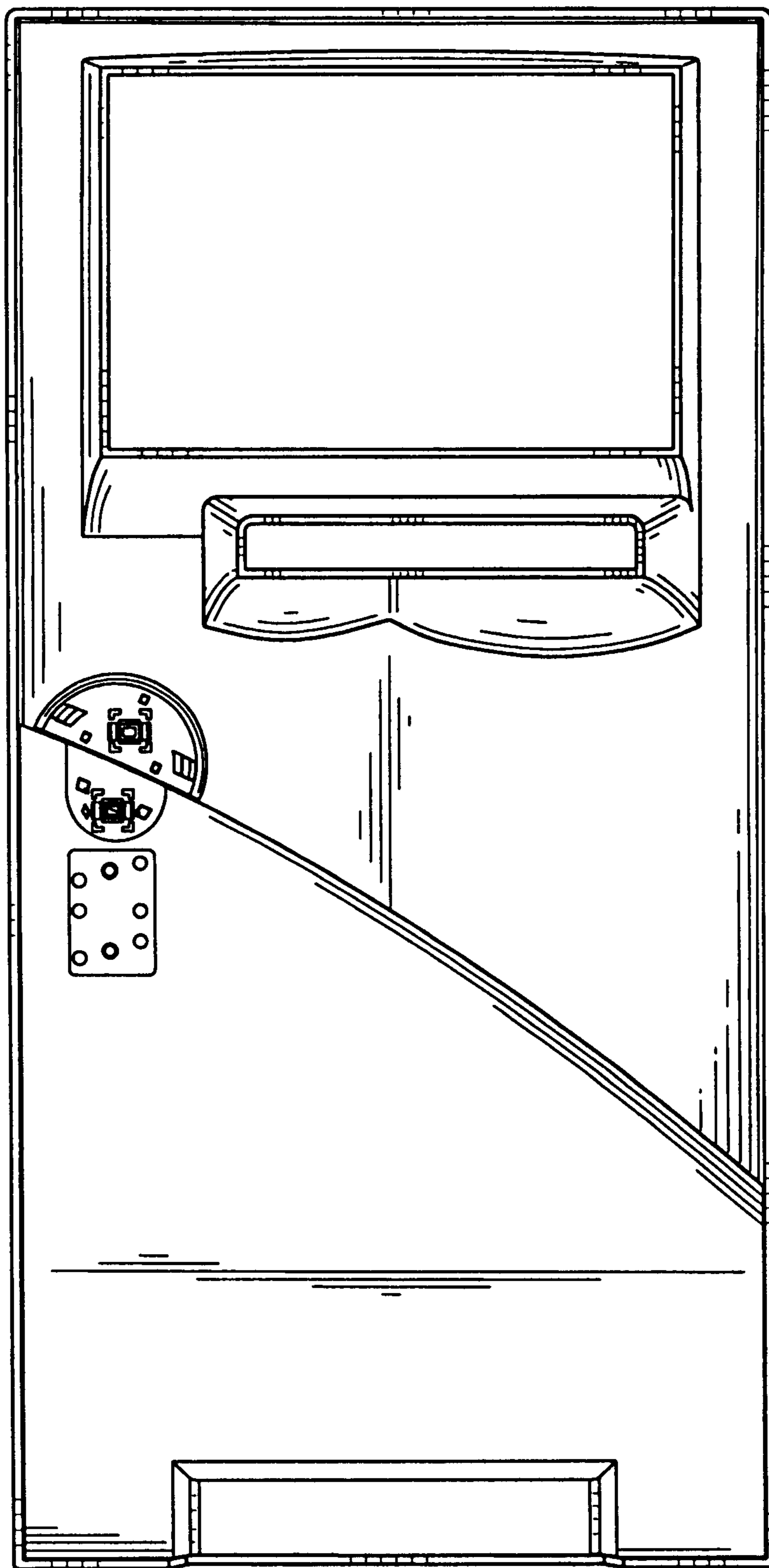

FIG. 3

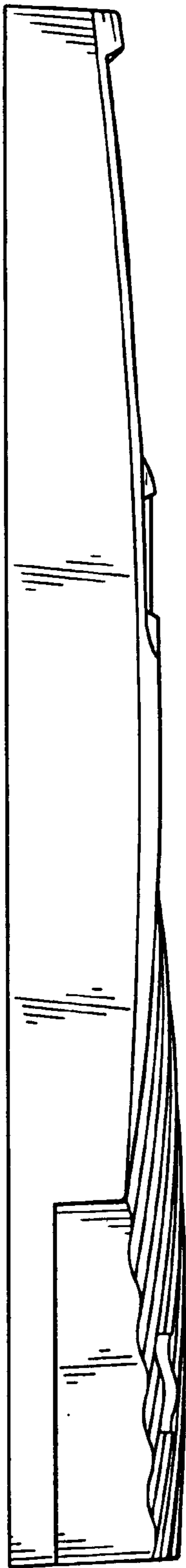

FIG. 4

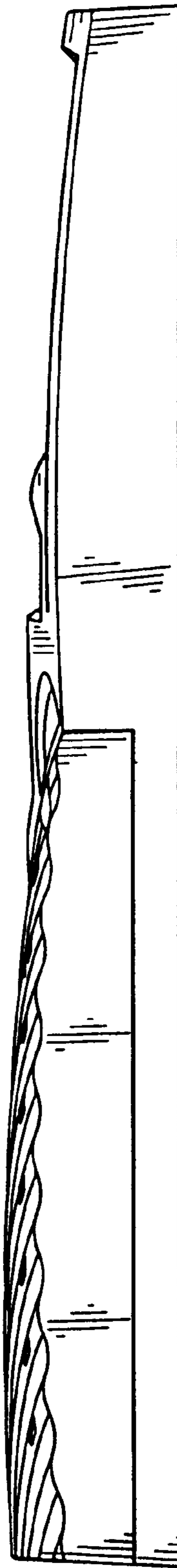

FIG. 5

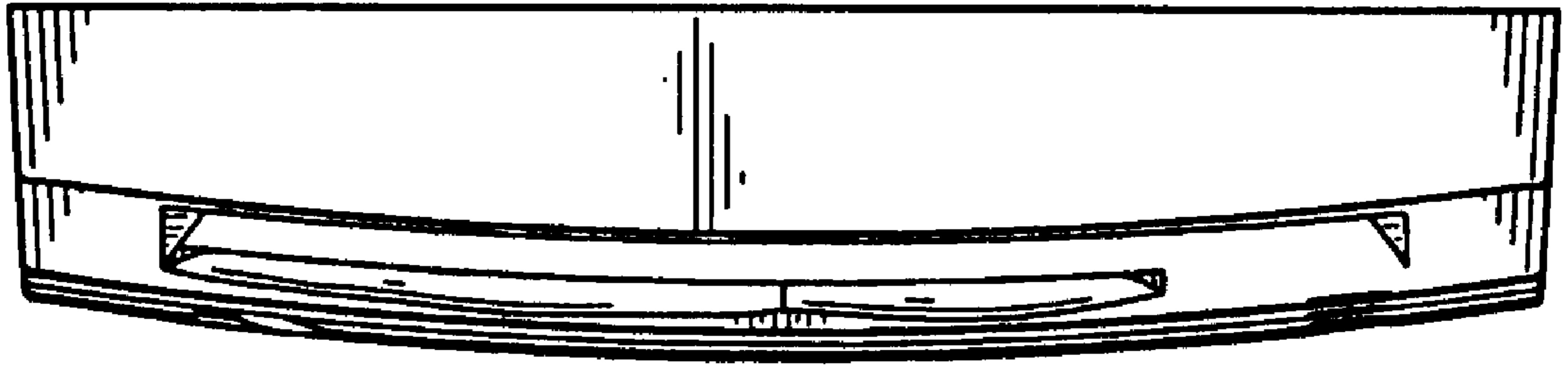

FIG. 6

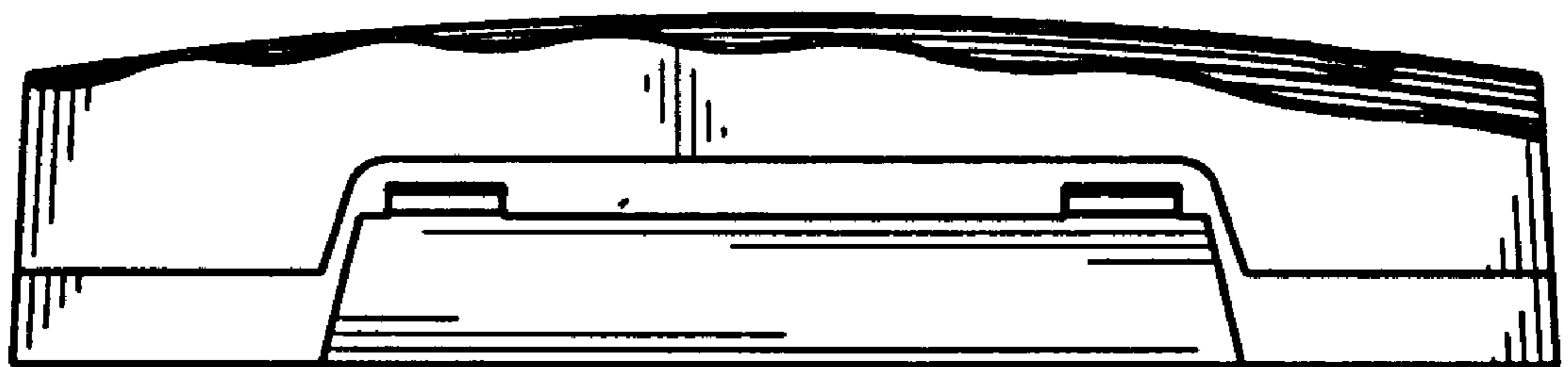

FIG. 7

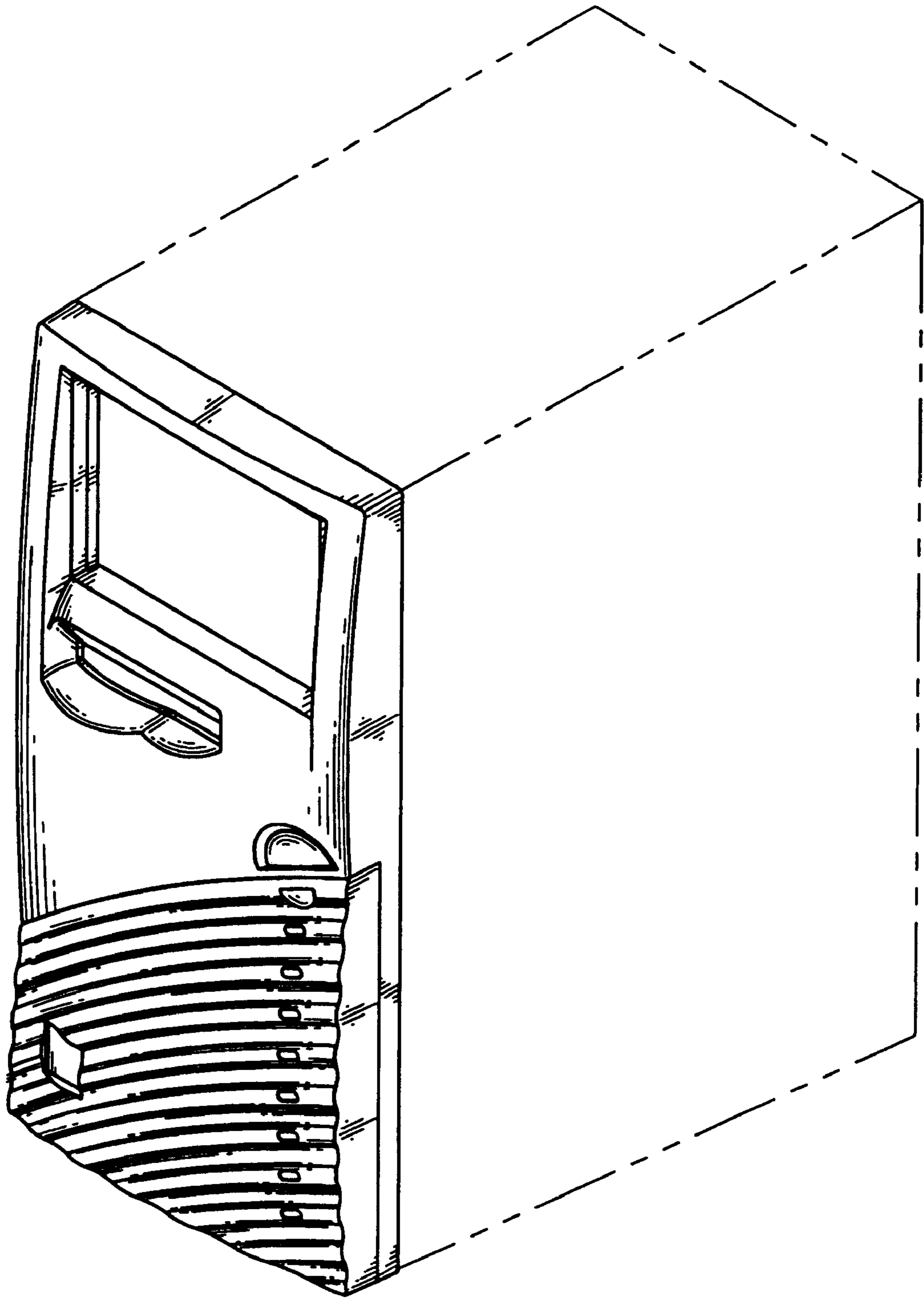

FIG. 8

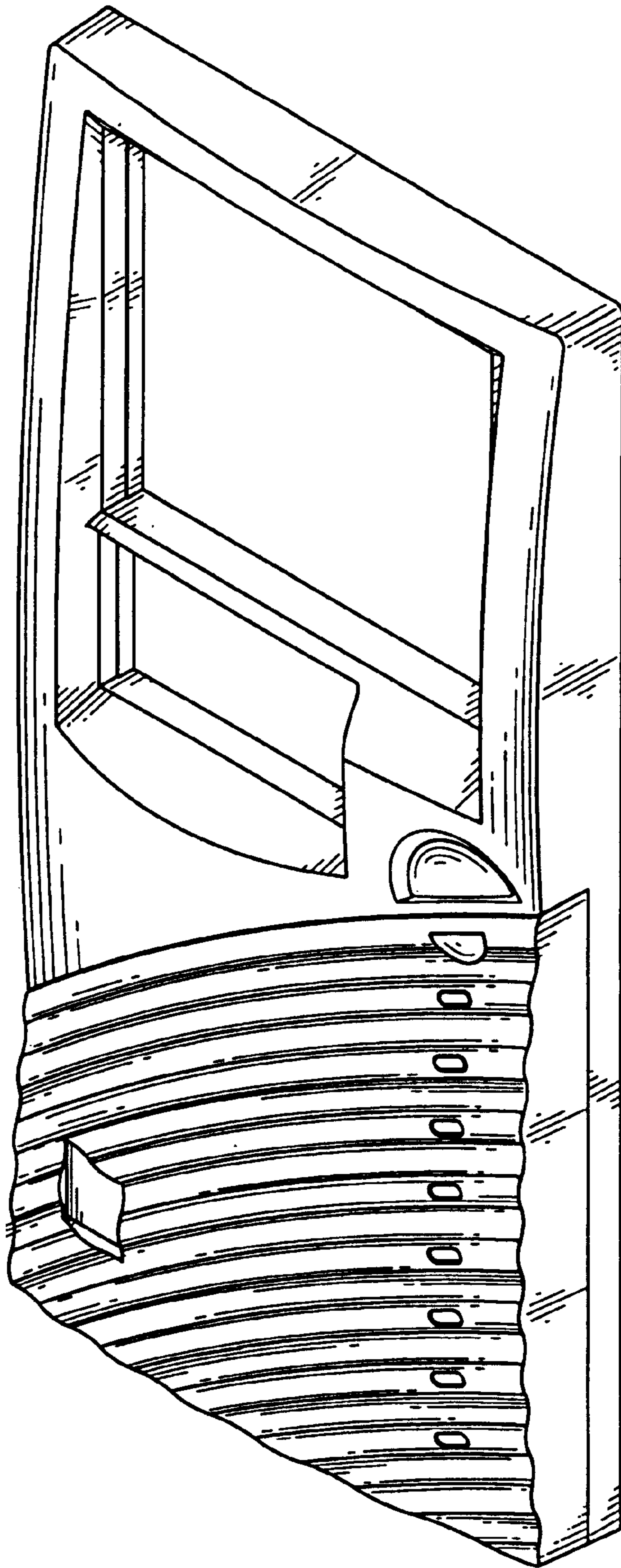

FIG. 9

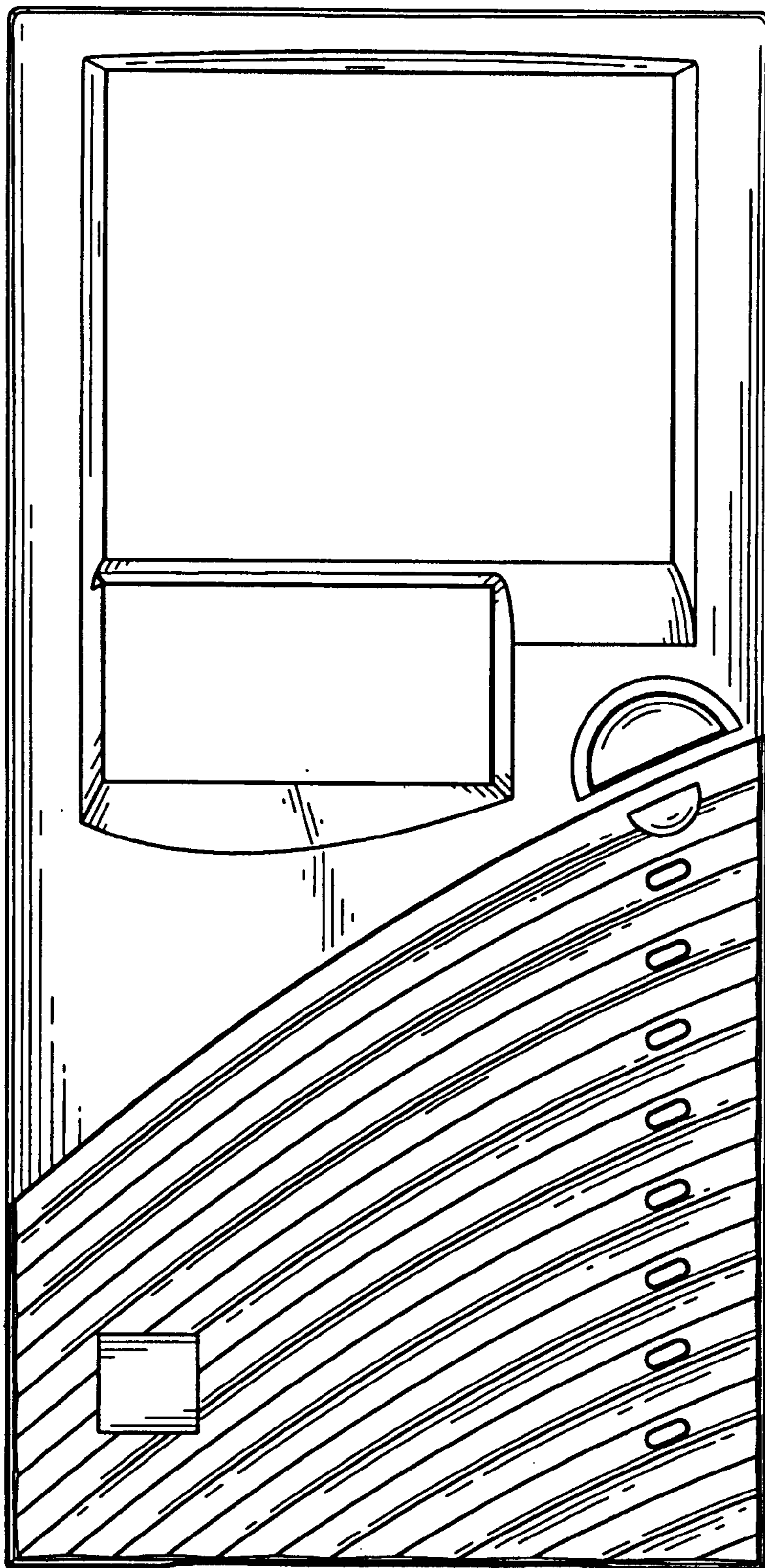

FIG. 10

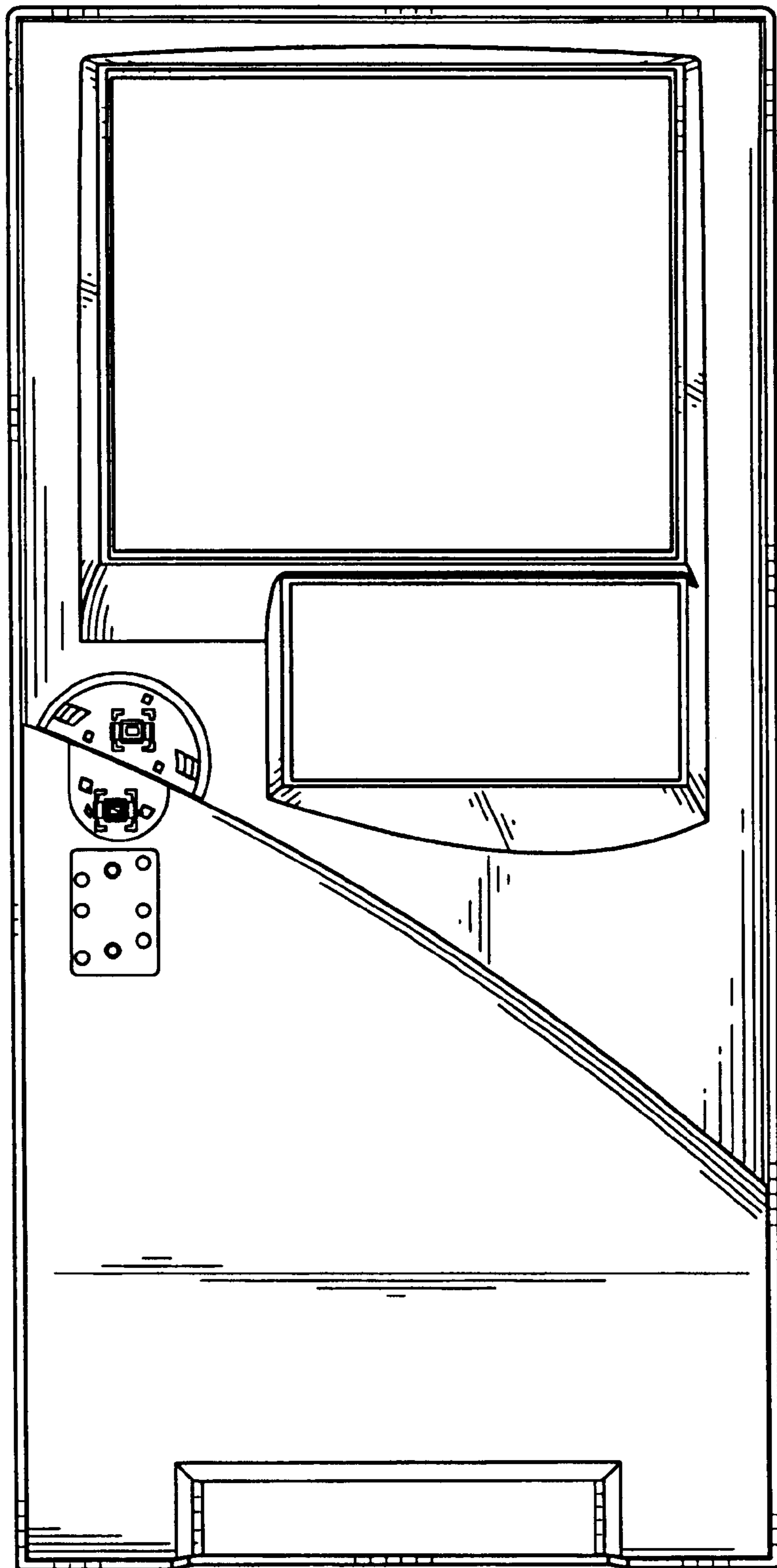

FIG. 11

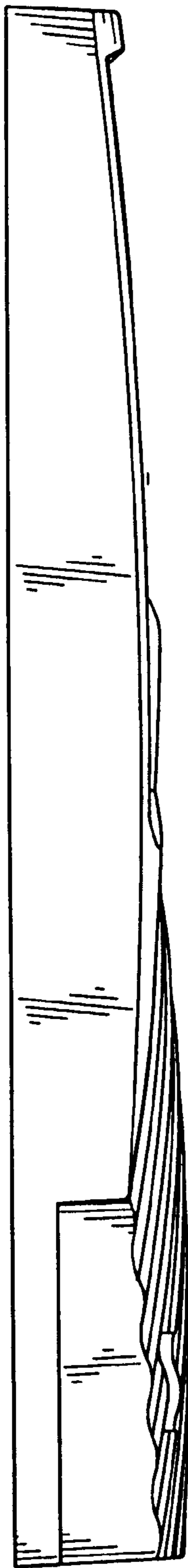

FIG. 12

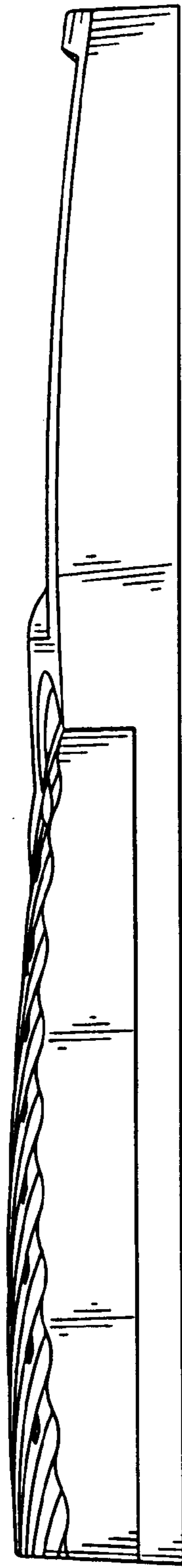

FIG. 13

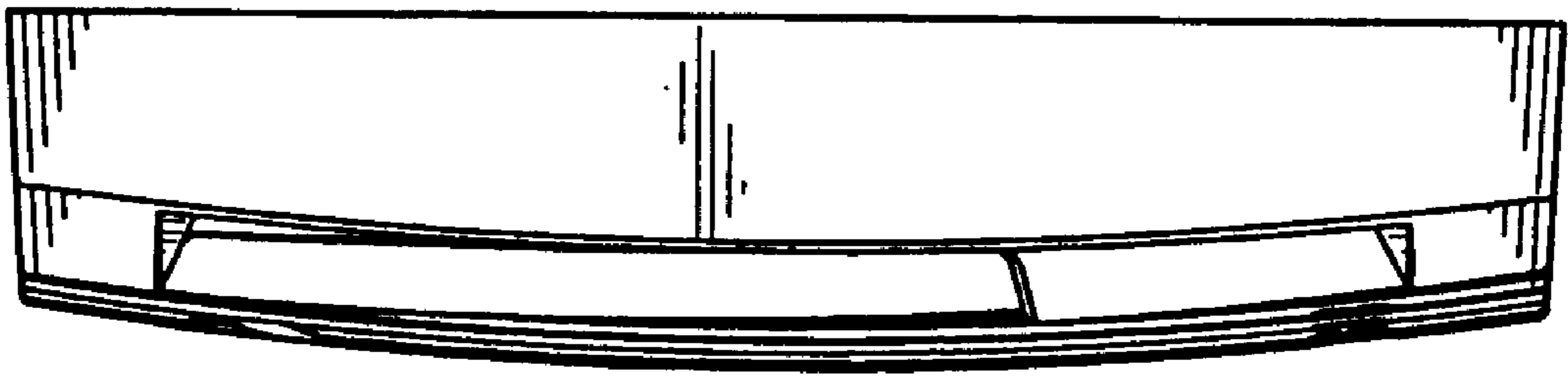

FIG. 14

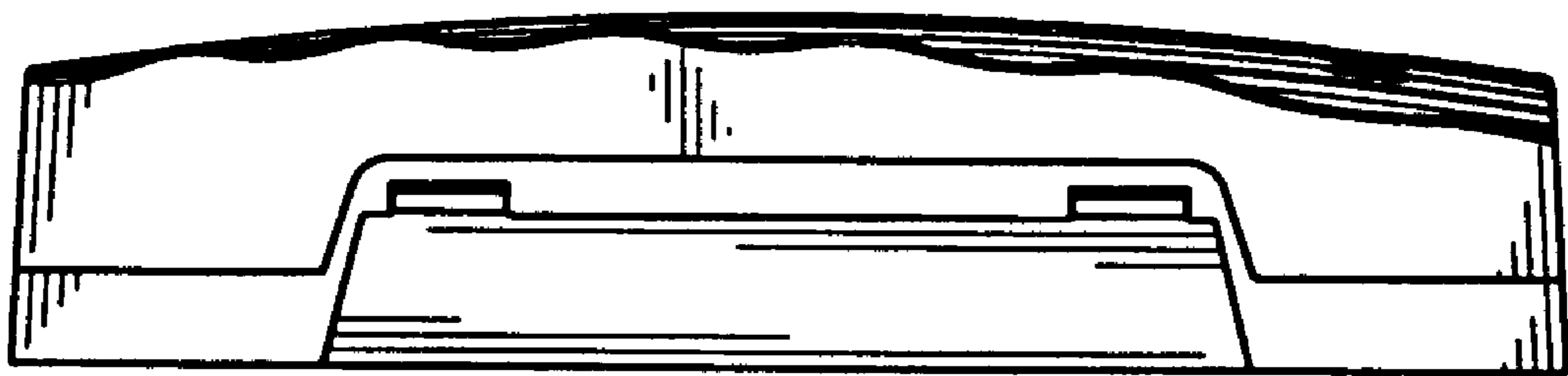

FIG. 15

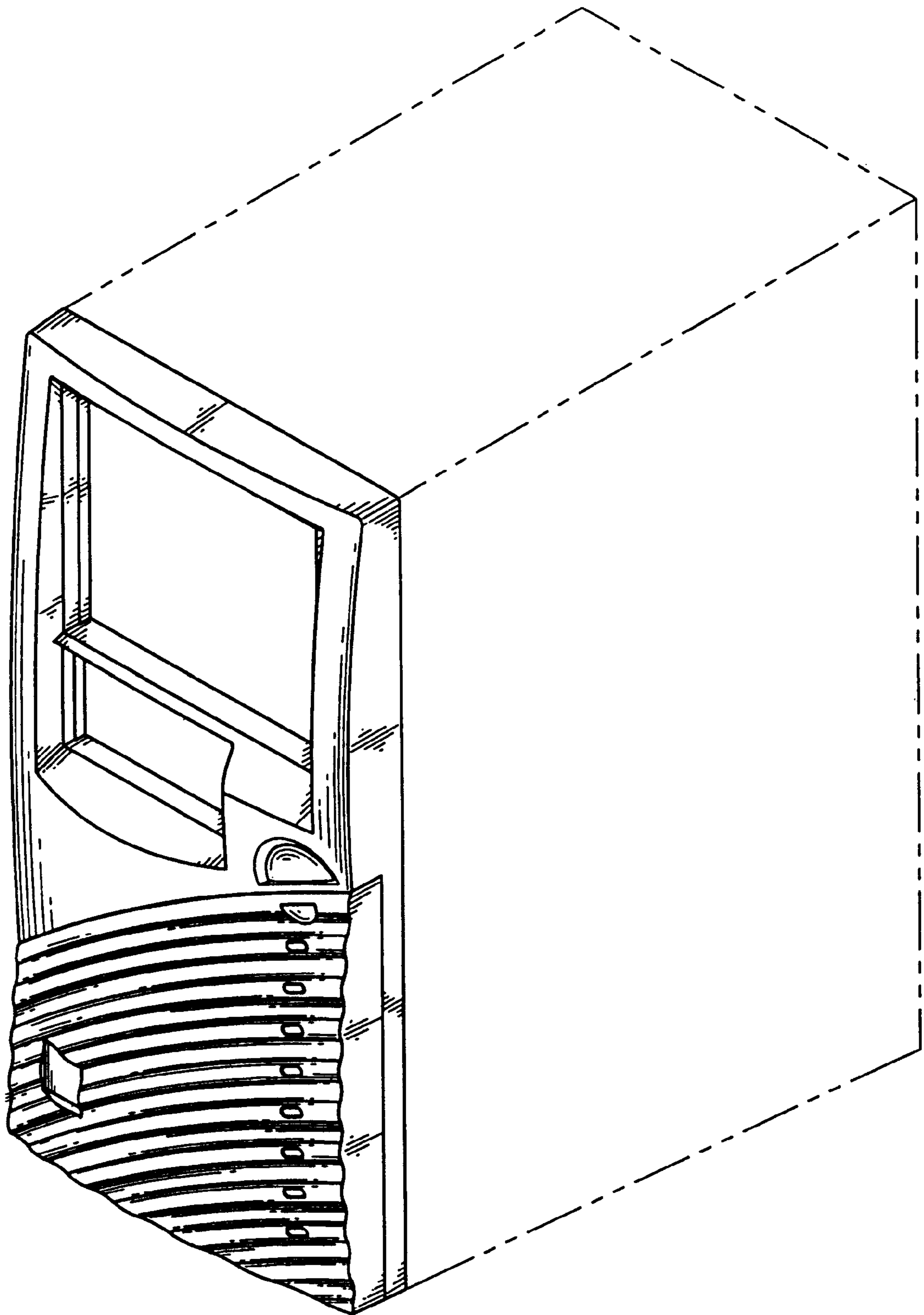

FIG. 16