

US00D432125S

United States Patent [19]

Masuda et al.

[11] Patent Number: Des. 432,125

[45] Date of Patent: ** *Oct. 17, 2000

[54] COMPUTER HOUSING IN A TOWER ORIENTATION

D. 394,644 5/1998 Acciaioli et al. D14/107
D. 396,030 7/1998 Murphy D14/100

[75] Inventors: **Kuni Masuda**, Cupertino; **Craig Leverault**, Mountain View; **Paul S. Montgomery**; **Herbert Pfeifer**, both of Cupertino; **Howard W. Stolz**, Soquel, all of Calif.

Primary Examiner—Freda Nunn
Attorney, Agent, or Firm—Conley, Rose & Tayon, PC; B. Noel Kivlin

[73] Assignee: **Sun Microsystems, Inc.**, Palo Alto, Calif.

[57] CLAIM

The ornamental design for a computer housing in a tower orientation, as shown and described.

[*] Notice: This patent is subject to a terminal disclaimer.

DESCRIPTION

[**] Term: **14 Years**

FIG. 1 is a top perspective view of a computer housing in a tower orientation;
FIG. 2 is a front view of a computer housing in a tower orientation;
FIG. 3 is a top view of a computer housing in a tower orientation;
FIG. 4 is a right side view of a computer housing in a tower orientation;
FIG. 5 is a back view of a computer housing in a tower orientation;
FIG. 6 is a bottom view of a computer housing in a tower orientation; and,
FIG. 7 is a left side view of a computer housing in a tower orientation.

[21] Appl. No.: **29/100,935**

[22] Filed: **Feb. 22, 1999**

[51] LOC (7) Cl. **14-02**

[52] U.S. Cl. **D14/349**

[58] Field of Search D14/300, 347, D14/348, 349; D6/432, 436, 445, 448; D13/162, 184, 199; 312/208.1; 360/99.12; 361/694, 696

The broken lines are shown in the views for illustrative purposes only and form no part of the claimed design.

[56] References Cited

U.S. PATENT DOCUMENTS

D. 389,811 1/1998 Wong et al. D14/100

1 Claim, 3 Drawing Sheets

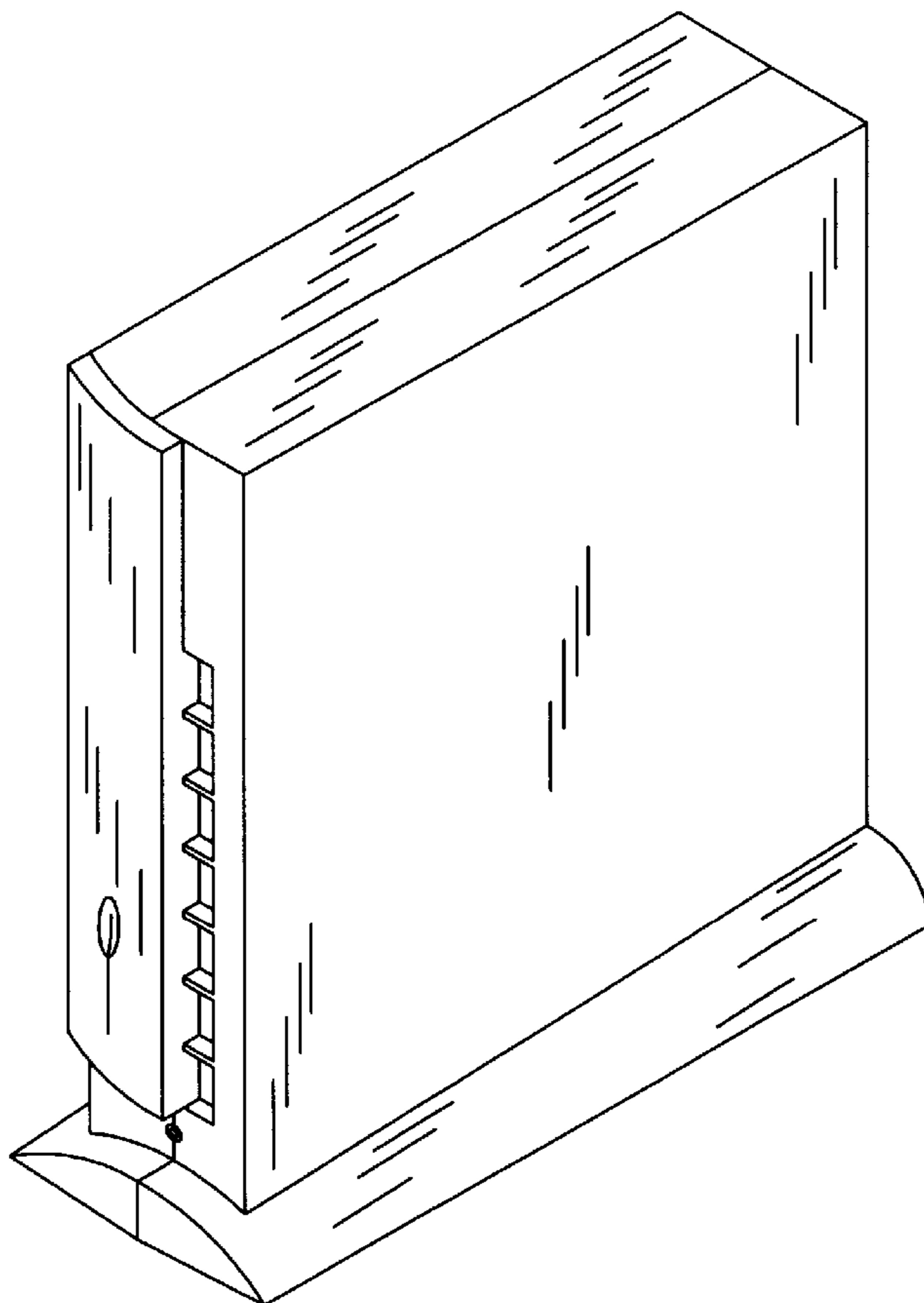

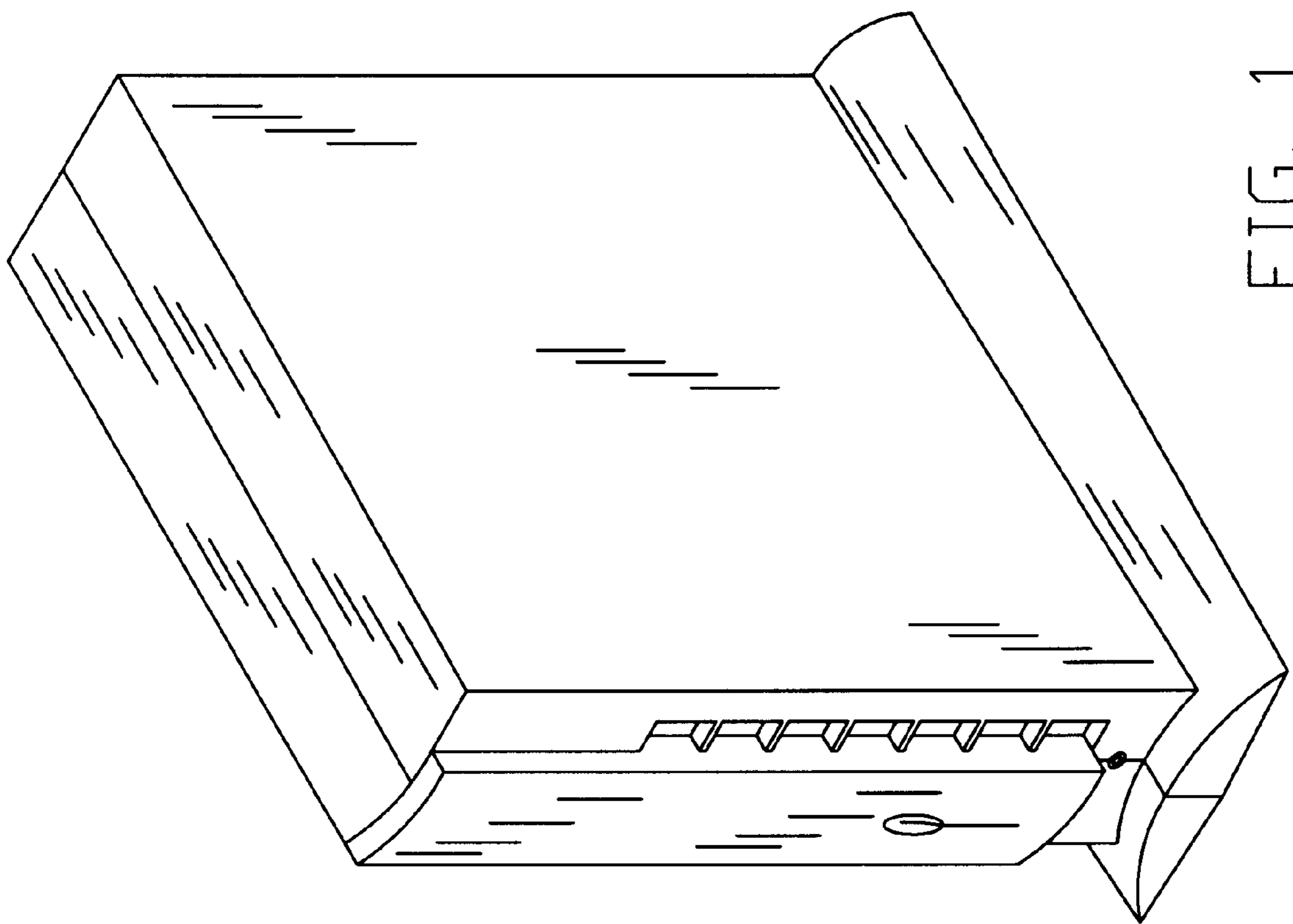

FIG. 1

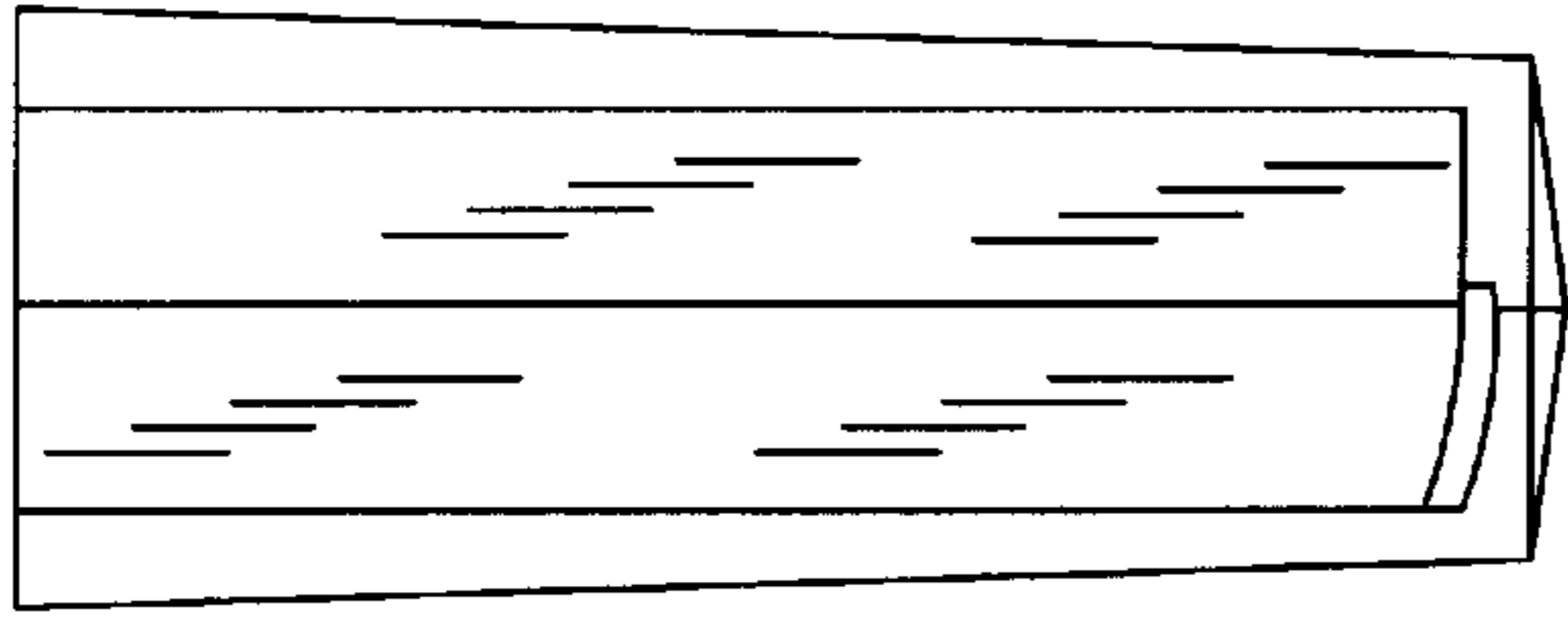

FIG. 3

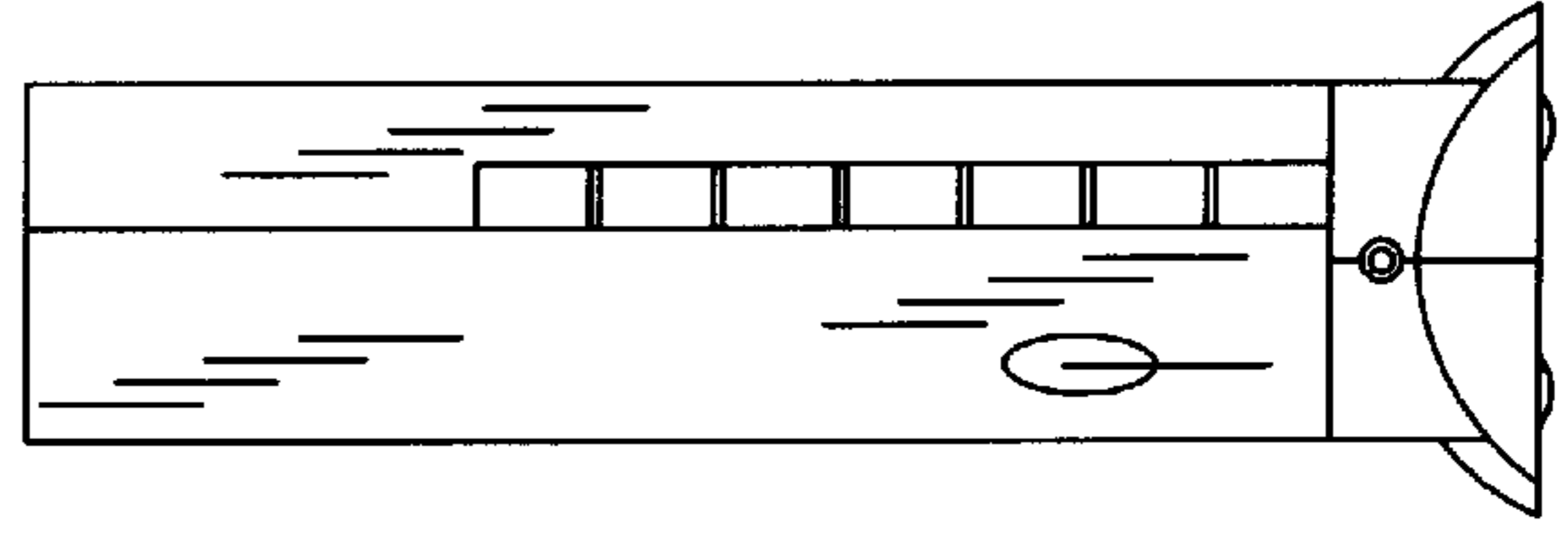

FIG. 2

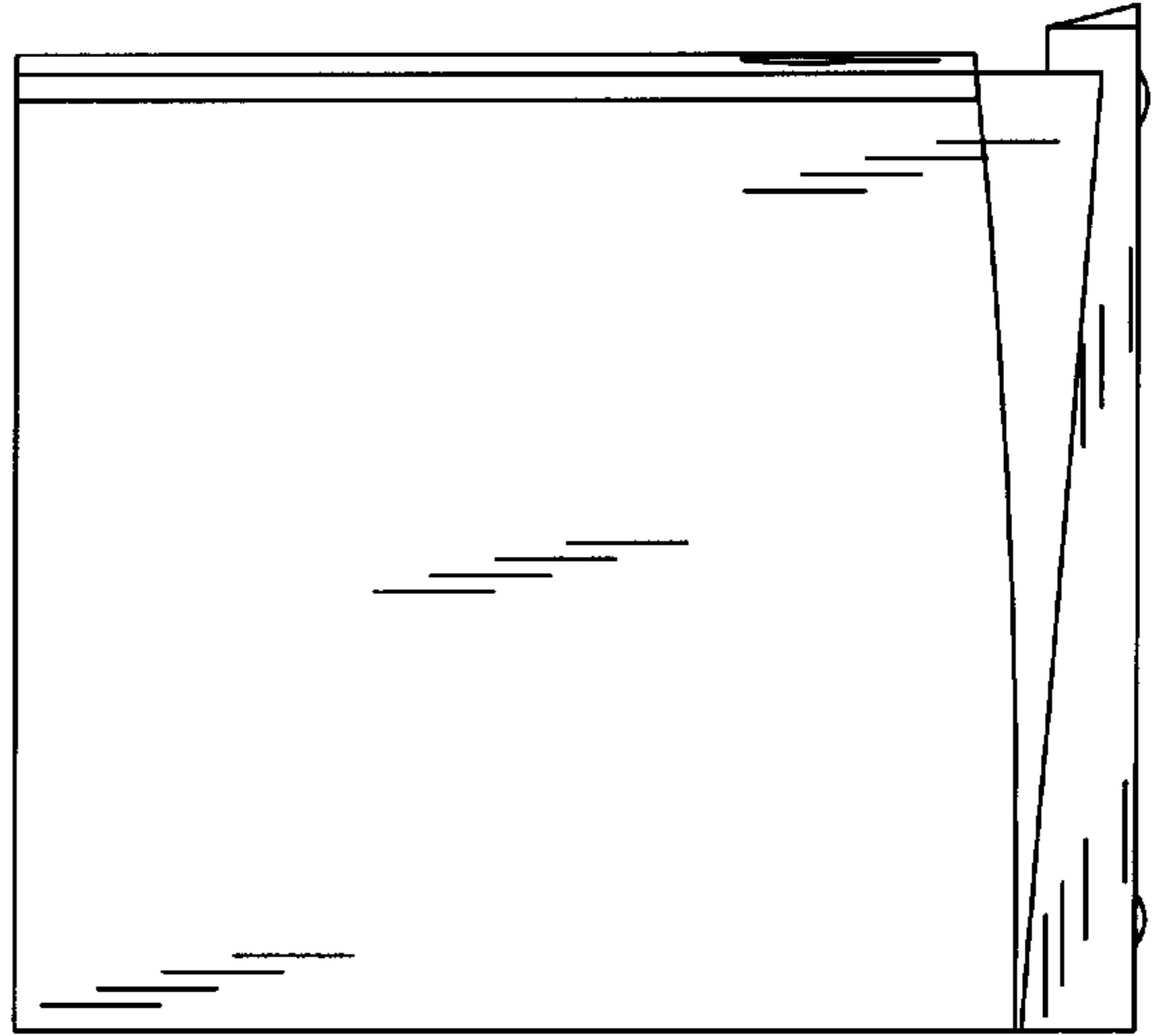

FIG. 4

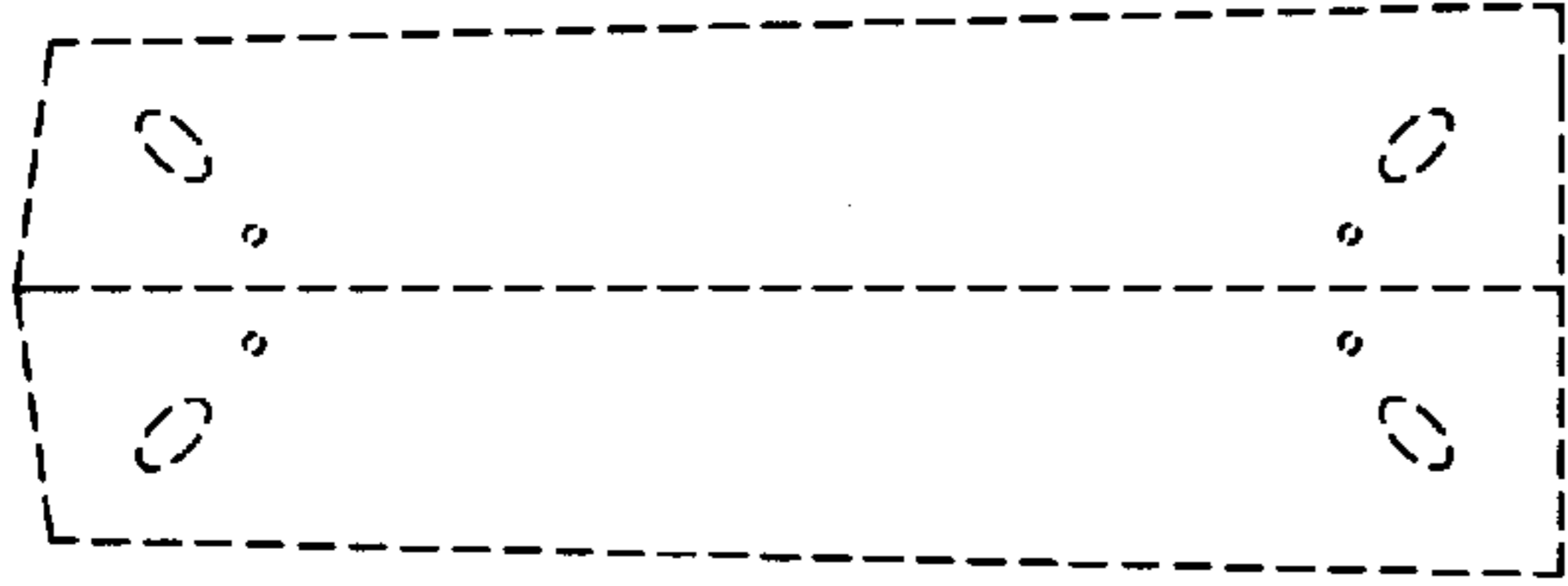

FIG. 6

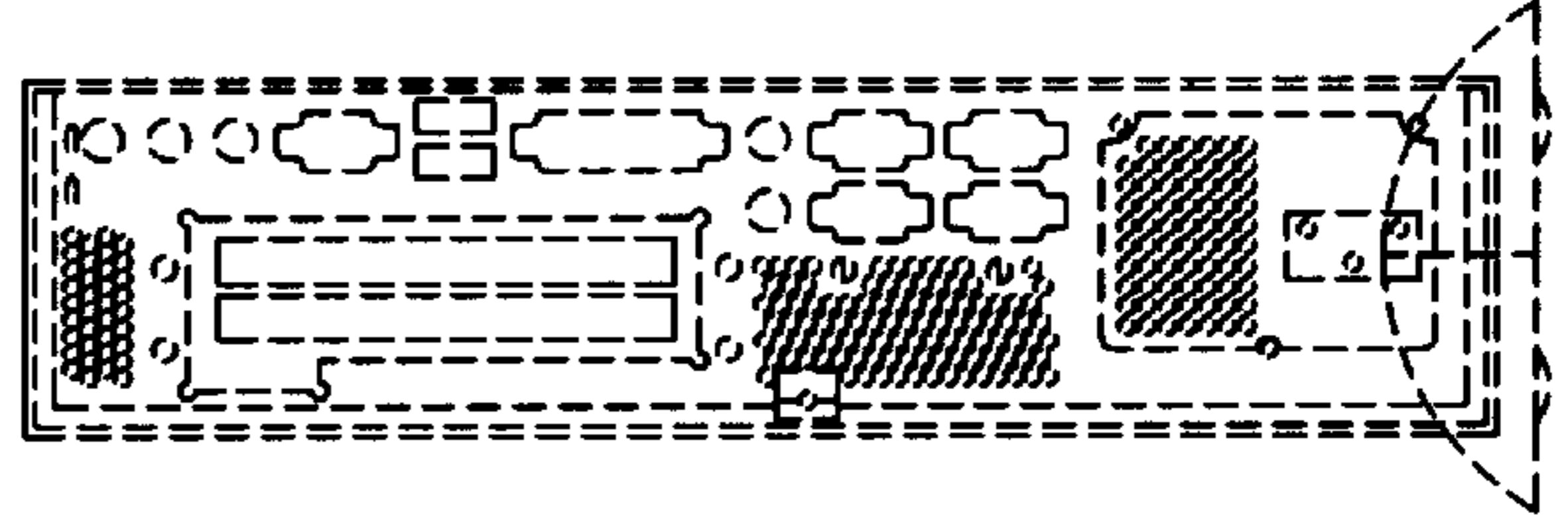

FIG. 5

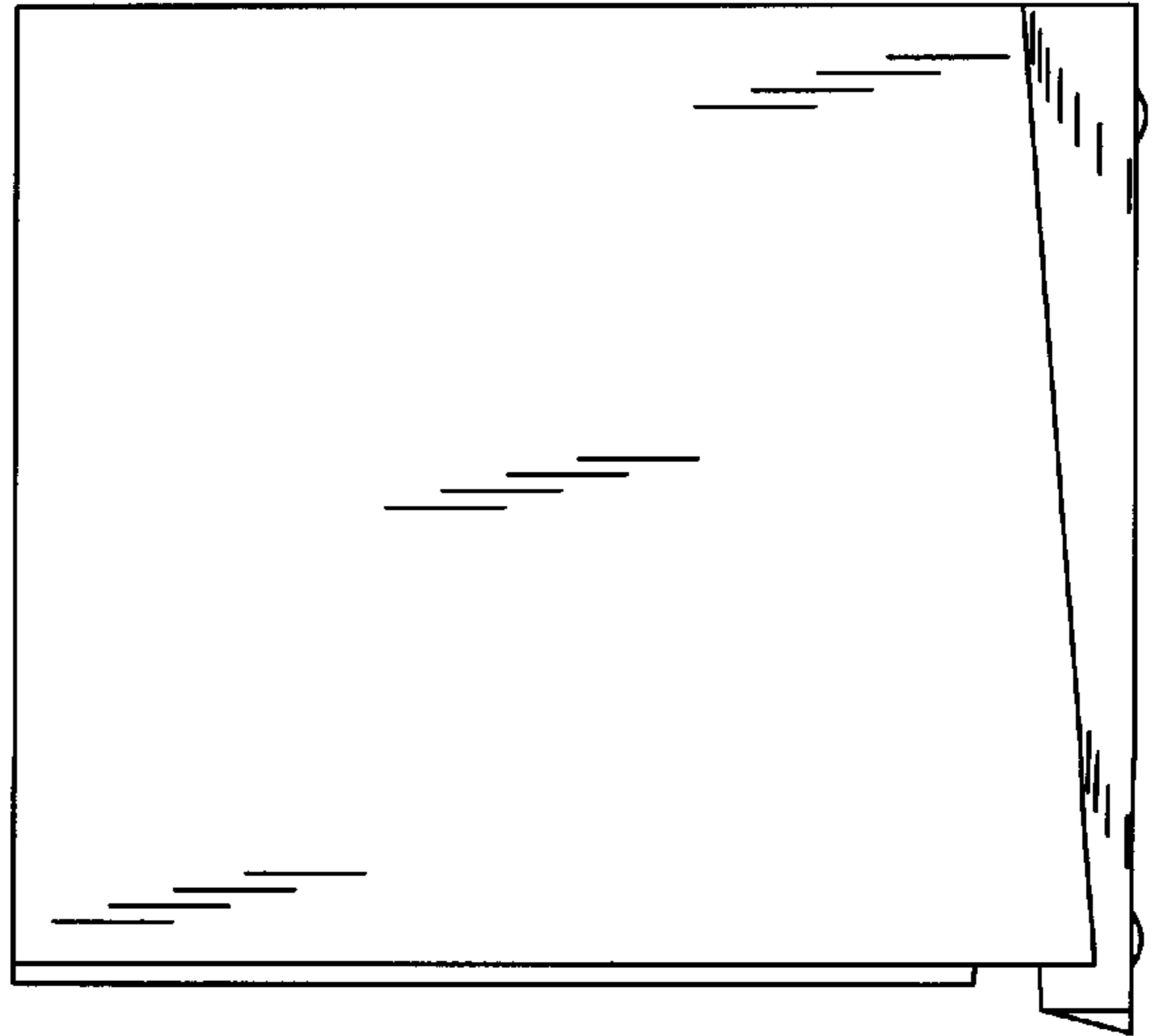

FIG. 7