



US00D432002S

# United States Patent [19]

Anderson et al.

[11] Patent Number: **Des. 432,002**

[45] Date of Patent: **\*\* Oct. 17, 2000**

[54] **HOSE REEL ENCLOSURE WITH RAISED PANELS**

[75] Inventors: **Torrence C. Anderson**, Aurora;  
**Michael G. Uffner**, Naperville, both of Ill.

[73] Assignee: **Suncast Corporation**, Batavia, Ill.

[\*\*] Term: **14 Years**

[21] Appl. No.: **29/117,121**

[22] Filed: **Jan. 18, 2000**

[51] **LOC (7) Cl.** ..... **08-05**

[52] **U.S. Cl.** ..... **D8/359**

[58] **Field of Search** ..... D8/359; D6/432,  
D6/501; 137/355.26, 355.27; 206/389; 242/397.5

[56] **References Cited**

**U.S. PATENT DOCUMENTS**

D. 285,901 9/1986 Gustavsson ..... D8/359  
5,011,034 4/1991 Abel ..... 206/389 X

*Primary Examiner*—Holly Baynham

*Attorney, Agent, or Firm*—Welsh & Katz, Ltd.

[57] **CLAIM**

The ornamental design for a hose reel enclosure with raised panels, as shown.

**DESCRIPTION**

FIG. 1 is a front perspective view of a hose reel enclosure with raised panels in accordance with the principles of the present invention, this figure showing the front and right-hand sides of the enclosure;

FIG. 2 is a front perspective view of the hose reel enclosure of FIG. 1, showing the front and left-hand side views of the enclosure;

FIG. 3 is a top view of the hose reel enclosure of FIG. 1;

FIG. 4 is a front view of the hose reel enclosure;

FIG. 5 is a side view of the hose reel enclosure as shown from the right-hand side of FIG. 1;

FIG. 6 is a side view of the hose reel enclosure as viewed from the left-hand side of FIG. 2;

FIG. 7 is a rear view of the hose reel enclosure; and,

FIG. 8 is a bottom view of the hose reel enclosure.

**1 Claim, 8 Drawing Sheets**

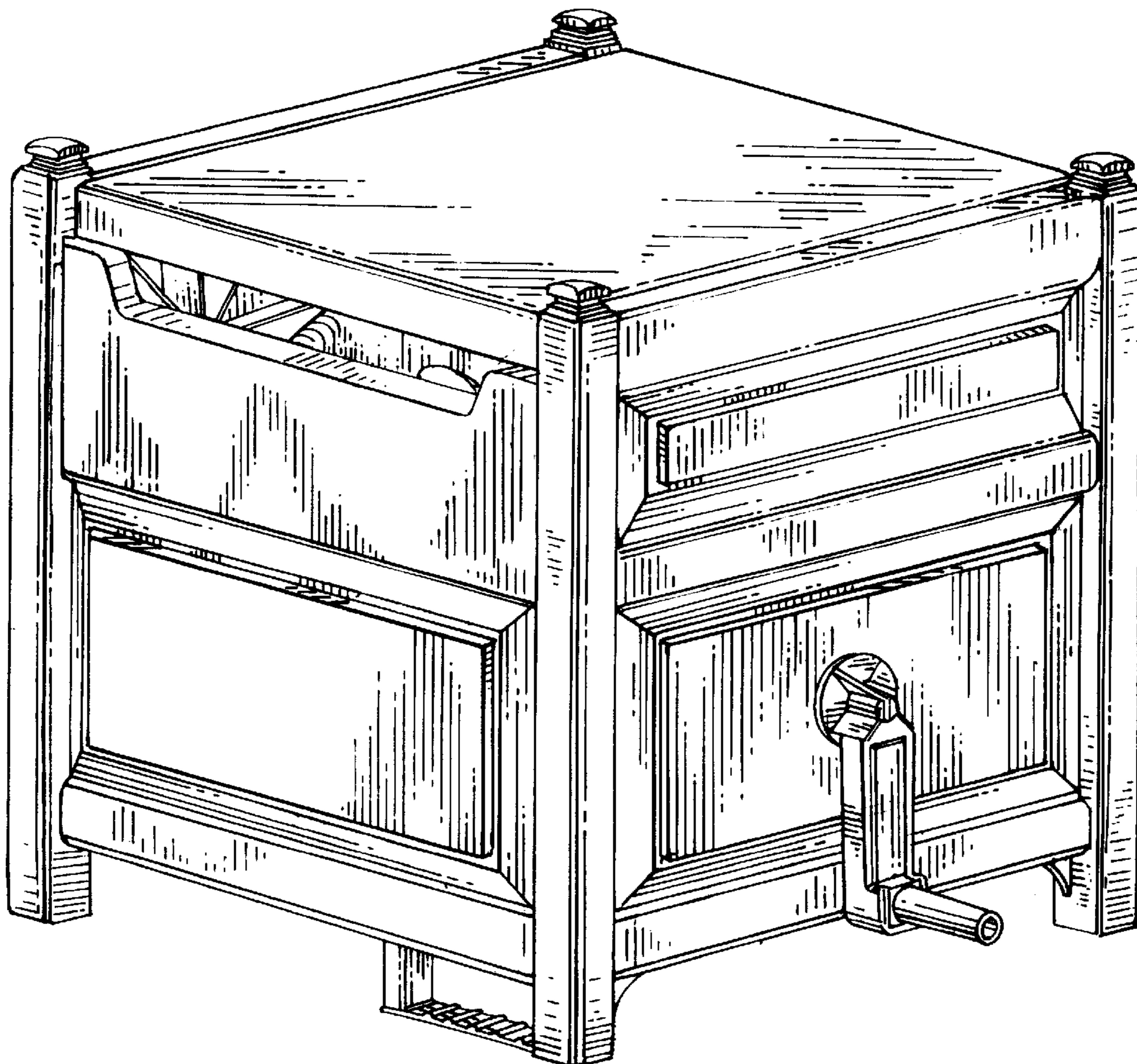

FIG. 1

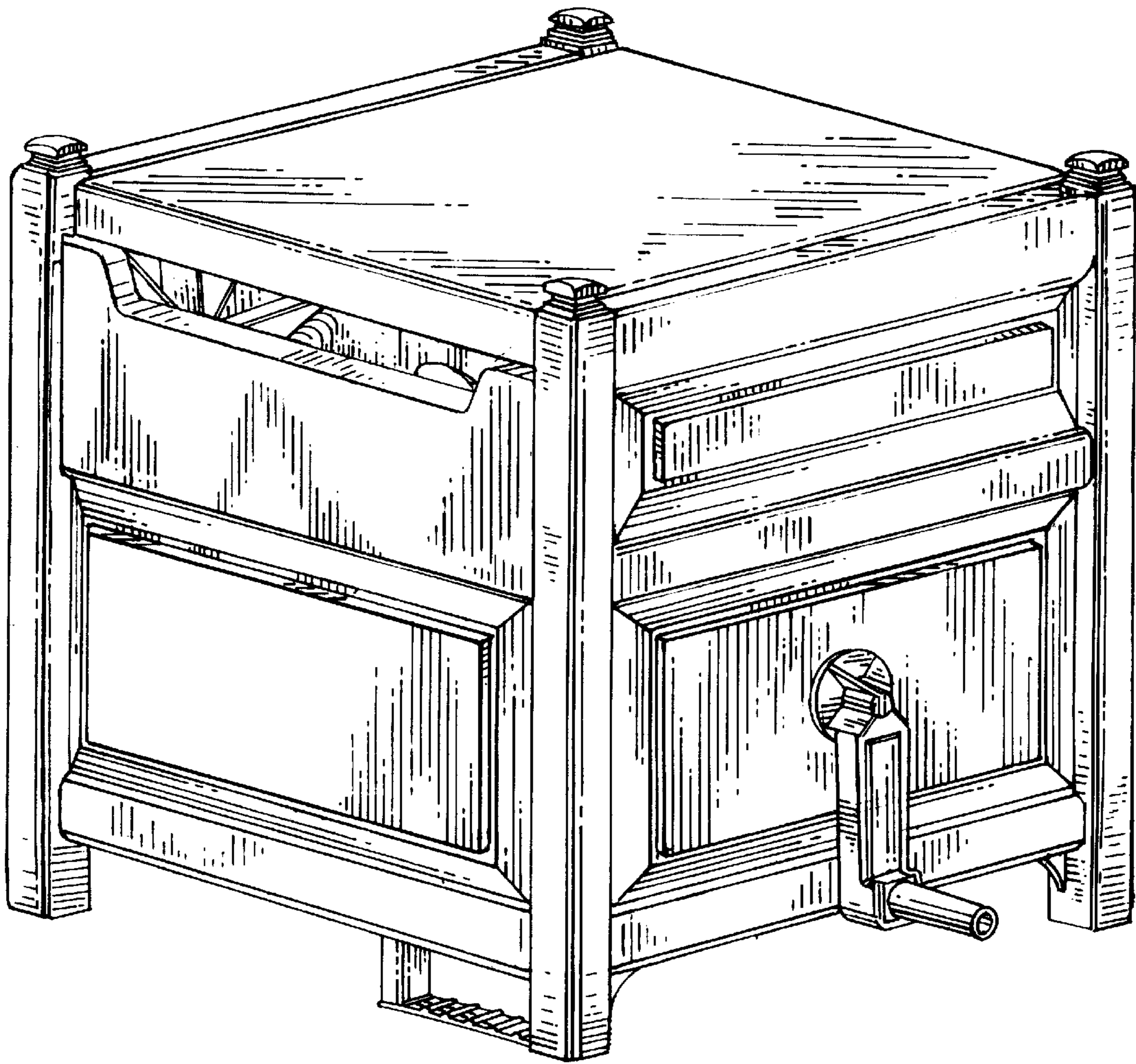

FIG. 2

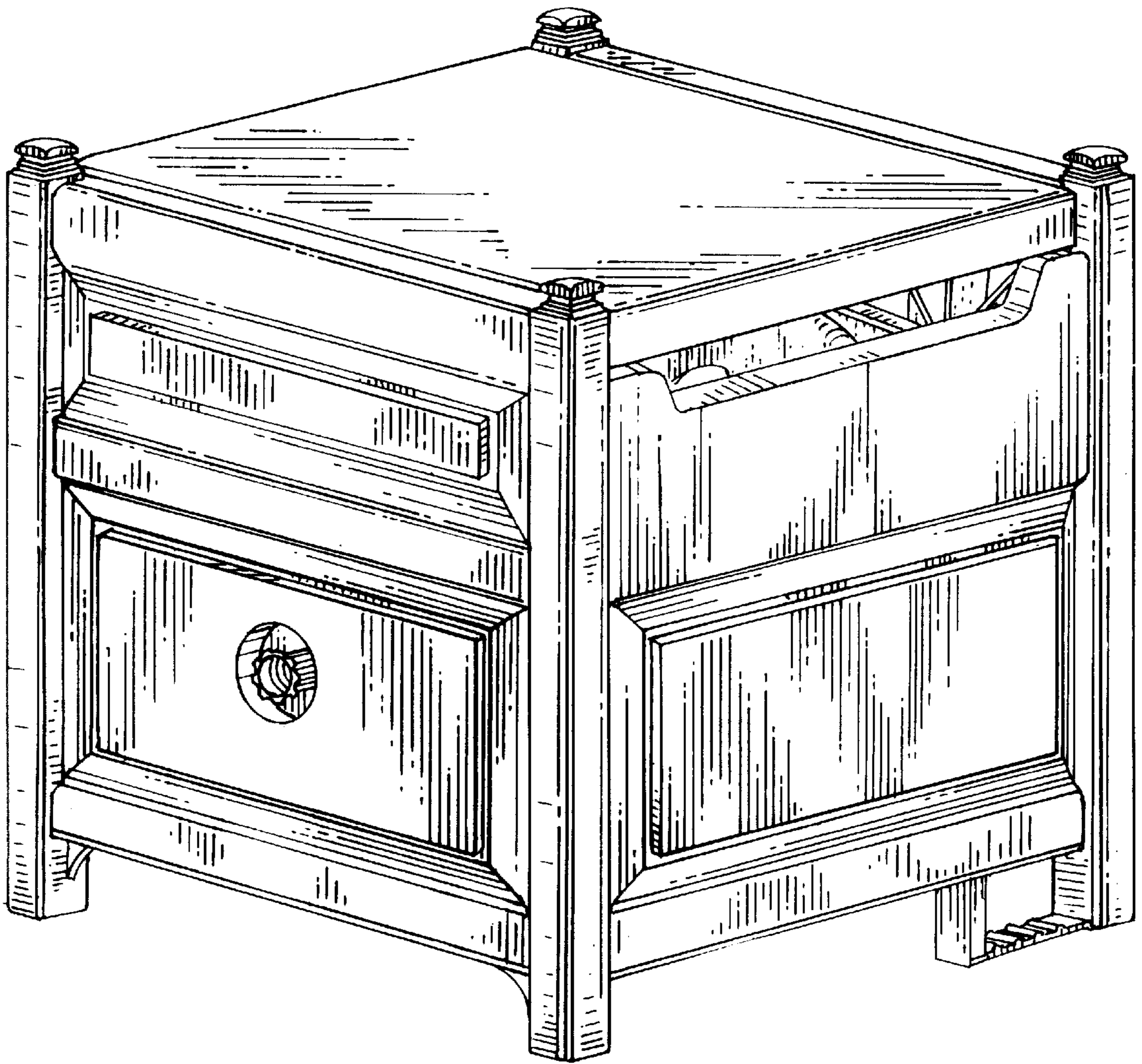

FIG. 3

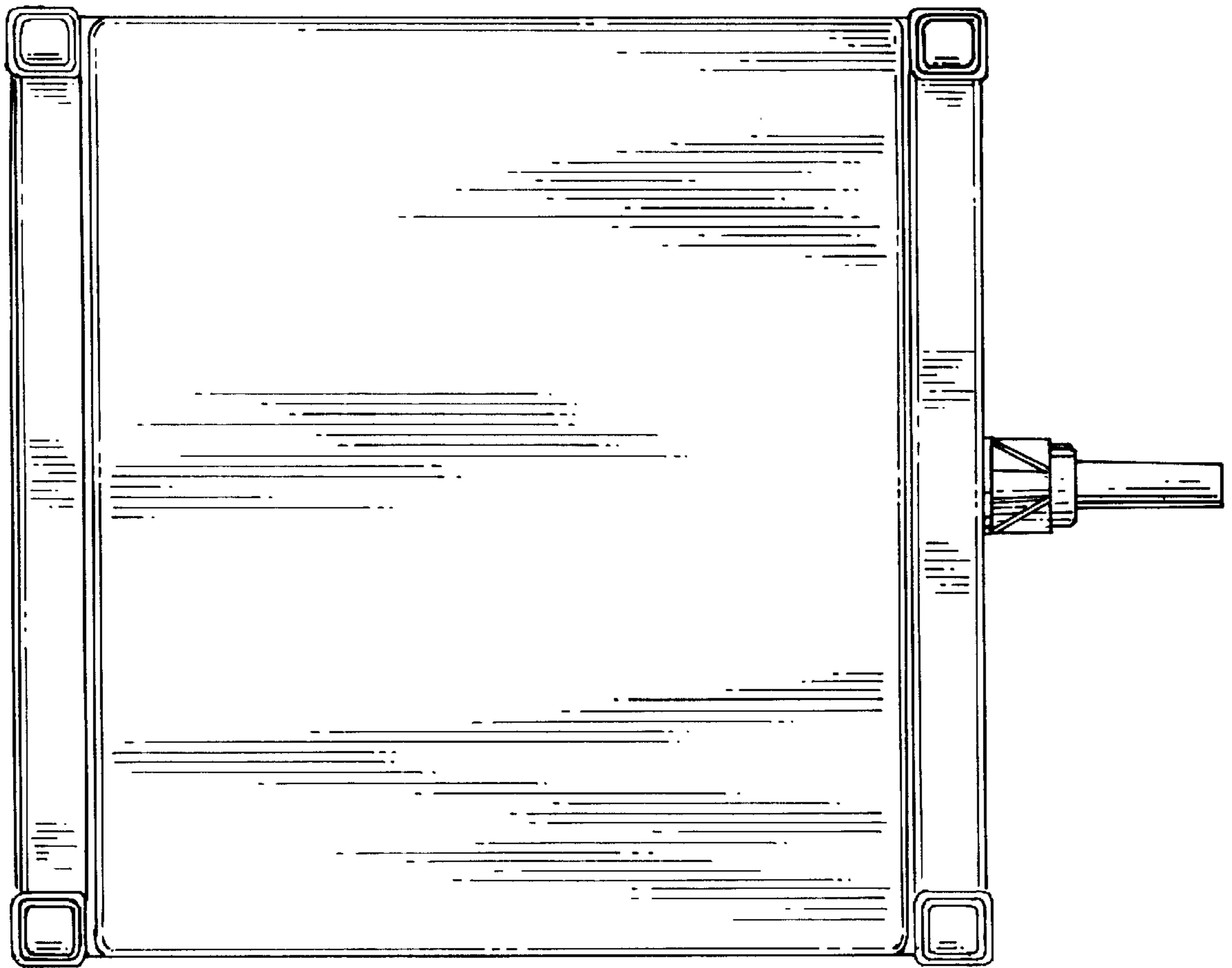

FIG. 4

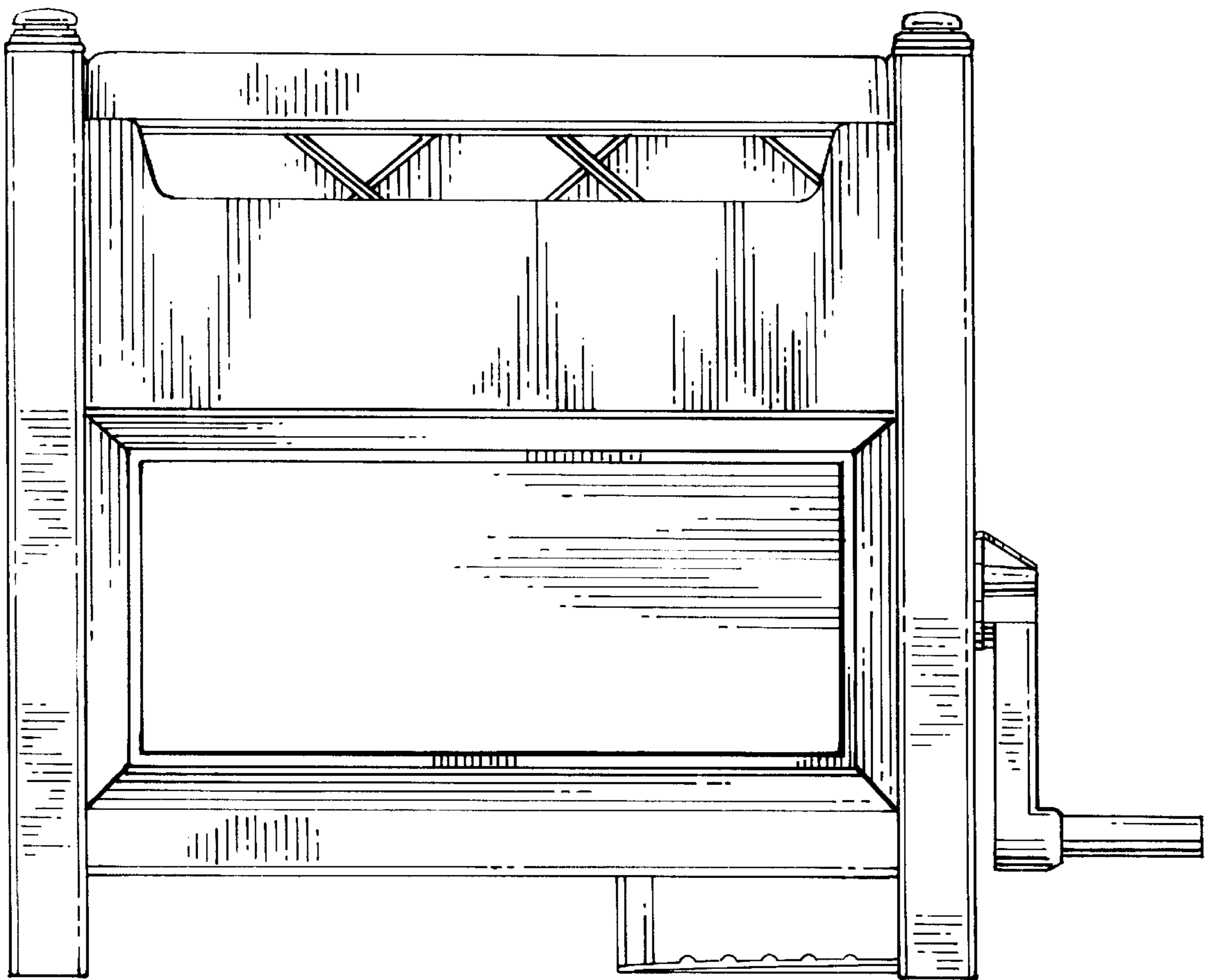

FIG. 5

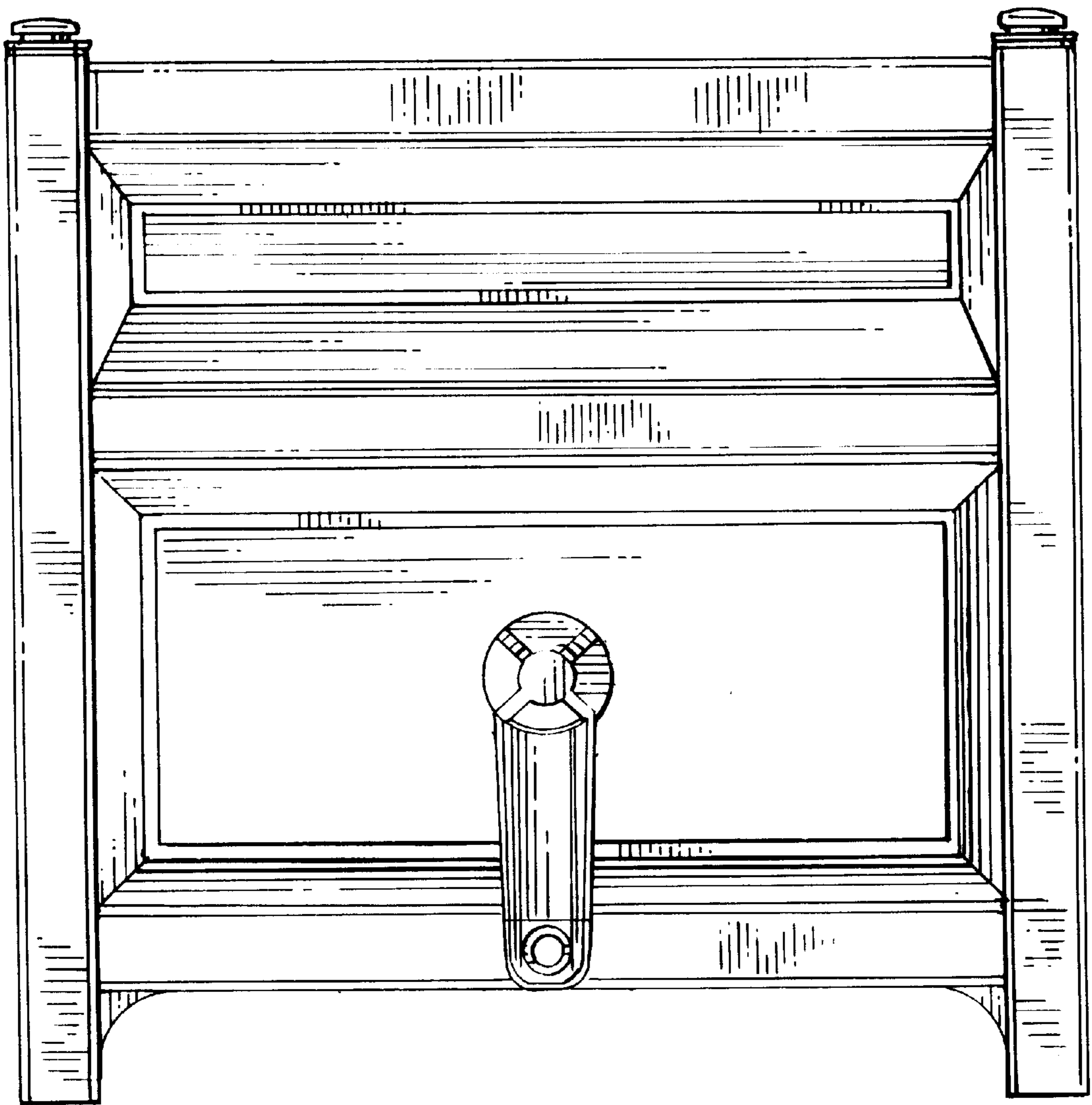

FIG. 6

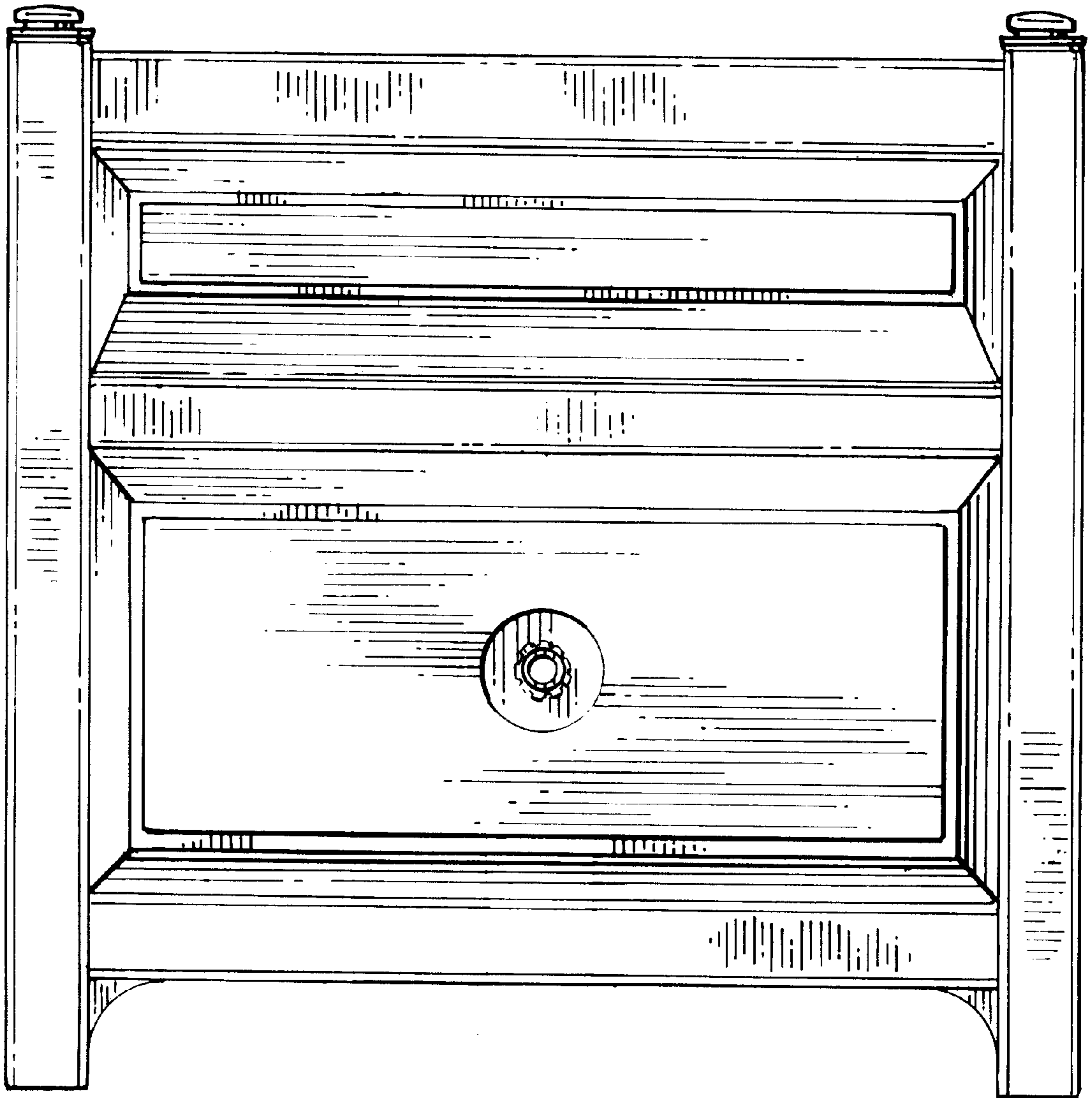

FIG. 7

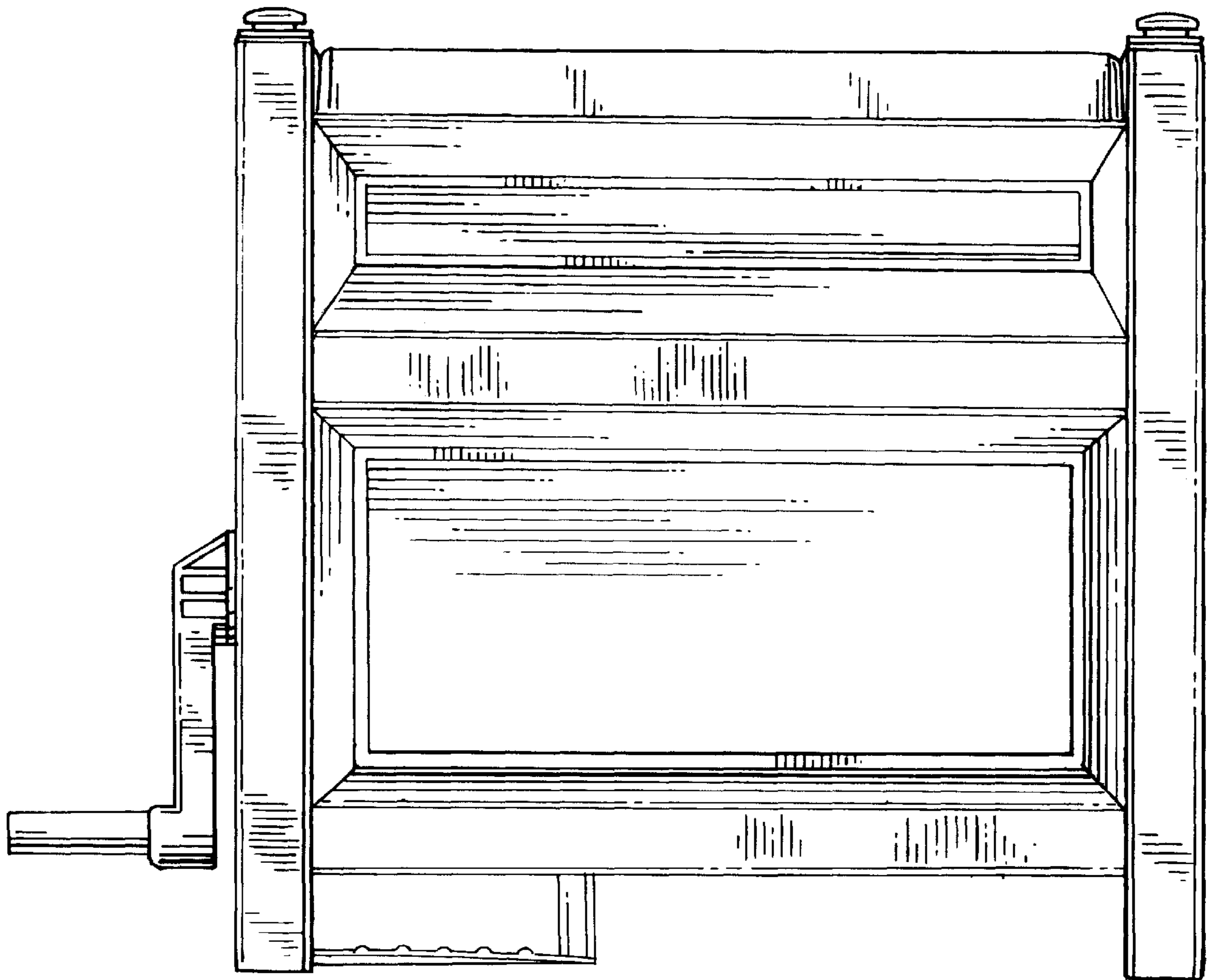



FIG. 8

