



US00D431988S

United States Patent [19] Staton

[11] **Patent Number: Des. 431,988**

[45] **Date of Patent: ** Oct. 17, 2000**

[54] **HAMMER**

[75] Inventor: **John Staton**, Bristol, Conn.

[73] Assignee: **The Stanley Works**, New Britain, Conn.

[**] Term: **14 Years**

[21] Appl. No.: **29/115,477**

[22] Filed: **Dec. 16, 1999**

[51] **LOC (7) Cl.** **08-02**

[52] **U.S. Cl.** **D8/75**

[58] **Field of Search** D8/75, 76, 77,
D8/78, 79, 80, 81; 81/20, 21, 22, 23, 24,
25; 7/143

[56] **References Cited**

U.S. PATENT DOCUMENTS

- D. 201,538 6/1965 Willis D8/75
- D. 322,021 12/1991 Hsu D8/75

- D. 325,863 5/1992 Chen D8/75
- D. 376,087 12/1996 Spierer D8/75
- D. 416,462 11/1999 Pringle et al. D8/75
- D. 420,881 2/2000 Davis et al. D8/75

Primary Examiner—Philip S. Hyder
Attorney, Agent, or Firm—Pillsbury Madison & Sutro LLP

[57] **CLAIM**

The ornamental design for a hammer, as shown and described.

DESCRIPTION

FIG. 1 is a perspective view, looking down at the rear and left side of a hammer embodying the new design; FIG. 2 is a left side elevational view thereof, the right side elevational view being a mirror image thereof; FIG. 3 is a front elevational view thereof; FIG. 4 is a rear elevational view thereof; FIG. 5 is a top plan view thereof; and, FIG. 6 is a bottom plan view thereof.

1 Claim, 4 Drawing Sheets

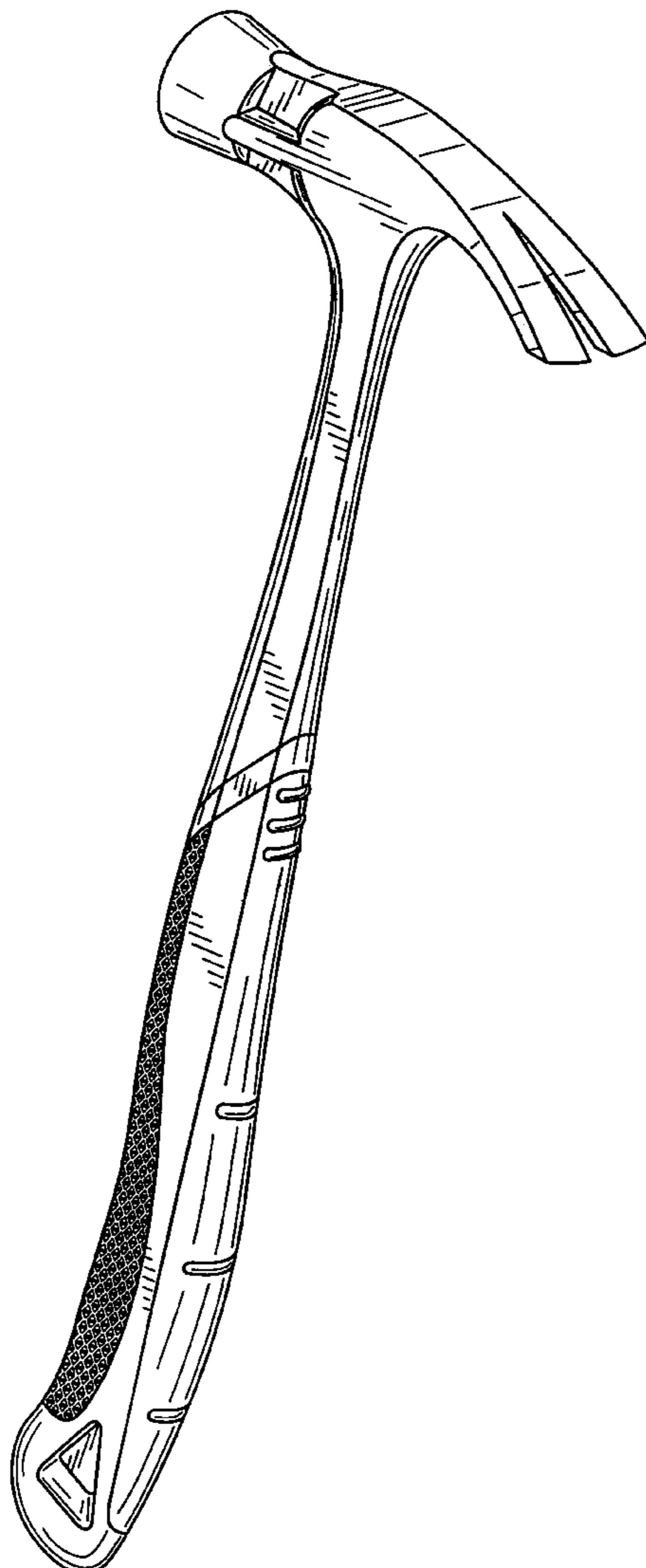

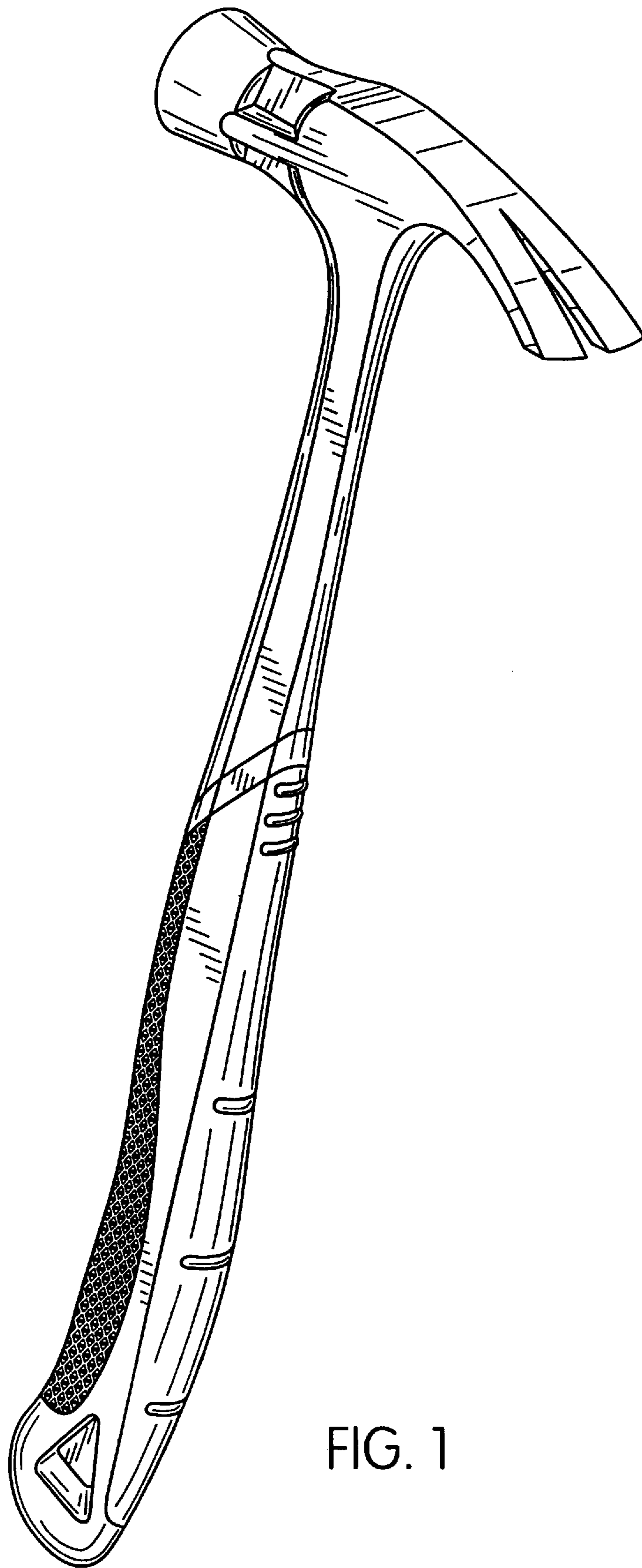

FIG. 1

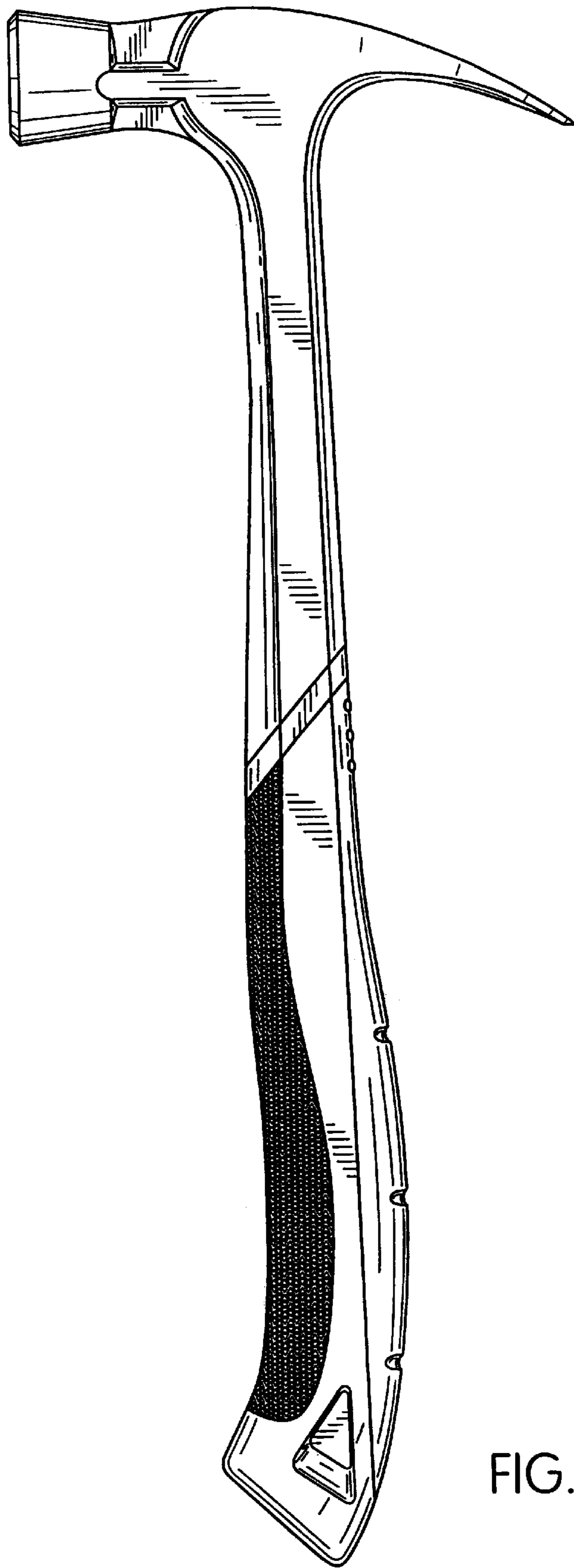

FIG. 2

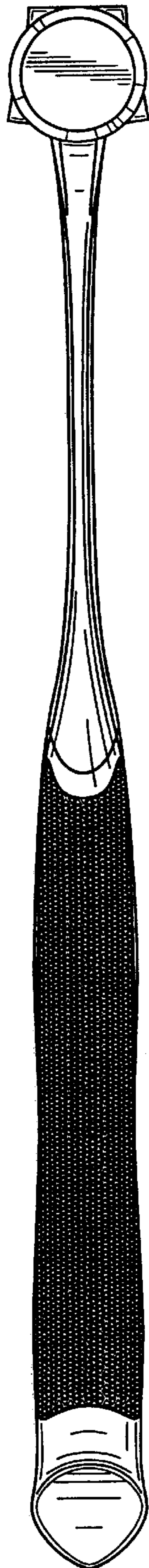

FIG. 3

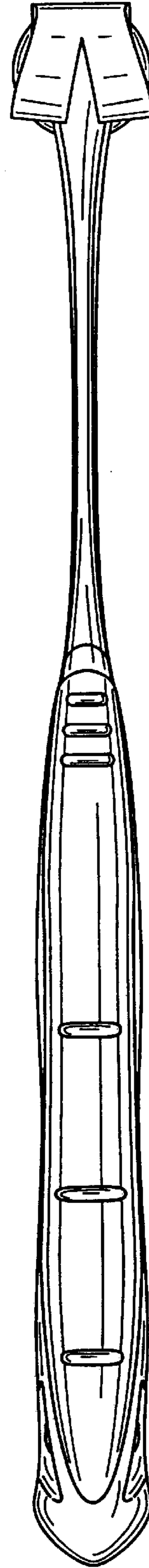

FIG. 4

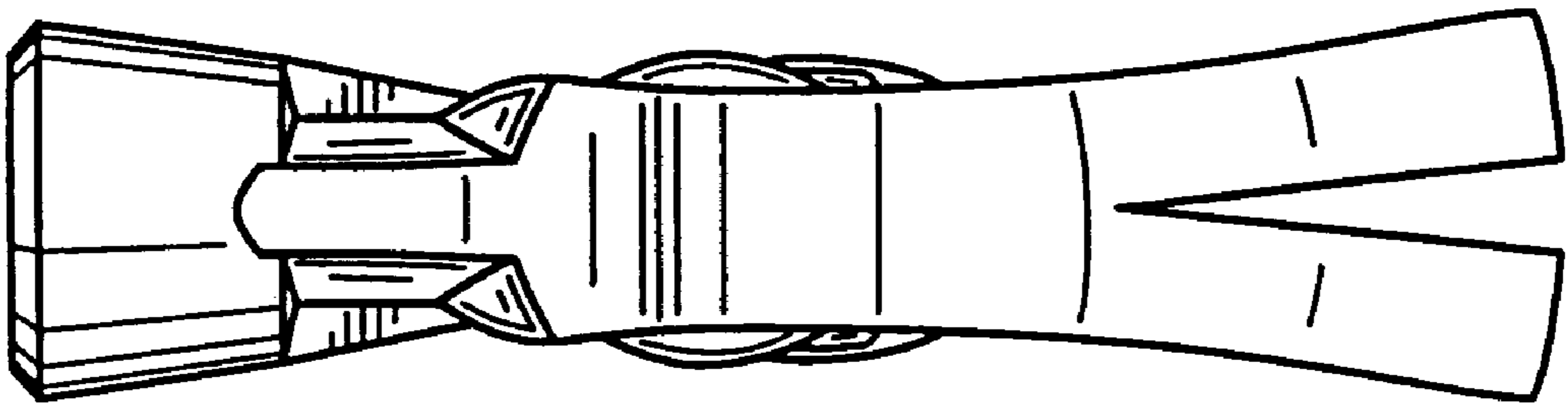

FIG. 5

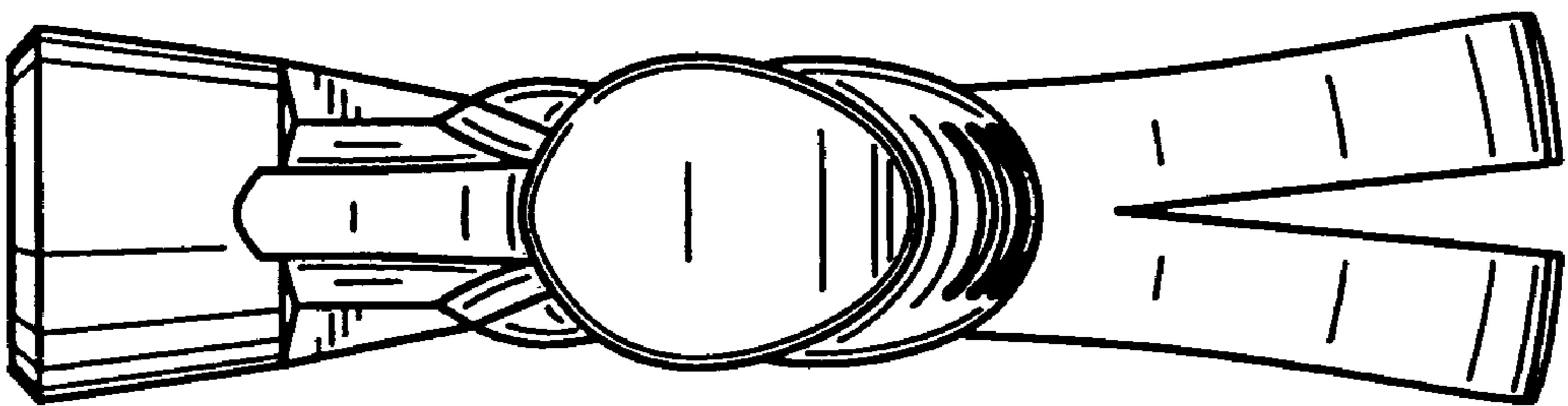

FIG. 6