



US00D431975S

United States Patent [19]

Backstrom et al.

[11] **Patent Number: Des. 431,975**

[45] **Date of Patent: ** Oct. 17, 2000**

[54] **UTENSIL HEAD**

[75] Inventors: **Mikael Backstrom**, Chicago; **Jeffrey Bull**, Naperville, both of Ill.

[73] Assignee: **Wilton Industries, Inc.**, Woodridge, Ill.

[**] Term: **14 Years**

[21] Appl. No.: **29/116,100**

[22] Filed: **Dec. 28, 1999**

[51] **LOC (7) Cl.** **07-04**

[52] **U.S. Cl.** **D7/688**

[58] **Field of Search** D7/401.2, 395,
D7/682-697, 642-664; 15/143.1, 236.01,
245, 245.1; 294/7; 416/71; 16/DIG. 18,
DIG. 19

[56] **References Cited**

U.S. PATENT DOCUMENTS

D. 304,144 10/1989 Gecchelin D7/688

Primary Examiner—Terry A. Wallace
Attorney, Agent, or Firm—Piper Marbury Rudnick & Wolfe

[57] **CLAIM**

The ornamental design for a utensil head, as shown and described.

DESCRIPTION

FIG. 1 is a perspective view of a utensil head showing our new design, the broken lines are for illustrative purposes only and form no part of the claimed design.

FIG. 2 is a right side elevational view thereof;

FIG. 3 is a bottom plan view thereof;

FIG. 4 is a front elevational view thereof;

FIG. 5 is a left side elevational view thereof; and,

FIG. 6 is a top plan view thereof.

1 Claim, 1 Drawing Sheet

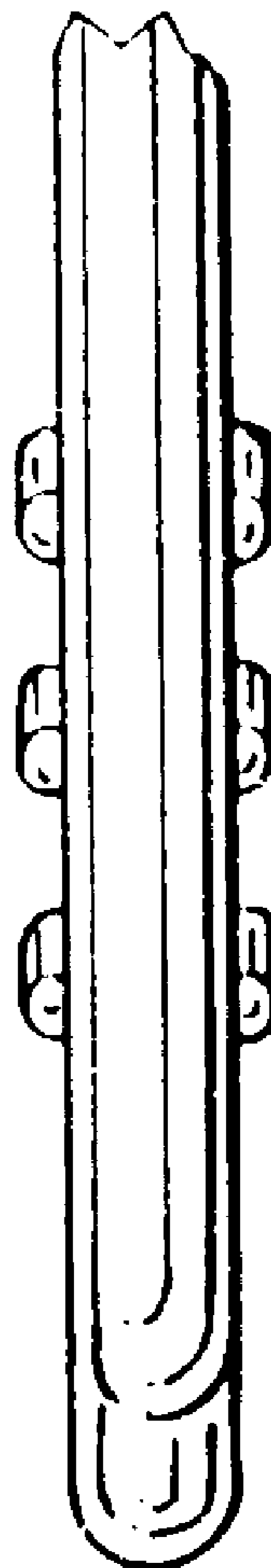
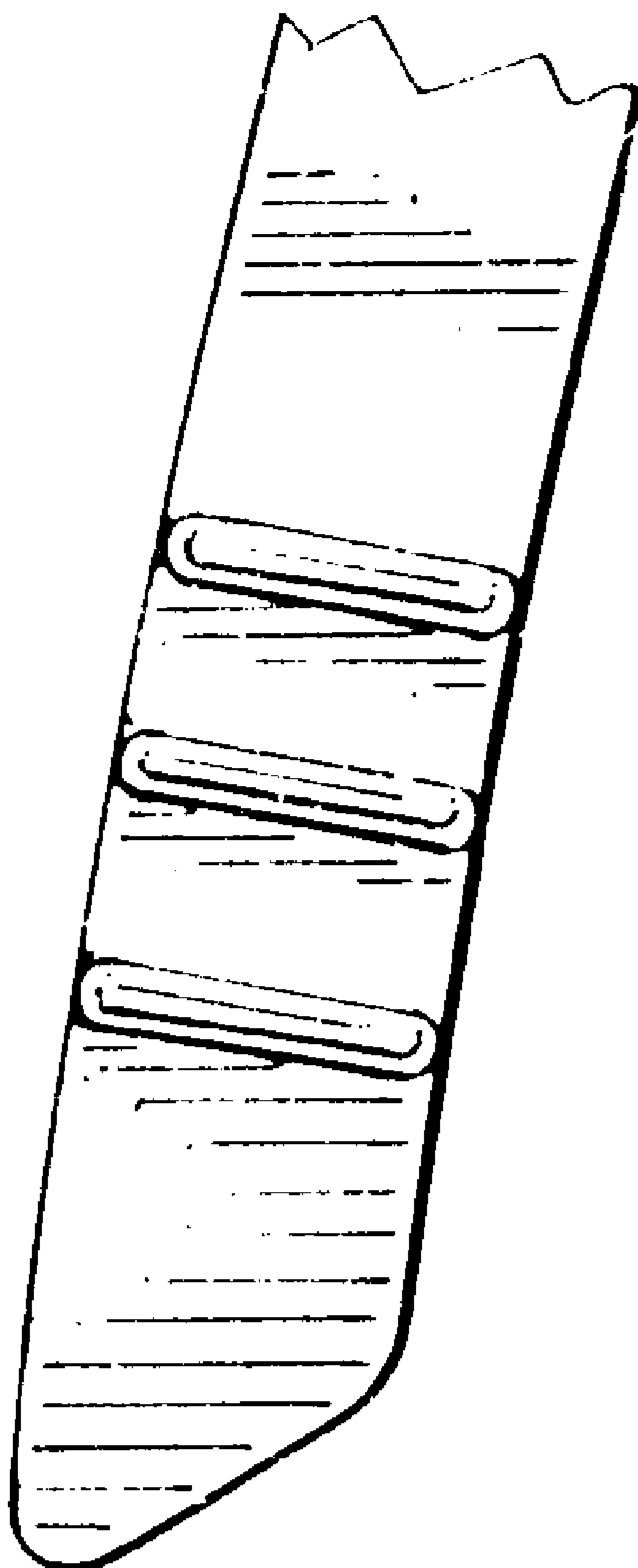

FIG. 1

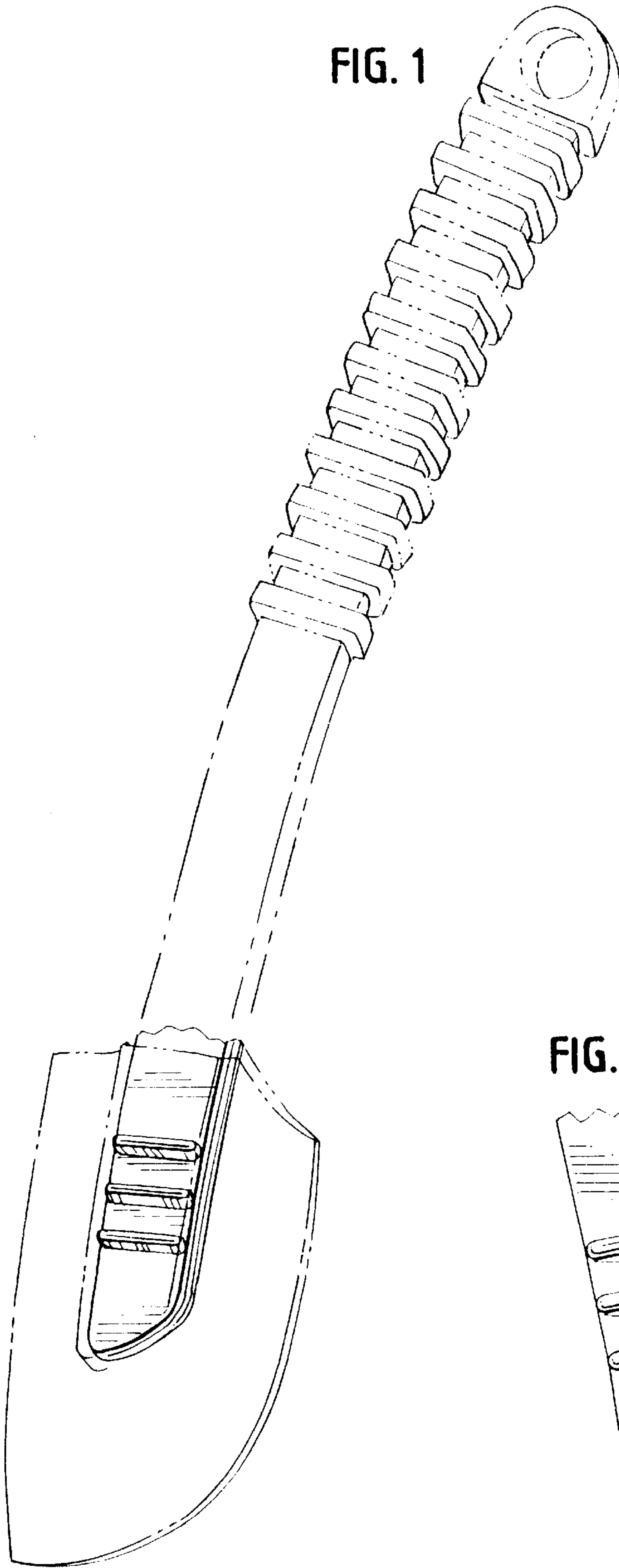

FIG. 2

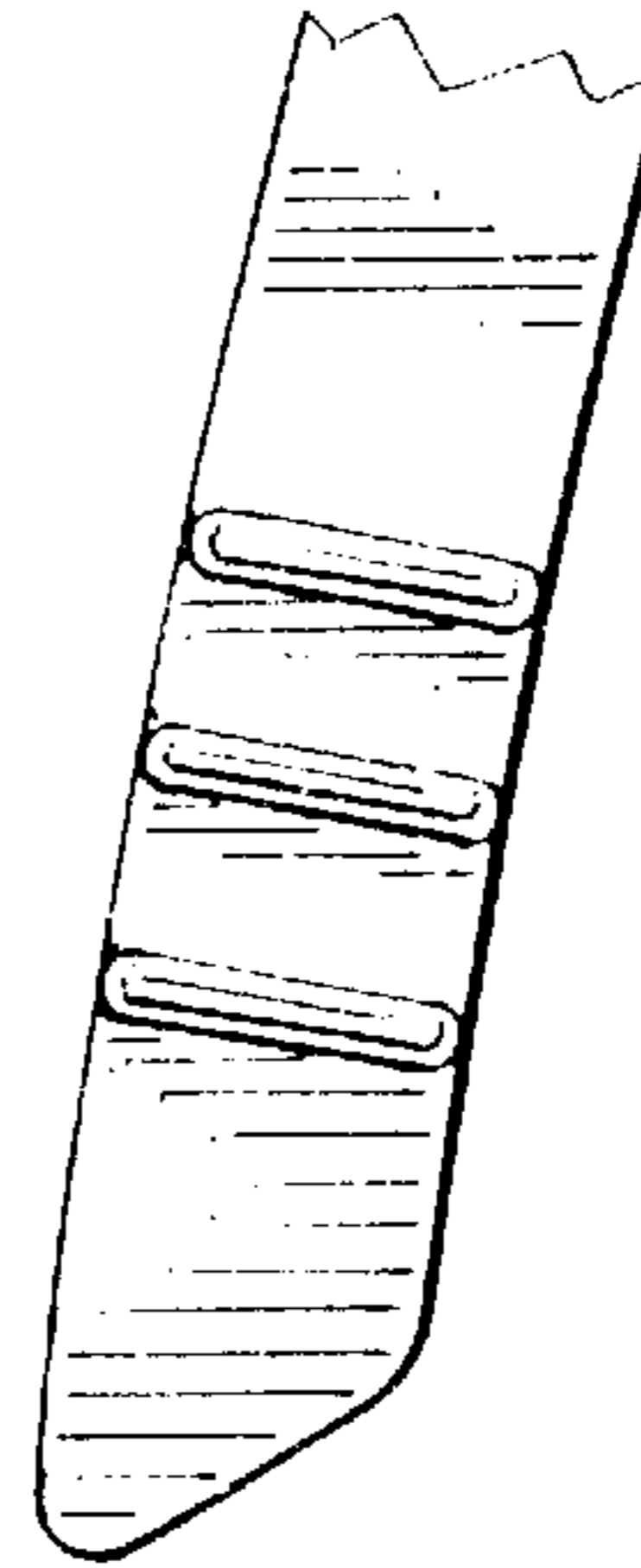

FIG. 3

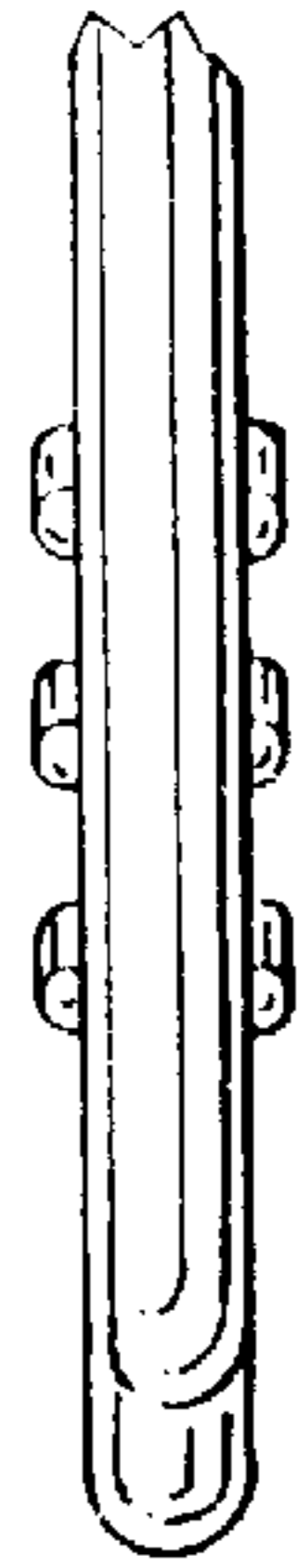

FIG. 4

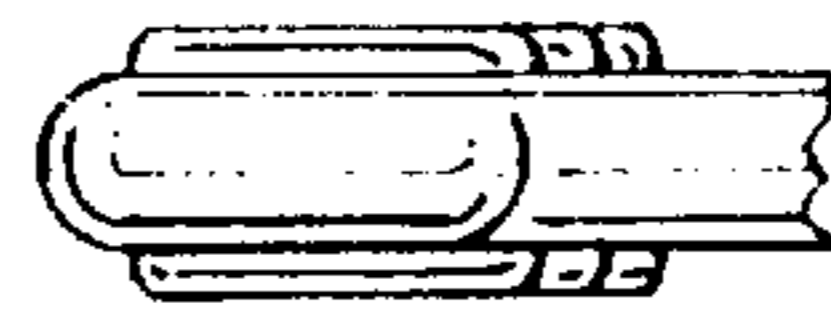

FIG. 5

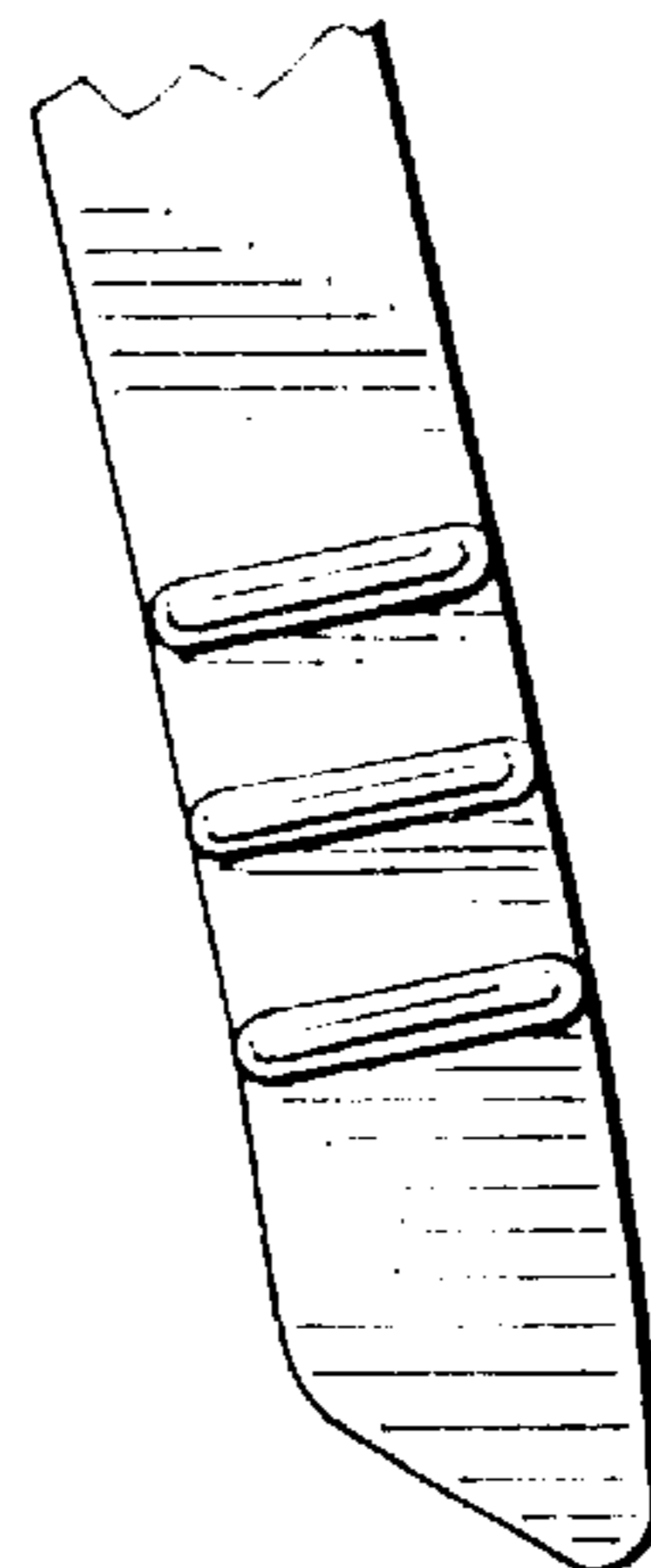

FIG. 6

