



US00D431888S

# United States Patent [19] Roudebush

[11] Patent Number: Des. 431,888

[45] Date of Patent: \*\* \*Oct. 10, 2000

[54] **COMBINED DIAPER PAIL FRAME AND LID**

[75] Inventor: **H. Richard Roudebush**, Indianapolis, Ind.

[73] Assignee: **Cosco Management, Inc.**, Wilmington, Del.

[\*] Notice: This patent is subject to a terminal disclaimer.

[\*\*] Term: **14 Years**

[21] Appl. No.: **29/098,994**

[22] Filed: **Jan. 11, 1999**

[51] **LOC (7) Cl.** ..... **09-09**

[52] **U.S. Cl.** ..... **D32/53; D34/11**

[58] **Field of Search** ..... D34/9, 10, 11, D34/7; 220/263, 334, 908, 909, 910, 911; D32/37, 36

[56] **References Cited**

**U.S. PATENT DOCUMENTS**

- D. 288,019 1/1987 Gebhard et al. .
- D. 322,350 12/1991 Craft, Jr. et al. .

(List continued on next page.)

**OTHER PUBLICATIONS**

Diaper Genie, 1997 Mondial Industries, Limited Streetsboro, Ohio (1 page).

(List continued on next page.)

*Primary Examiner*—Cynthia E Ramirez  
*Attorney, Agent, or Firm*—Barnes & Thornburg

[57] **CLAIM**

The ornamental design for a combined diaper pail frame and lid, as shown and described.

**DESCRIPTION**

FIG. 1 is a perspective view of a combined diaper pail frame and lid according to my new design, with the diaper pail,

which forms the environment of the diaper pail frame and lid being partly illustrated in broken lines, which broken lines are for illustrative purposes only and form no part of the claimed design;

FIG. 2 is a front elevational view thereof;

FIG. 3 is a right-side elevational view thereof, with the left-side elevational view being the same;

FIG. 4 is a top plan view thereof;

FIG. 5 is a rear elevational view thereof;

FIG. 6 is a perspective view of the combined diaper pail frame and lid according to my new design, with the diaper pail, which forms the environment of the combined diaper pail frame and lid, being partly illustrated in broken lines, which broken lines are for illustrative purposes only and form no part of the claimed design, the lid being shown in a closed position relative to the diaper pail lid frame;

FIG. 7 is a front elevational view of the combined diaper pail frame and lid of FIG. 6;

FIG. 8 is a right-side elevational view of the combined diaper pail frame and lid of FIG. 6, with the left-side elevational view being the same;

FIG. 9 is a top plan view of the combined diaper pail frame and lid of FIG. 6;

FIG. 10 is a rear elevational view of the combined diaper pail frame and lid of FIG. 6;

FIG. 11 is a perspective view of the combined diaper pail frame and lid when the lid is in an opened position relative to the diaper pail lid frame, with the diaper pail, which forms the environment of the diaper pail lid frame, being partly illustrated in broken lines, which broken lines are for illustrative purposes only and form no part of the claimed design;

FIG. 12 is a top plan view of the combined diaper pail frame and lid of FIG. 11;

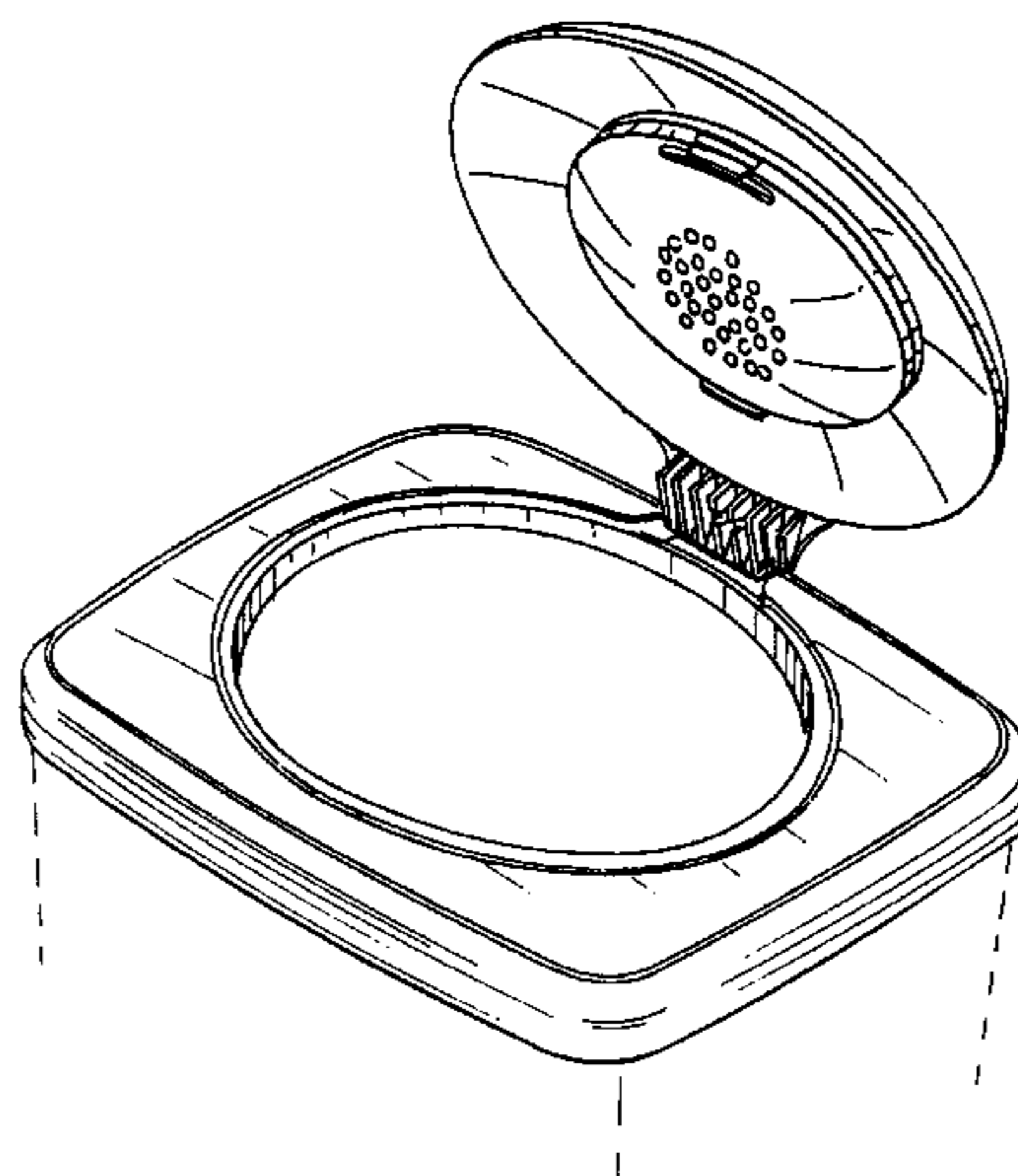
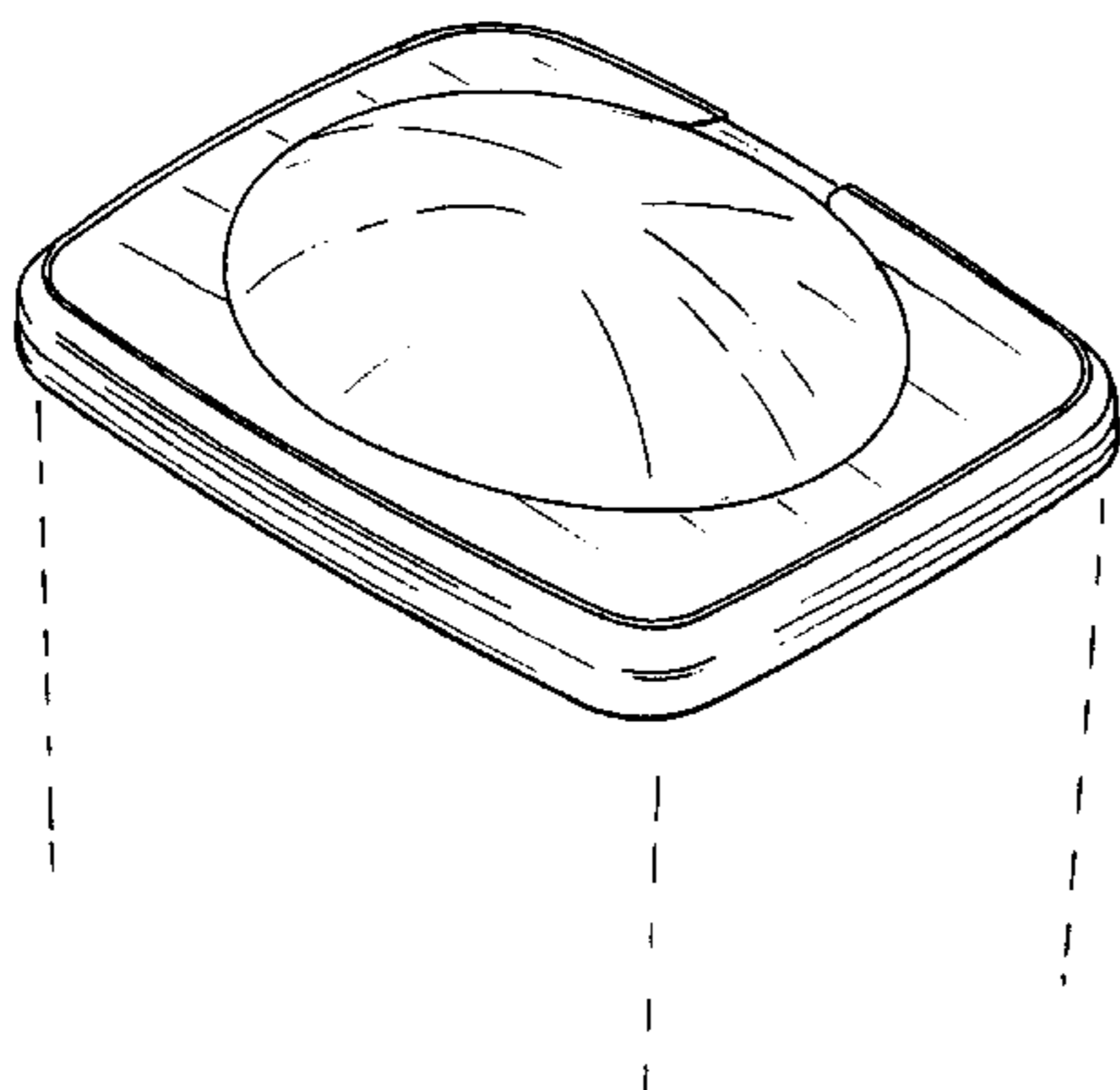
FIG. 13 is a front view of the combined diaper pail frame and lid of FIG. 11;

FIG. 14 is a right-side elevational view of the combined diaper pail frame and lid of FIG. 11, with the left-side elevational view being the same; and,

FIG. 15 is a rear elevational view of the combined diaper pail frame and lid assembly of FIG. 11.

The lid is not shown in FIGS. 1 through 5 for convenience of illustration.

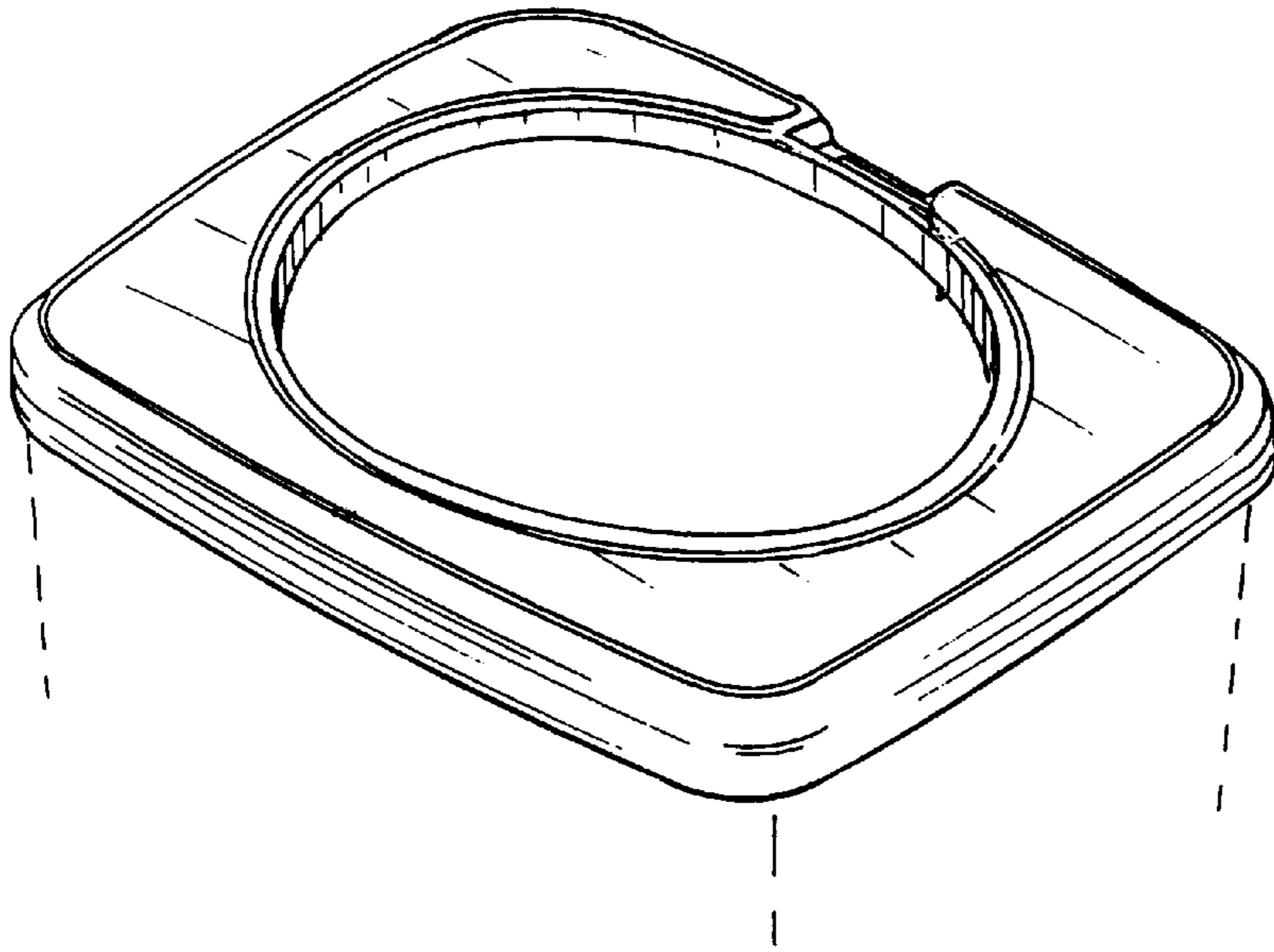
**1 Claim, 7 Drawing Sheets**



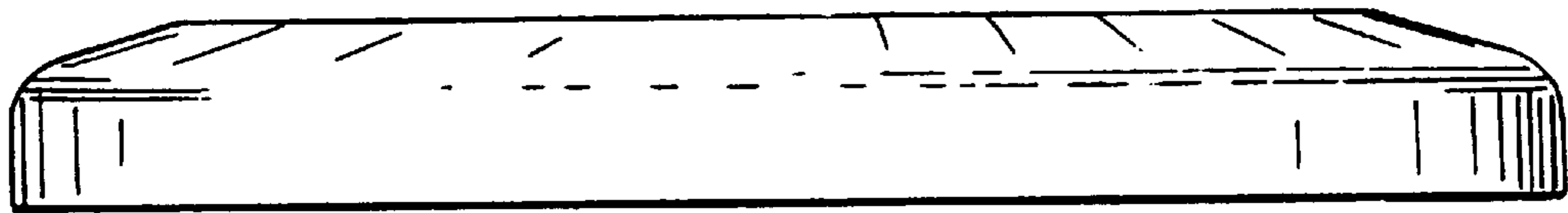
U.S. PATENT DOCUMENTS

D. 329,312	9/1992	Ross .	5,242,074	9/1993	Conaway et al. .
D. 329,929	9/1992	Knoedler et al. .	5,385,259	1/1995	Bernstein et al. .
D. 355,060	1/1995	Bernstein et al. .	5,520,303	5/1996	Bernstein et al. .
D. 362,933	10/1995	Calmeise .	5,535,913	7/1996	Asbach et al. .
D. 368,563	4/1996	Brightmill et al. .	5,657,894	8/1997	Bowen ..... 220/254 X
D. 377,544	1/1997	Adriaansen .	5,896,993	4/1999	Nask et al. .... 220/254
D. 381,784	7/1997	Keller et al. .			
D. 403,583	1/1999	Nask et al. .... D9/435			
2,001,445	5/1935	Abele .			79229 Odor-Free Diaper System, Fisher-Price, 1998 Catalog (1 page).
2,532,165	11/1950	Hermani .			475 Gerry Flip-Top Diaper Pail, p. 59, date unknown (1 page).
2,563,456	8/1951	Brownell .			No. 41681 Odor-Less Diaper Pail System, Safety 1st, 1998 Catalog (1 page).
2,946,474	7/1960	Knapp .			No. 468 One Step Diaper Pail, Safety 1st, 1998 Catalog (1 page).
4,427,110	1/1984	Shaw, Jr. .			#4000 Diaper Champ™ The Easiest to Use Diaper Pail Available, Baby Trend, date unknown (1 page).
4,972,966	11/1990	Craft, Jr. .			3020 Foot Pedal Nursery Pail, The First Years, 1997 Catalog (1 page).
5,022,553	6/1991	Pontius .			3027 Quick and Easy Odor-Free Diaper Pail, The First Years, 1997 (1 page).
5,036,999	8/1991	Bitsch .			
5,111,938	5/1992	Soprano et al. .			
5,125,526	6/1992	Sumanis .			
5,147,055	9/1992	Samson et al. .			
5,163,579	11/1992	Jones .			
5,170,904	12/1992	Neuhaus .			
5,217,135	6/1993	Smith et al. .			
5,230,525	7/1993	Delmerico et al. .			

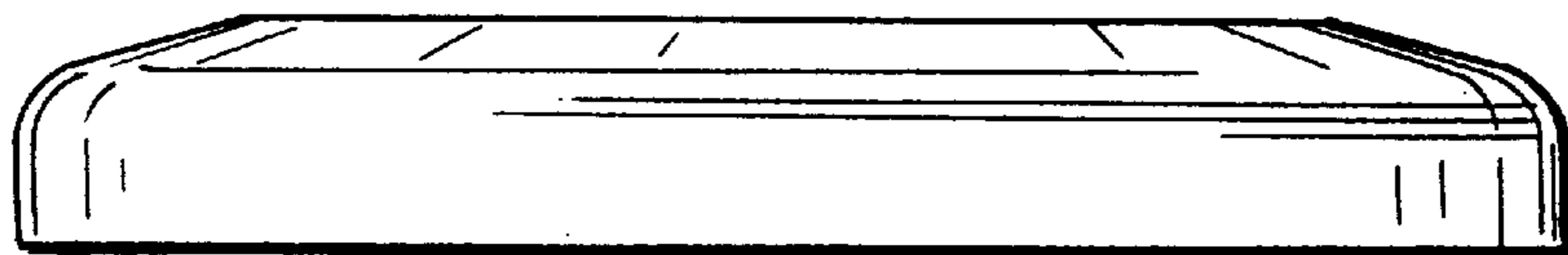
OTHER PUBLICATIONS



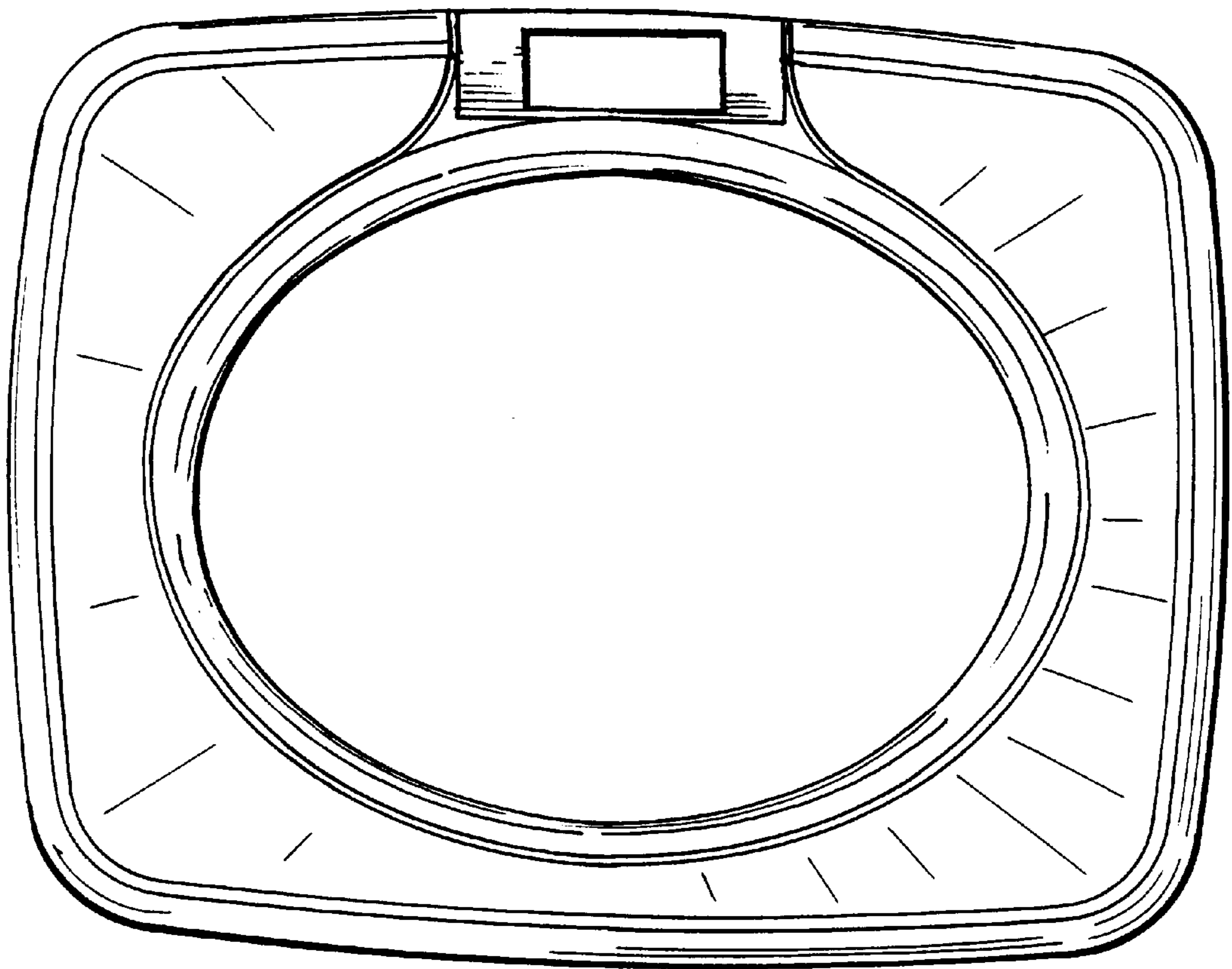
*FIG. 1*



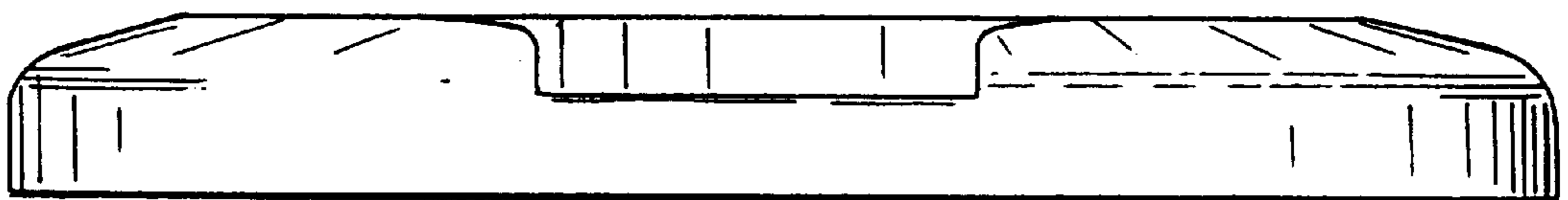
*FIG. 2*



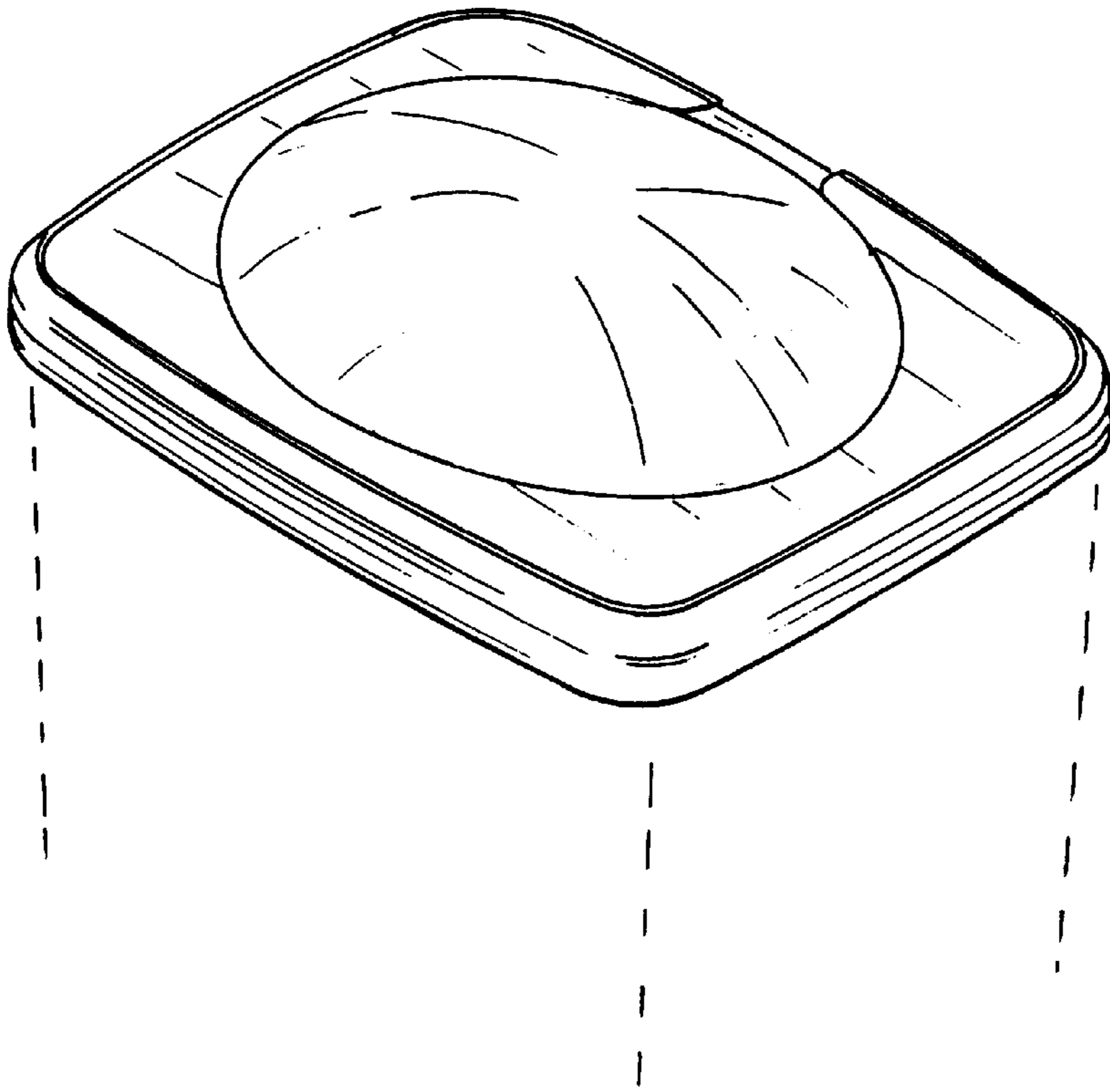
*FIG. 3*



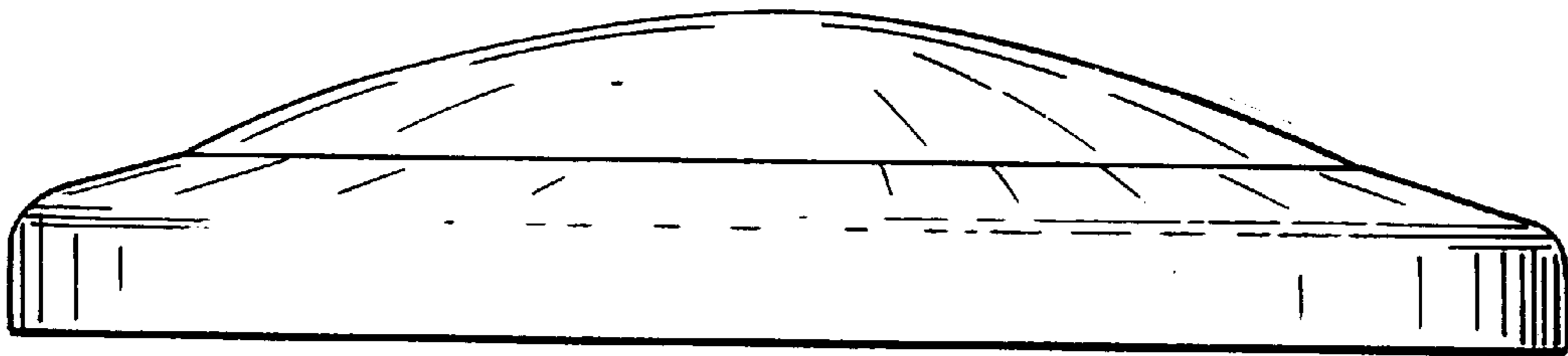
*FIG. 4*



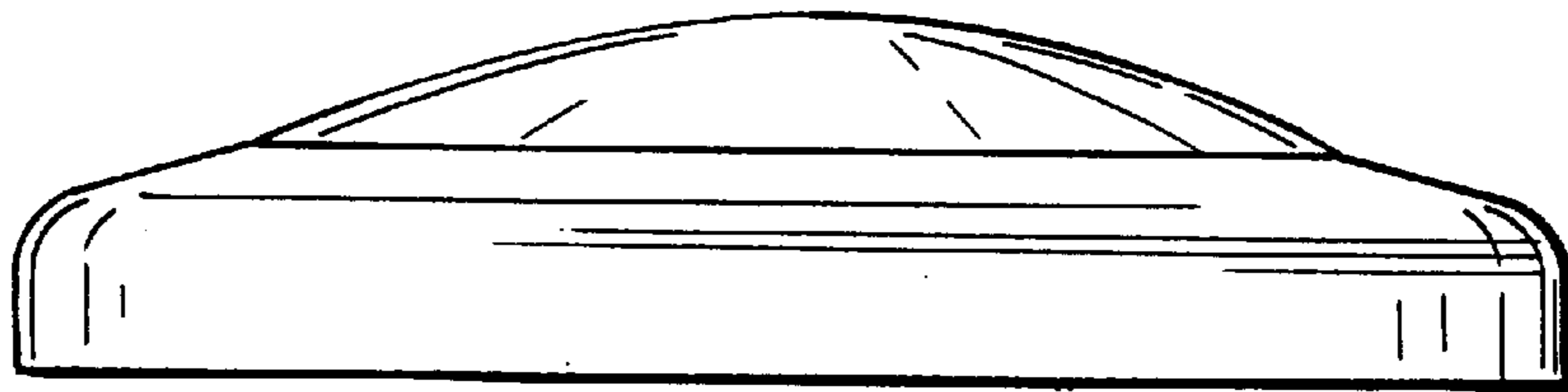
*FIG. 5*



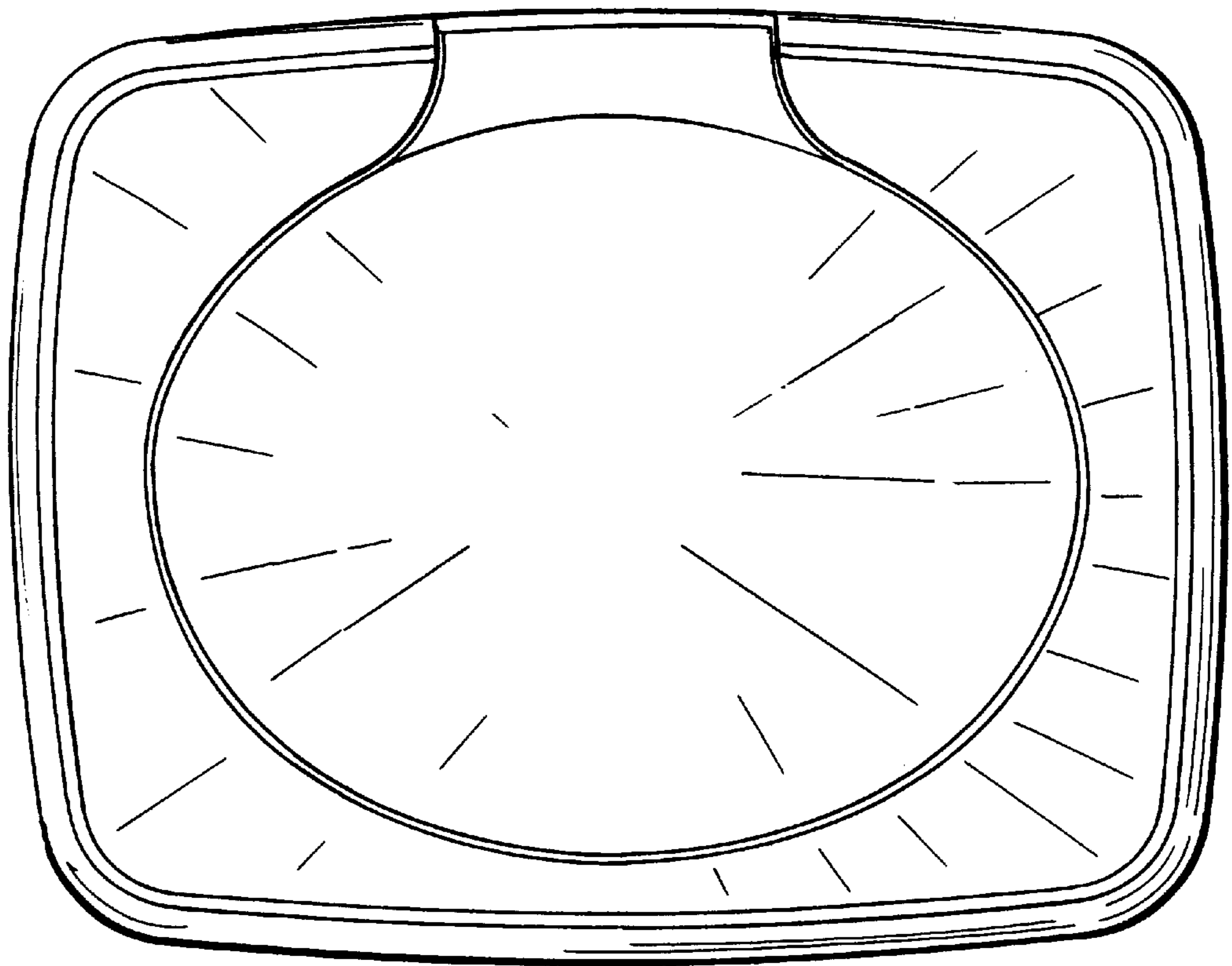
*FIG. 6*



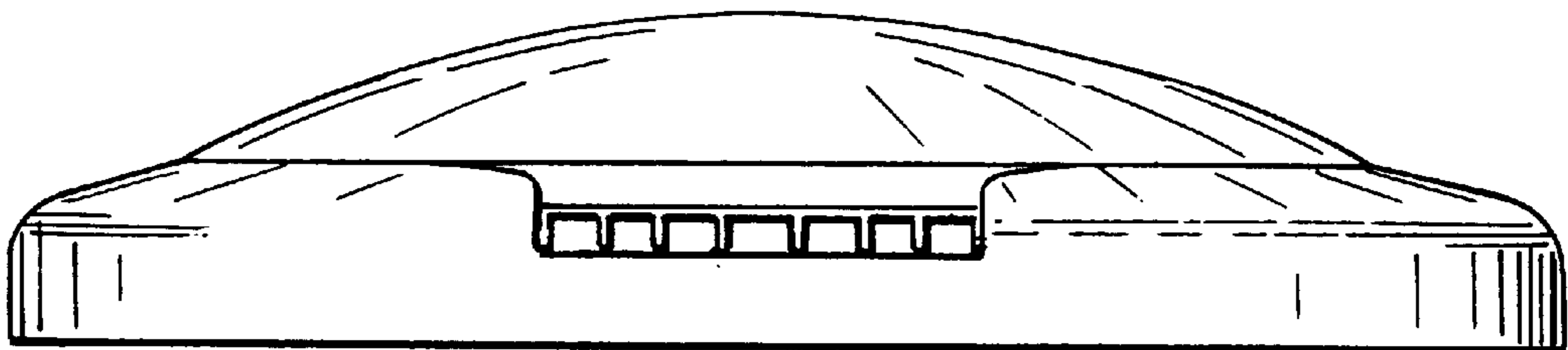
*FIG. 7*



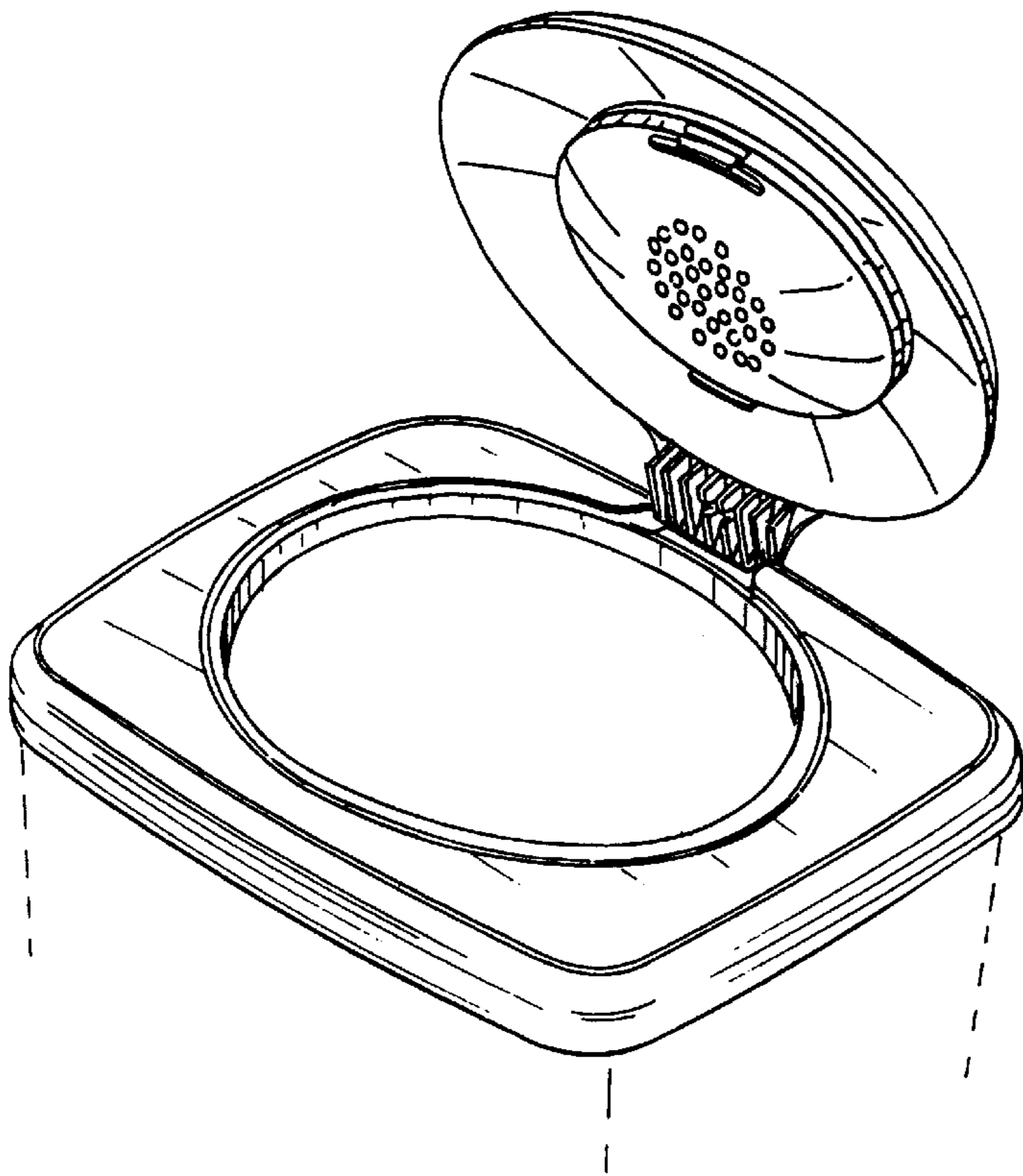
*FIG. 8*



*FIG. 9*

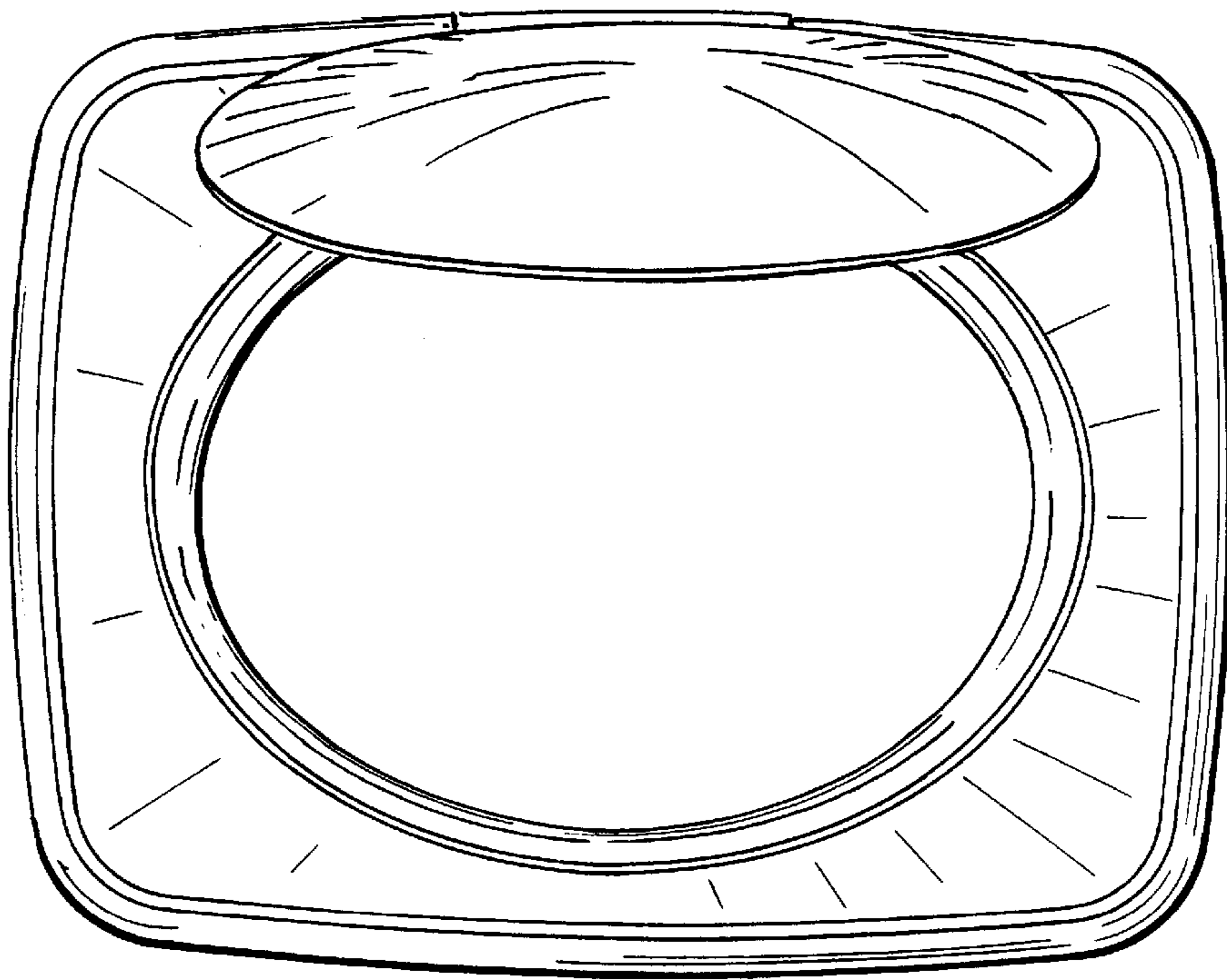


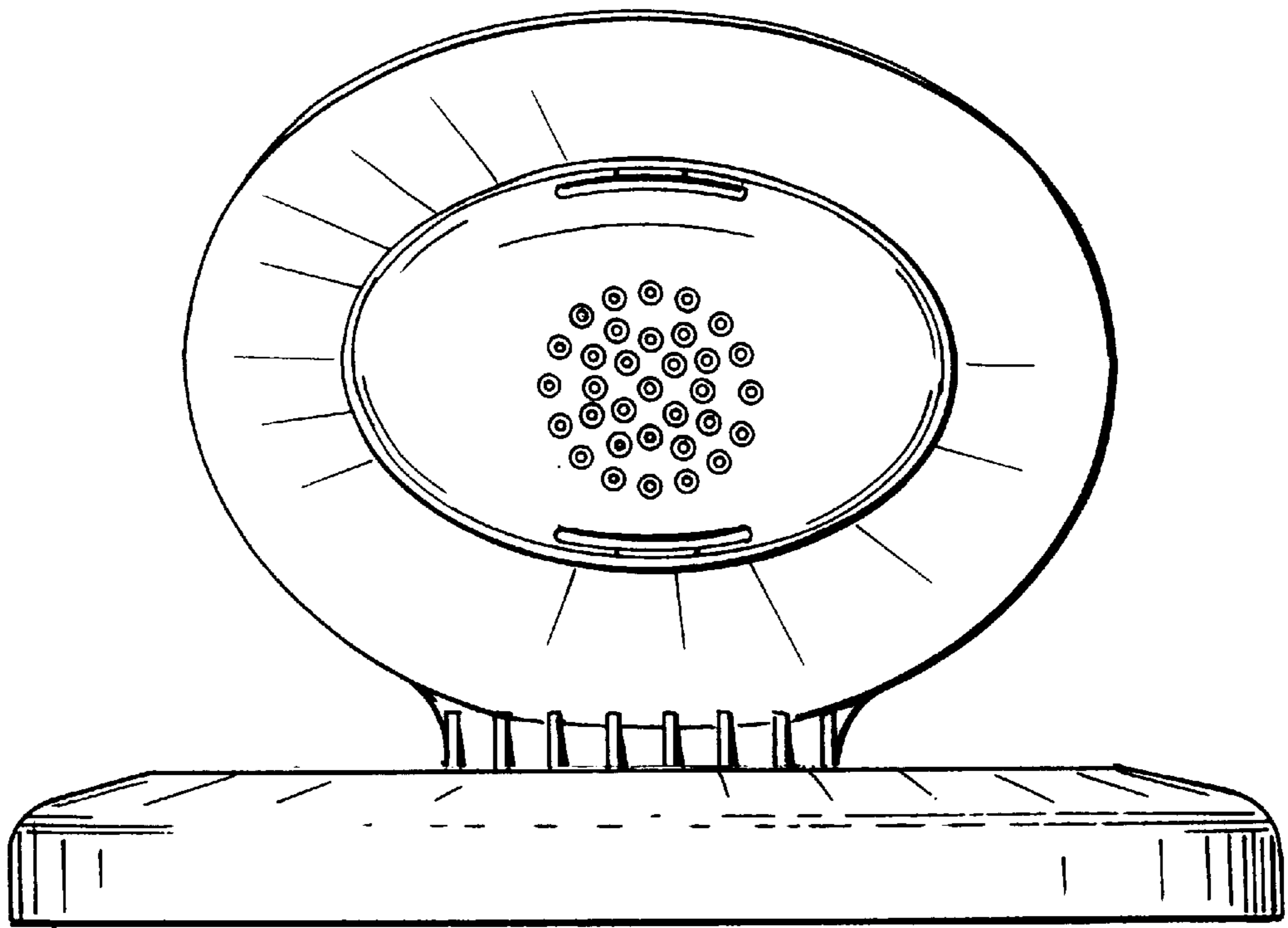
*FIG. 10*



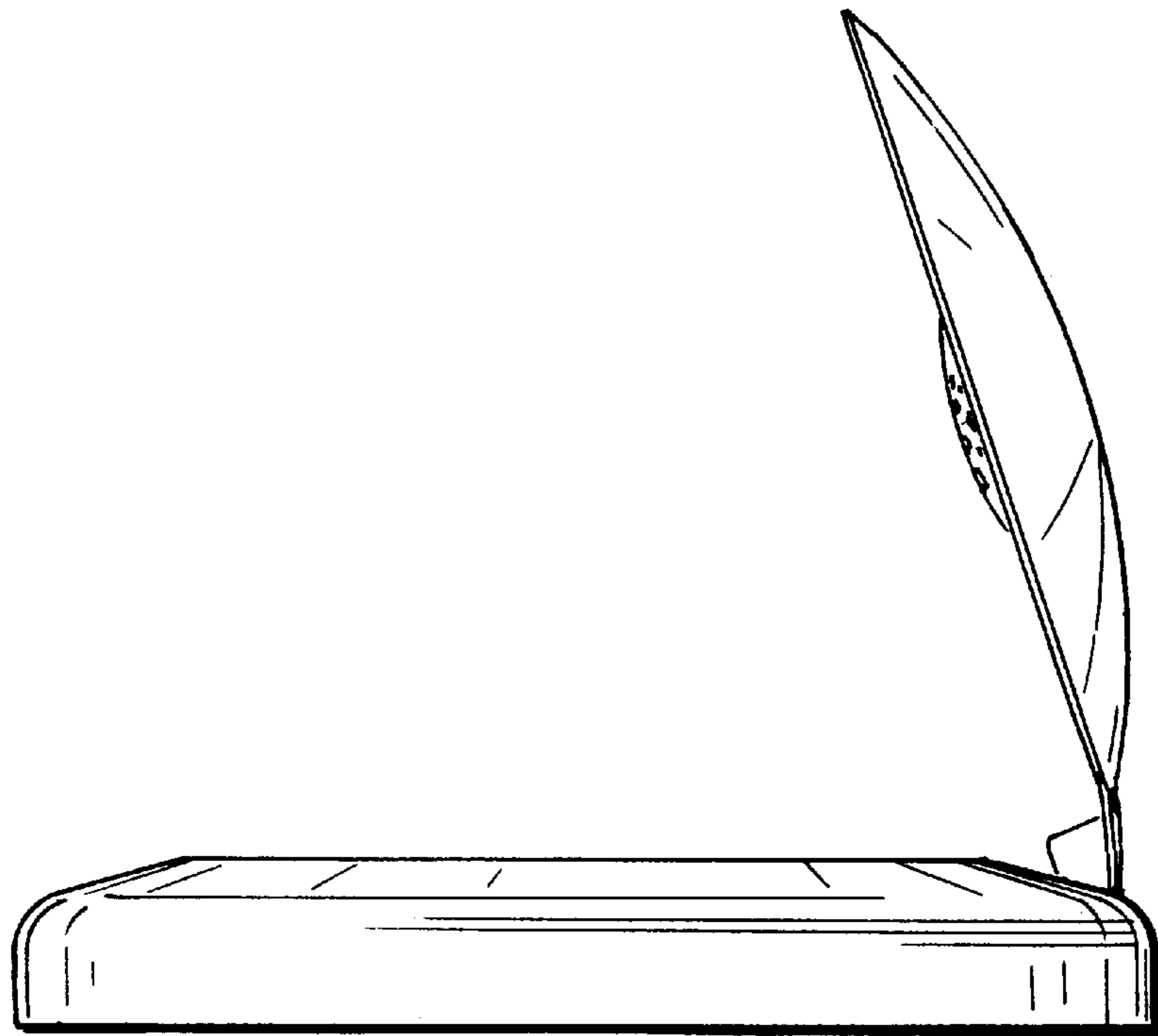
*FIG. 11*

*FIG. 12*



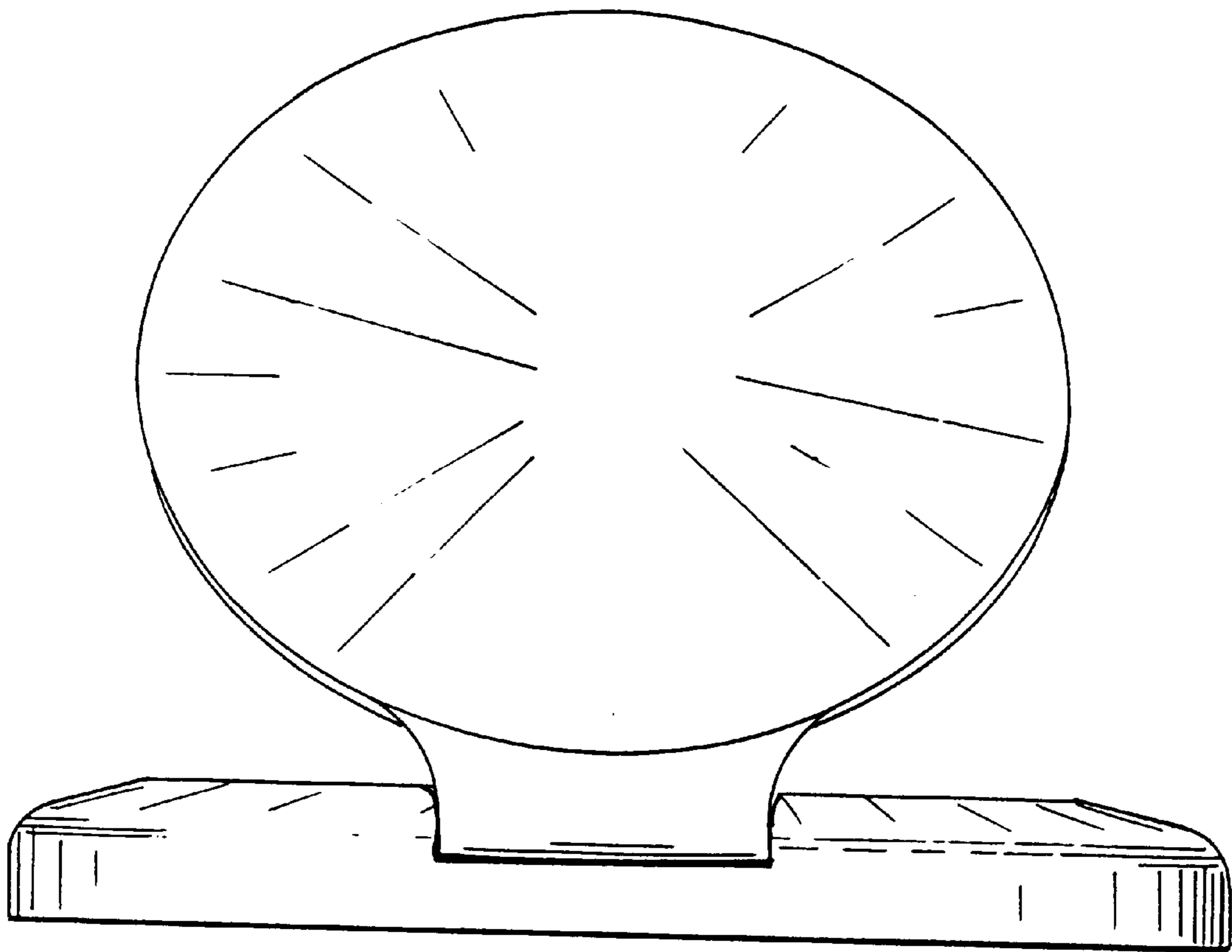


*FIG. 13*



*FIG. 14*





*FIG. 15*