



US00D431872S

United States Patent [19]
Lizardi

[11] **Patent Number: Des. 431,872**

[45] **Date of Patent: ** Oct. 10, 2000**

[54] **AIR COVER WINDOW SILL**

[75] Inventor: **Roberto Lizardi**, Buena Park, Calif.

[73] Assignee: **Allmet Building Products**, Buena Park, Calif.

[**] Term: **14 Years**

[21] Appl. No.: **29/116,388**

[22] Filed: **Jan. 3, 2000**

[51] **LOC (7) Cl.** **25-99**

[52] **U.S. Cl.** **D25/199**

[58] **Field of Search** 49/475.1, 482.1,
49/495.1; D25/199

[56] **References Cited**

U.S. PATENT DOCUMENTS

D. 417,295	11/1999	Trieste	D25/199
3,325,944	6/1967	Crain	49/475.1
3,517,472	6/1970	Toth	49/475.1
4,078,334	3/1978	Lambias	49/475.1

Primary Examiner—Doris Clark

Attorney, Agent, or Firm—Alexander & Yong

[57] **CLAIM**

The ornamental design for an air cover window sill, as shown and described.

DESCRIPTION

FIG. 1 is an isometric view of a first embodiment;

FIG. 2 is a front elevational view of the embodiment shown in FIG. 1;

FIG. 3 is a top plan view of the embodiment shown in FIG. 1, thereof;

FIG. 4 is a rear elevational view of the embodiment shown in FIG. 1, thereof;

FIG. 5 is a bottom plan view of the embodiment shown in FIG. 1, thereof;

FIG. 6 is a left side elevational view of the embodiment shown in FIG. 1, thereof;

FIG. 7 is a right side elevational view of the embodiment shown in FIG. 1, thereof;

FIG. 8 is an isometric view of a second embodiment;

FIG. 9 is a front elevational view of the embodiment shown in FIG. 8;

FIG. 10 is a top plan view of the embodiment shown in FIG. 8, thereof;

FIG. 11 is a rear elevational view of the embodiment shown in FIG. 8, thereof;

FIG. 12 is a bottom plan view of the embodiment shown in FIG. 8, thereof;

FIG. 13 is a left side elevational view of the embodiment shown in FIG. 8, thereof;

FIG. 14 is a right side elevational view of the embodiment shown in FIG. 8, thereof; and,

FIG. 15 is a perspective view of the embodiment shown in FIG. 1 and the embodiment shown in FIG. 8 as they are used with a window on a window sill.

The broken lines showing of a window and a portion of a window sill in FIG. 15 is for illustration purpose only and forms no part of the claimed design.

1 Claim, 5 Drawing Sheets

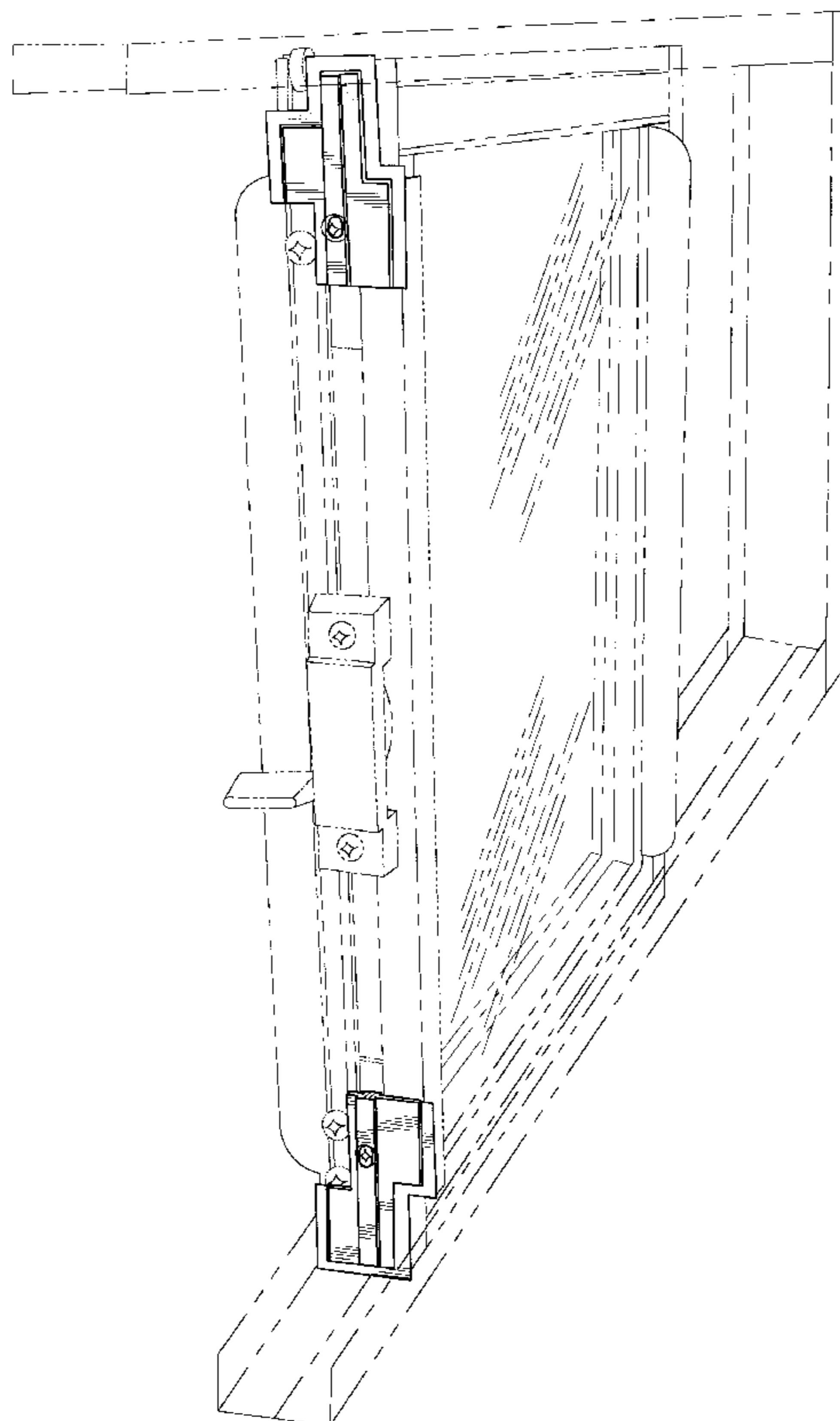

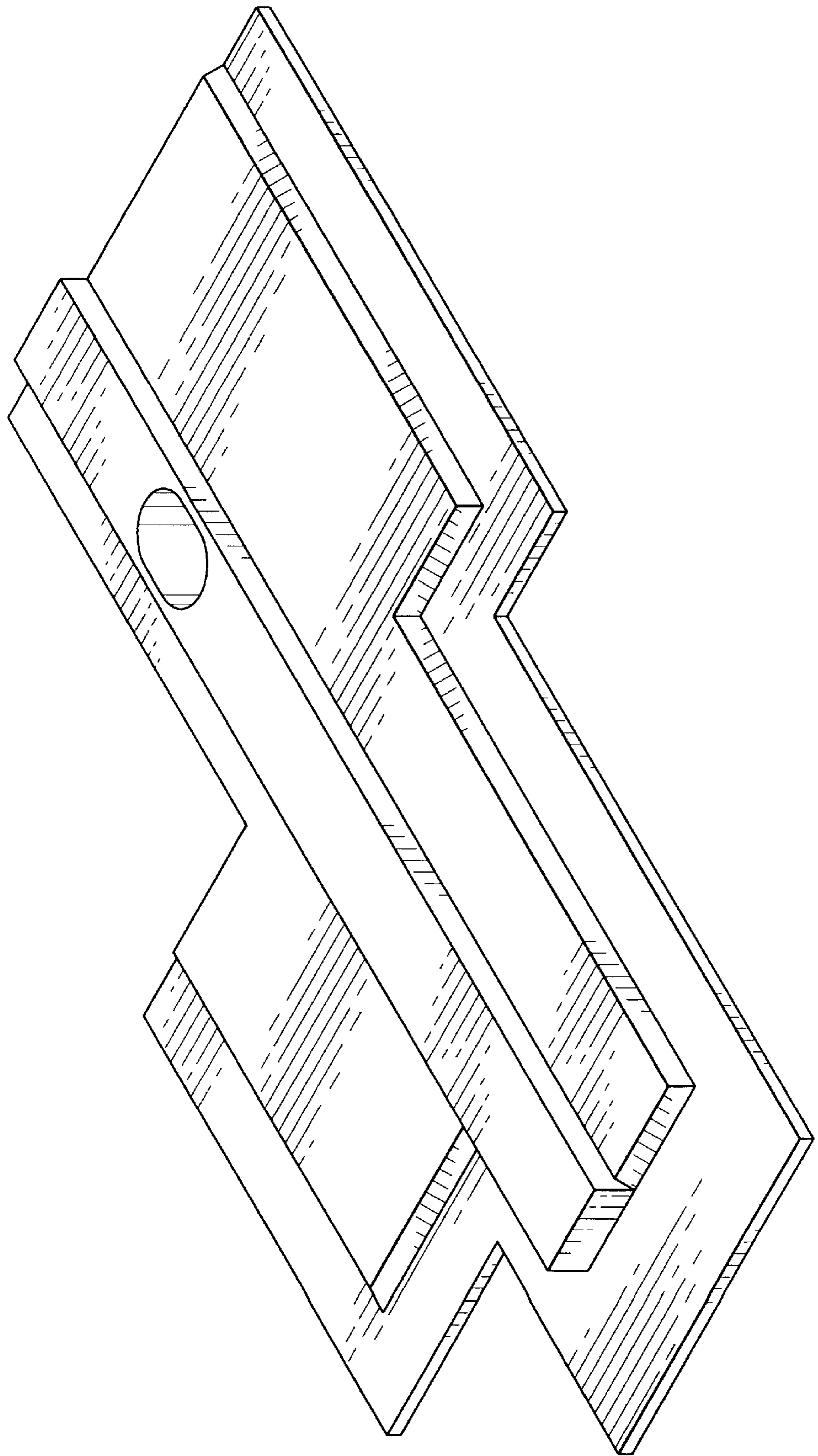

FIG. 1

FIG. 6

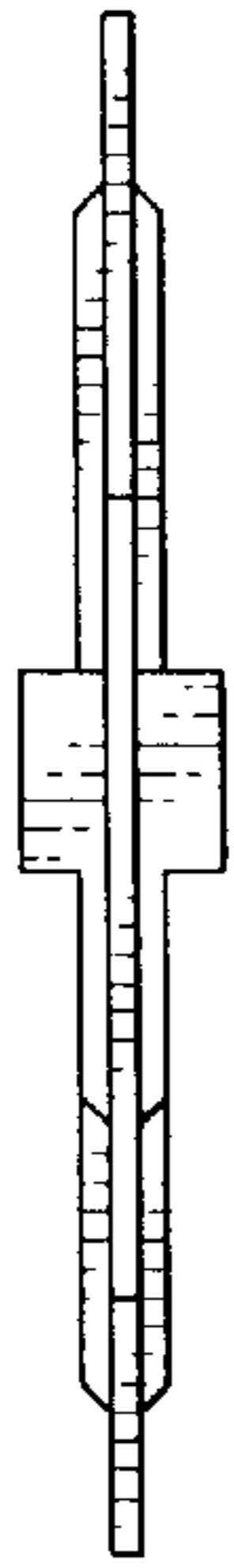

FIG. 2

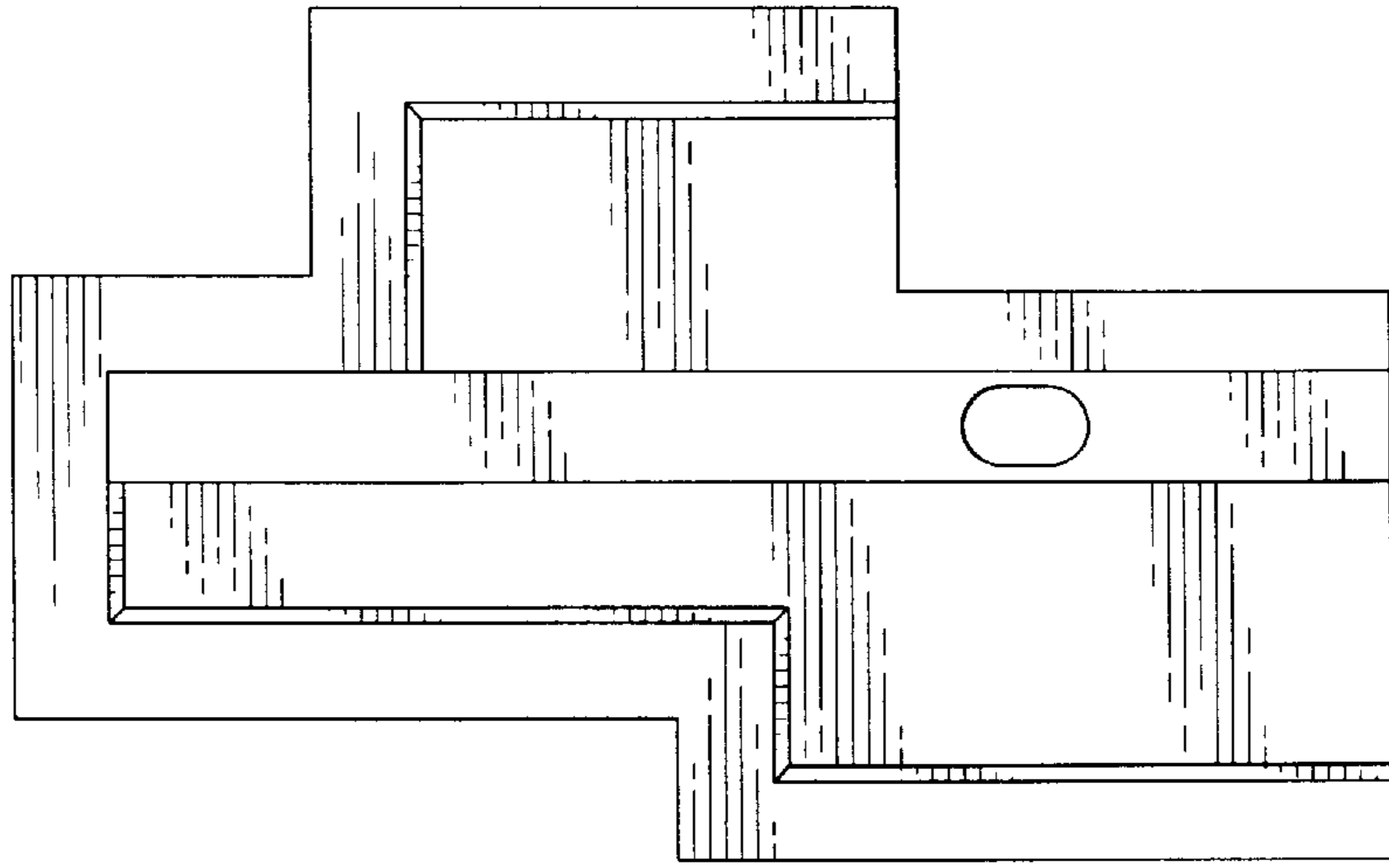

FIG. 7

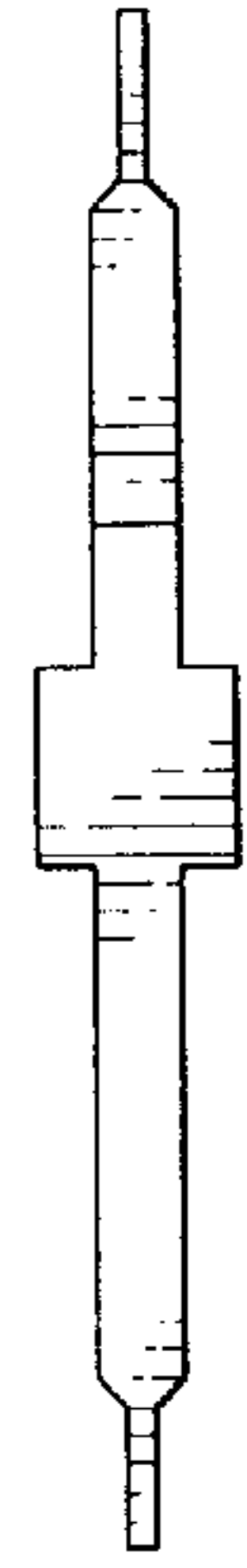

FIG. 3

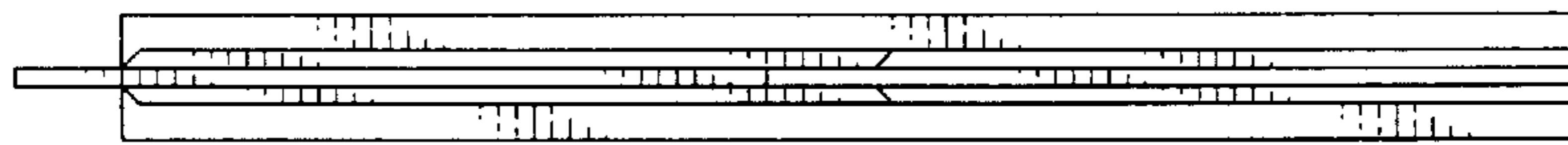

FIG. 4

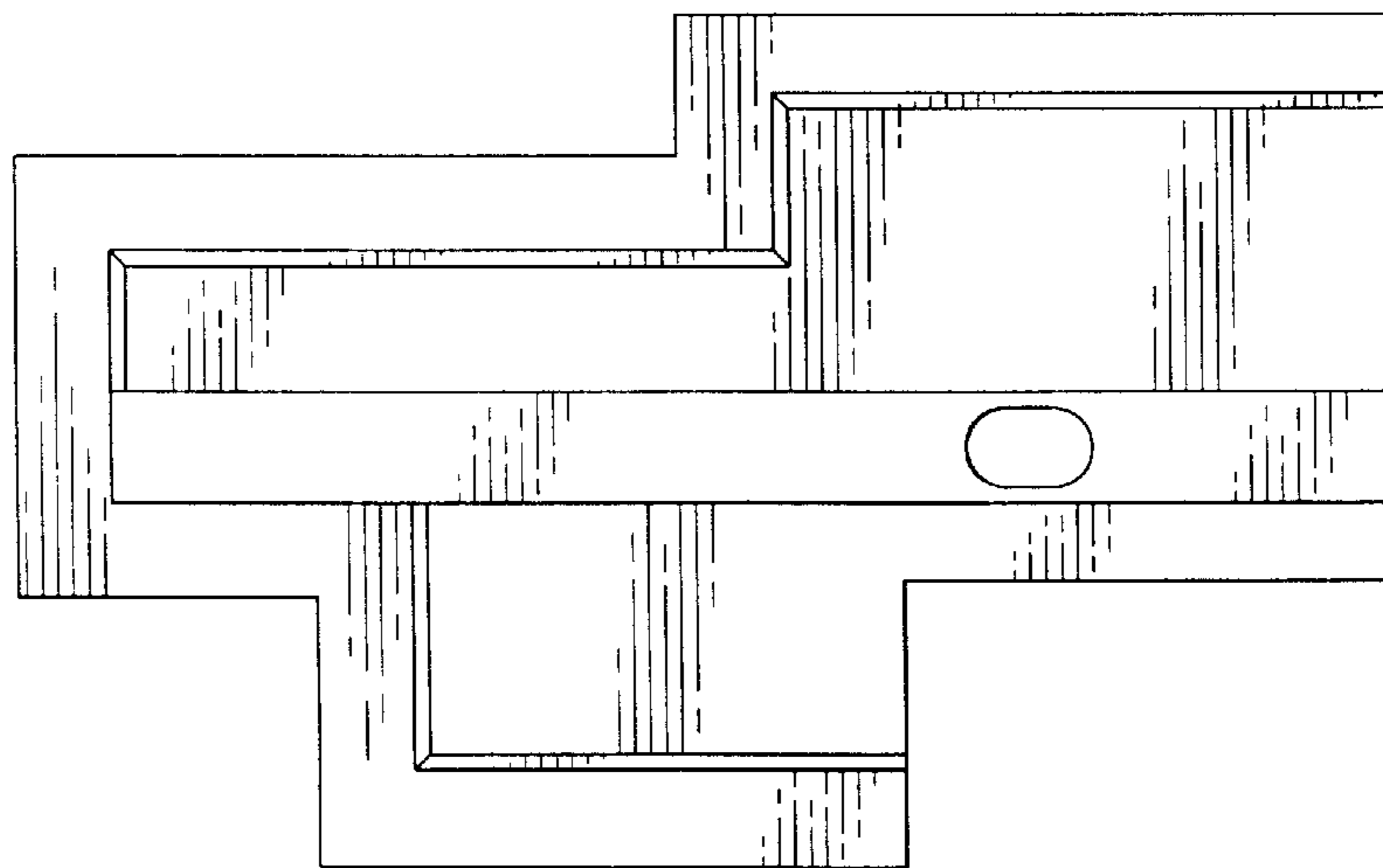
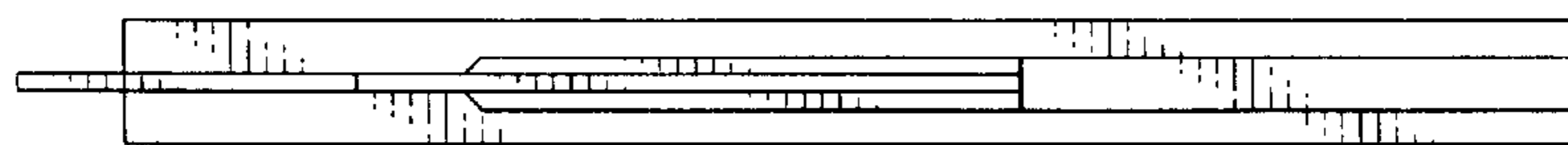

FIG. 5



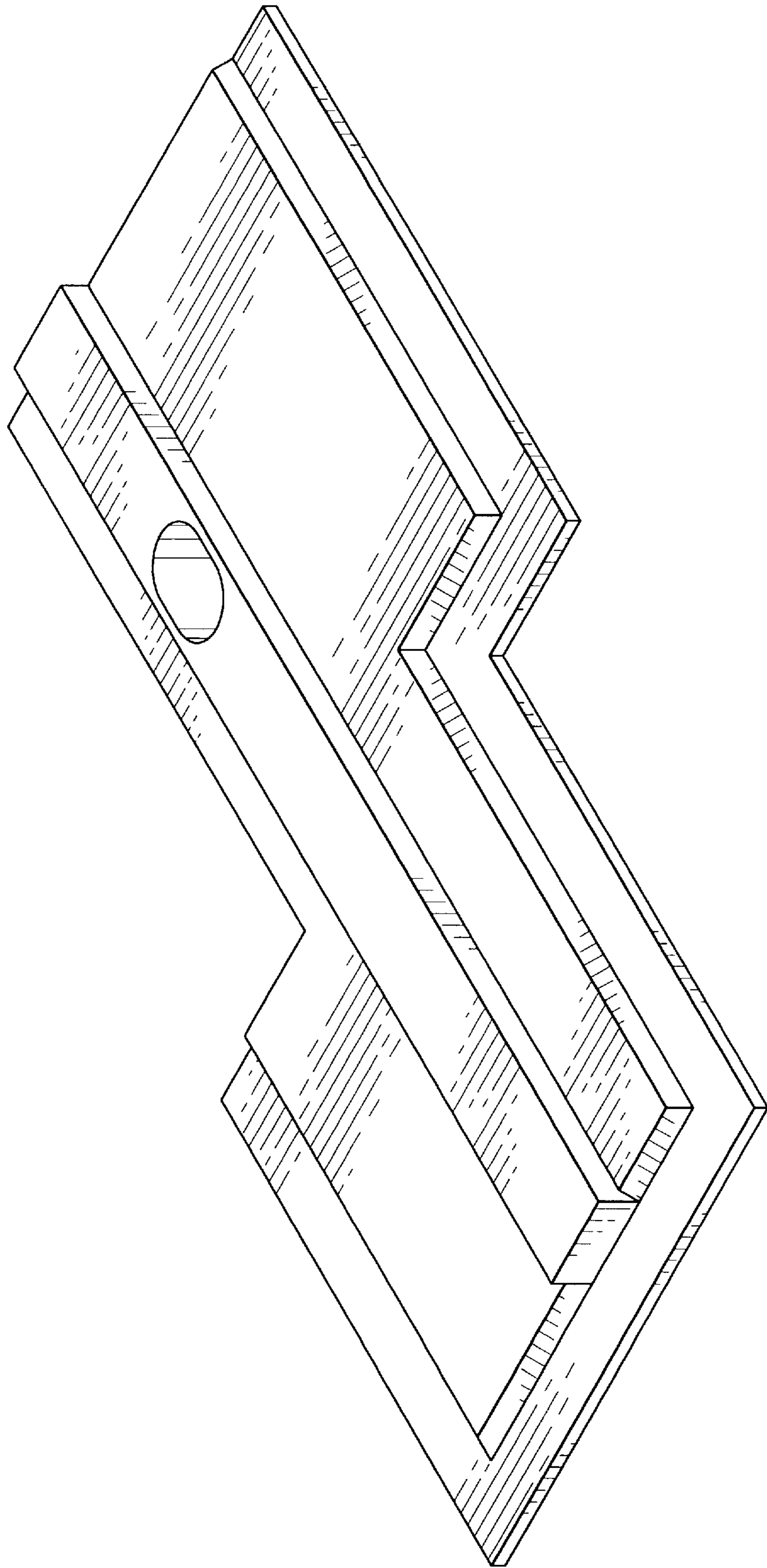

FIG. 8

FIG. 13

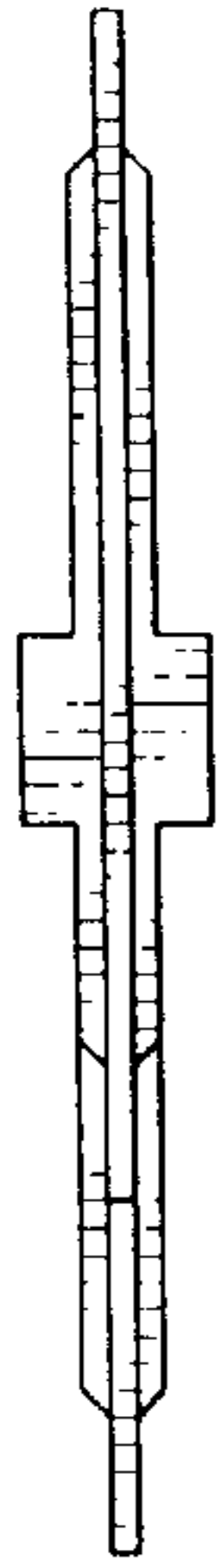

FIG. 9

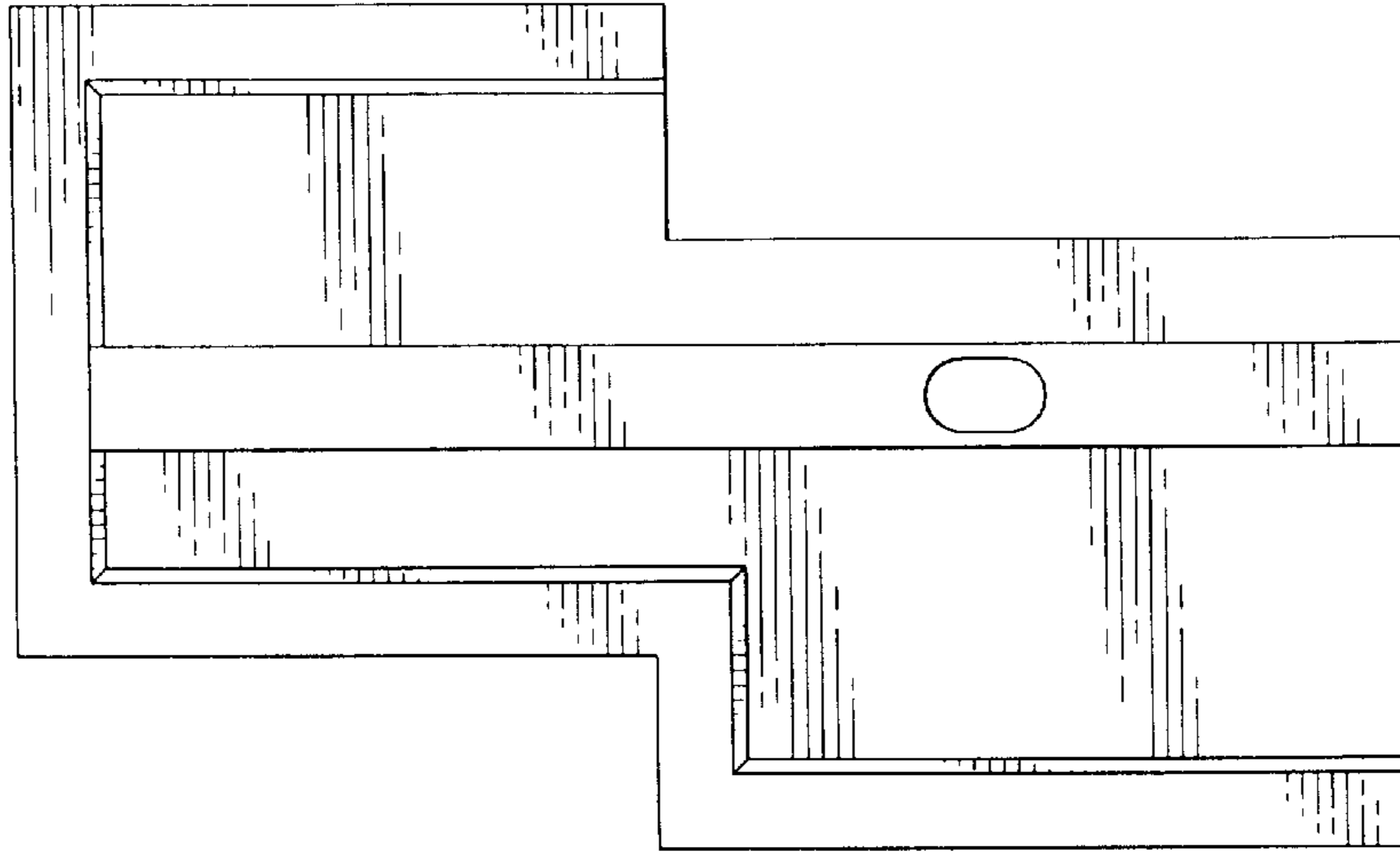

FIG. 14



FIG. 10

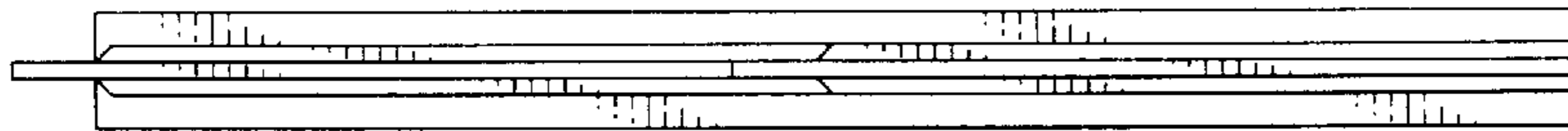

FIG. 11

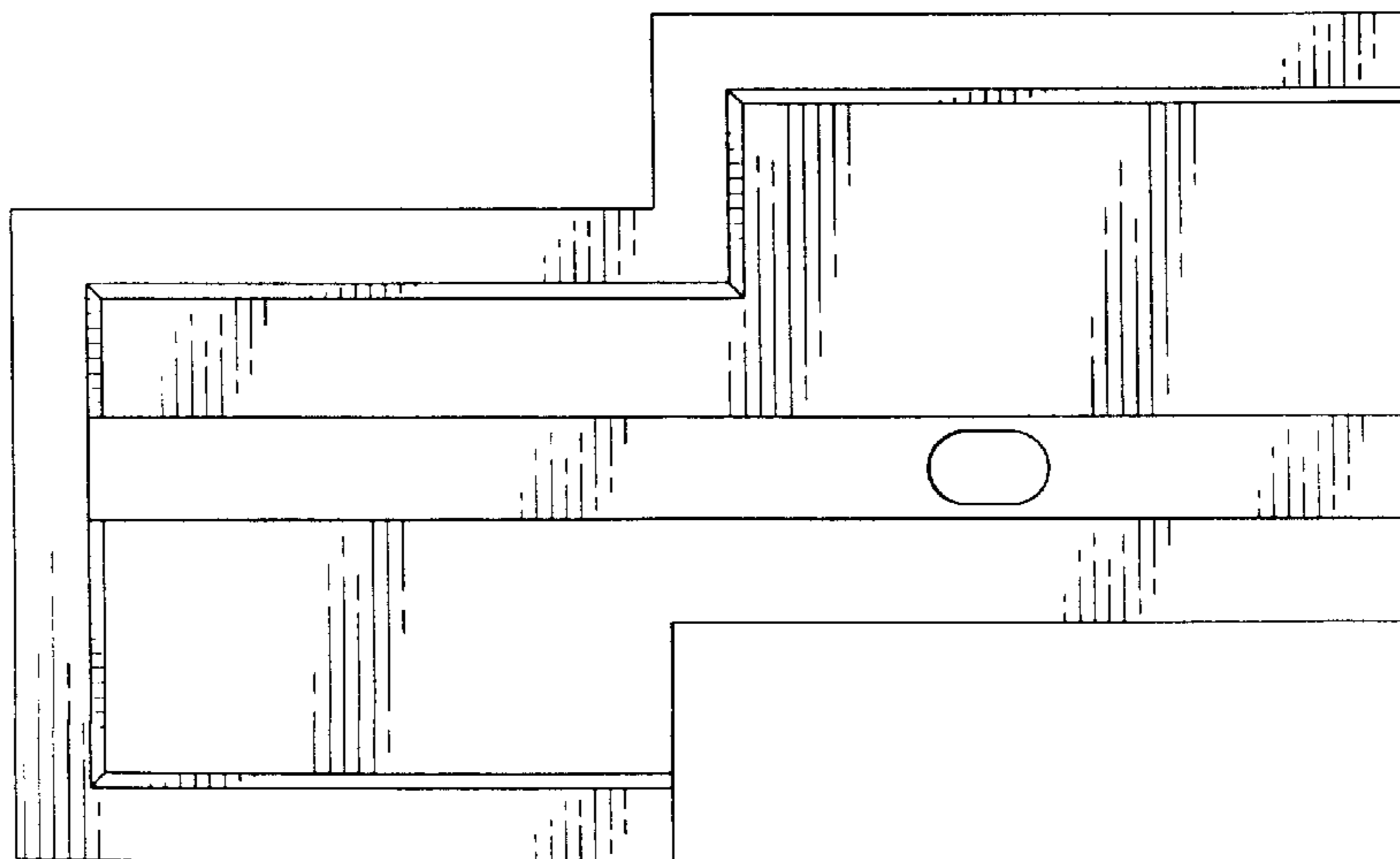
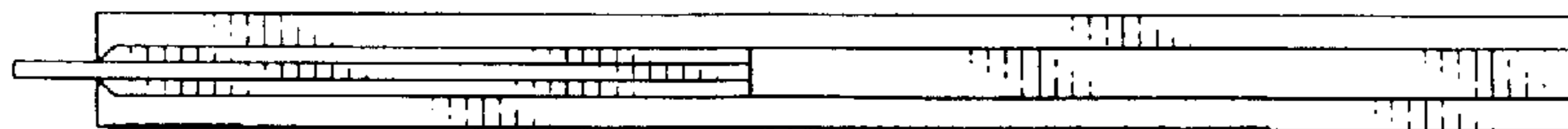

FIG. 12



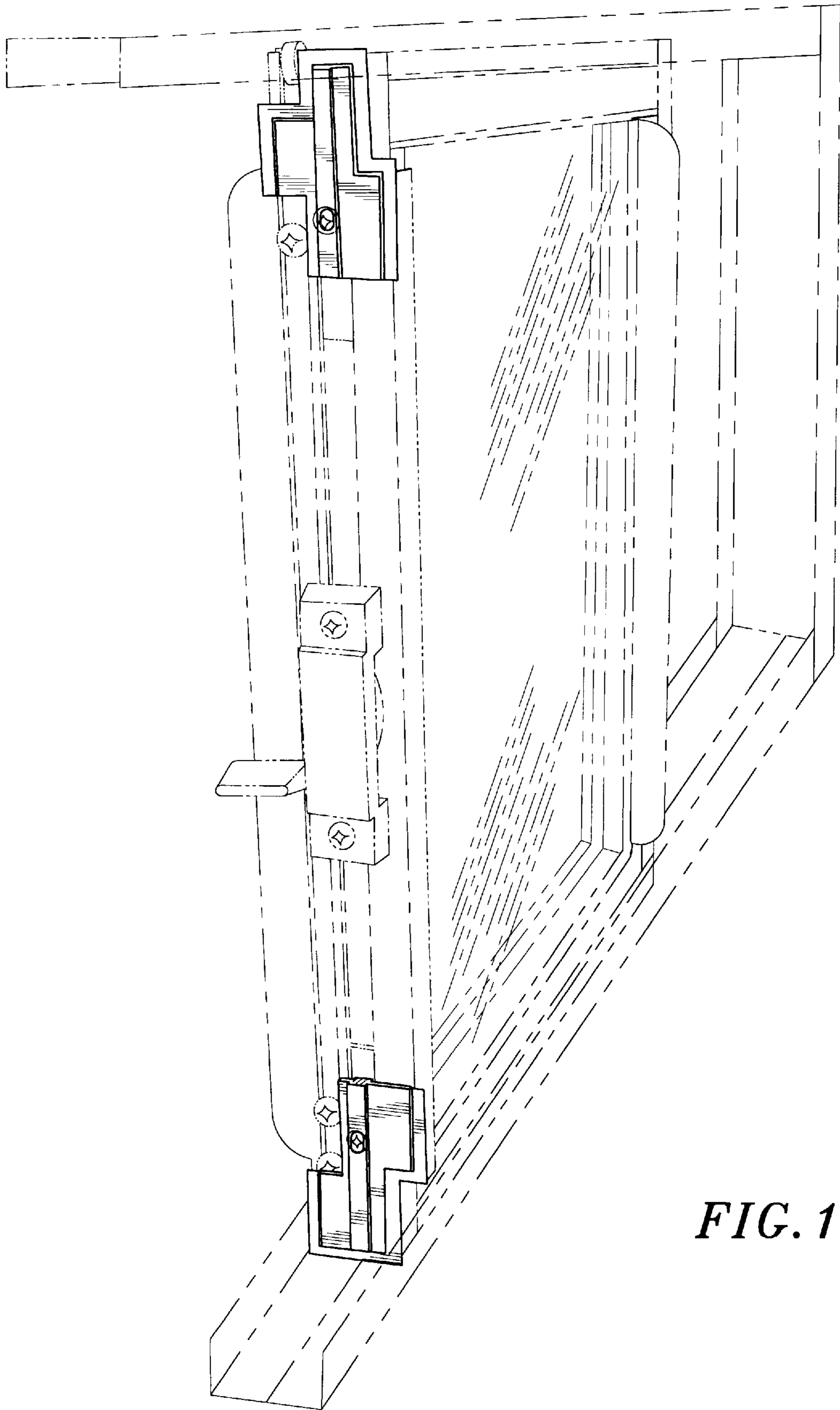

FIG. 15