



US00D431813S

United States Patent [19]

[11] **Patent Number: Des. 431,813**

Leman

[45] **Date of Patent: ** Oct. 10, 2000**

[54] FRONT BEZEL AND FOOT FOR A COMPUTER CHASSIS

DESCRIPTION

[75] Inventor: **Michael Leman**, Eagle, Id.

FIG. 1 is a right side elevation view of a front bezel and foot for a computer chassis showing my design. Features shown in broken lines are for illustrative purposes only and form no part of the invention.

[73] Assignee: **Micron Electronics, Inc.**, Nampa, Id.

FIG. 2 is a front elevation view of a front bezel and foot for a computer chassis showing my design. Features shown in broken lines are for illustrative purposes only and form no part of the invention.

[**] Term: **14 Years**

[21] Appl. No.: **29/106,117**

FIG. 3 is a rear elevation view of a front bezel and foot for a computer chassis showing my design. Features shown in broken lines are for illustrative purposes only and form no part of the invention.

[22] Filed: **Jun. 9, 1999**

[51] **LOC (7) Cl.** **14-02**

[52] **U.S. Cl.** **D14/115**

[58] **Field of Search** D14/100, 102, D14/107-109, 257, 258; D13/162, 184, 199, 164, 177; D10/103; 312/223.2; 361/690-696

FIG. 4 is a top plan view of a front bezel for a computer chassis showing my design. Features shown in broken lines are for illustrative purposes only and form no part of the invention.

[56] **References Cited**

U.S. PATENT DOCUMENTS

D. 381,327 7/1997 Su D14/115
D. 390,216 2/1998 Lai D14/115

FIG. 5 is a left front isometric view of a front bezel and foot for a computer chassis showing my design. Features shown in broken lines are for illustrative purposes only and form no part of the invention; and,

Primary Examiner—Freda Nunn

Attorney, Agent, or Firm—Perkins Coie LLP

FIG. 6 is a bottom rear right isometric view of a front bezel and foot for a computer chassis showing my design. Features shown in broken lines are for illustrative purposes only and form no part of the invention.

[57] **CLAIM**

The ornamental design for a front bezel and foot for a computer chassis, as shown and described.

1 Claim, 3 Drawing Sheets

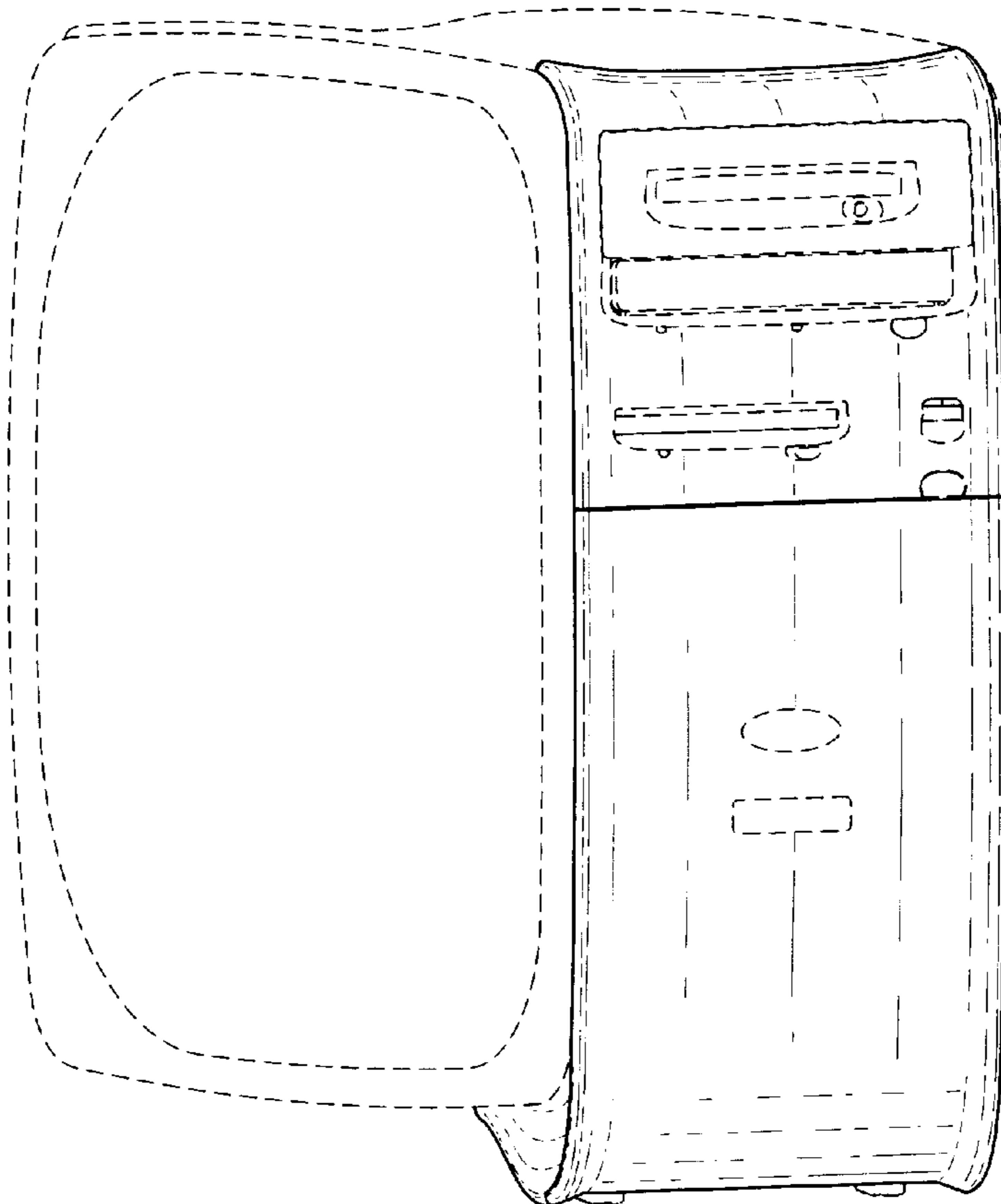

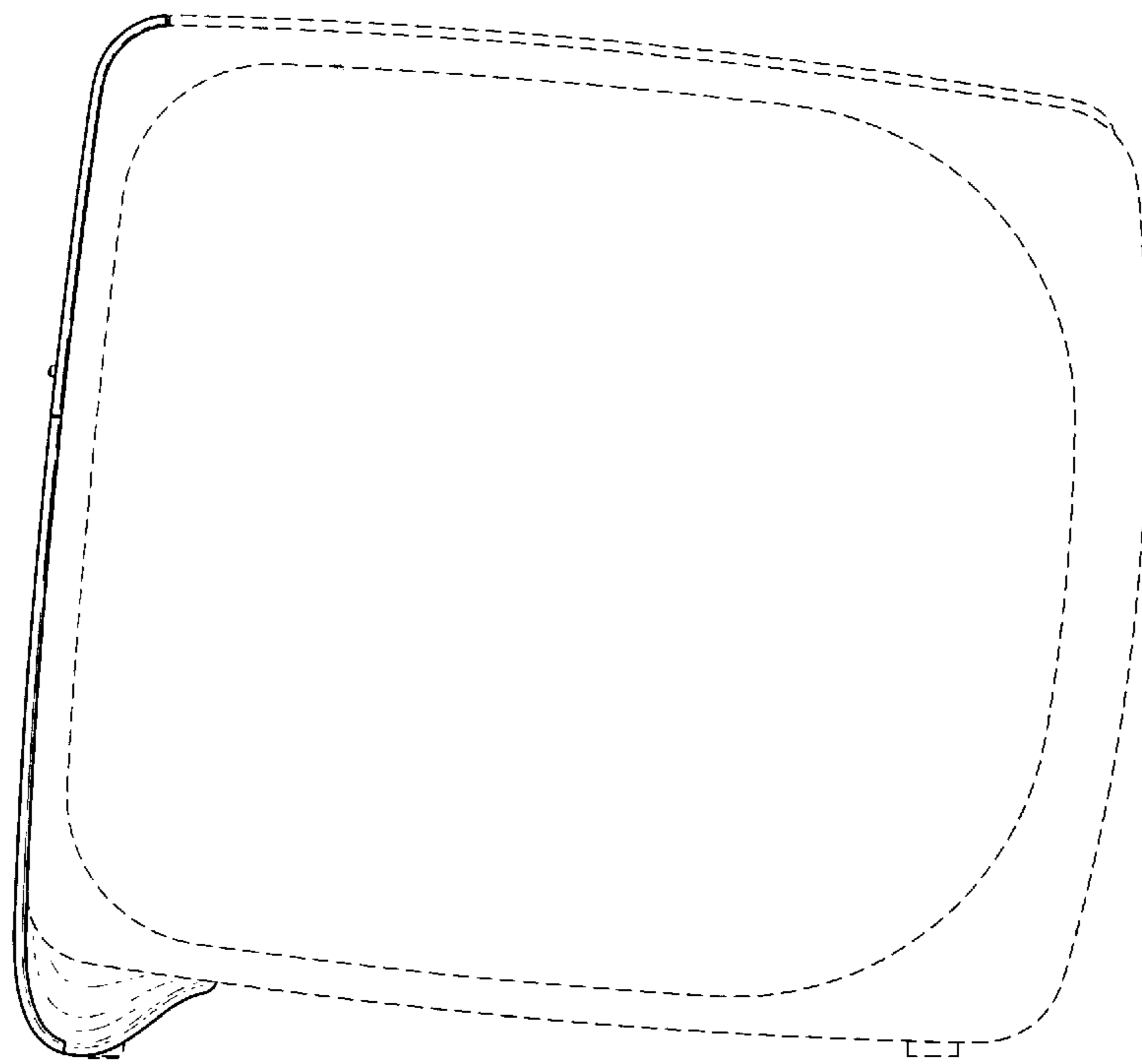

Fig. 1

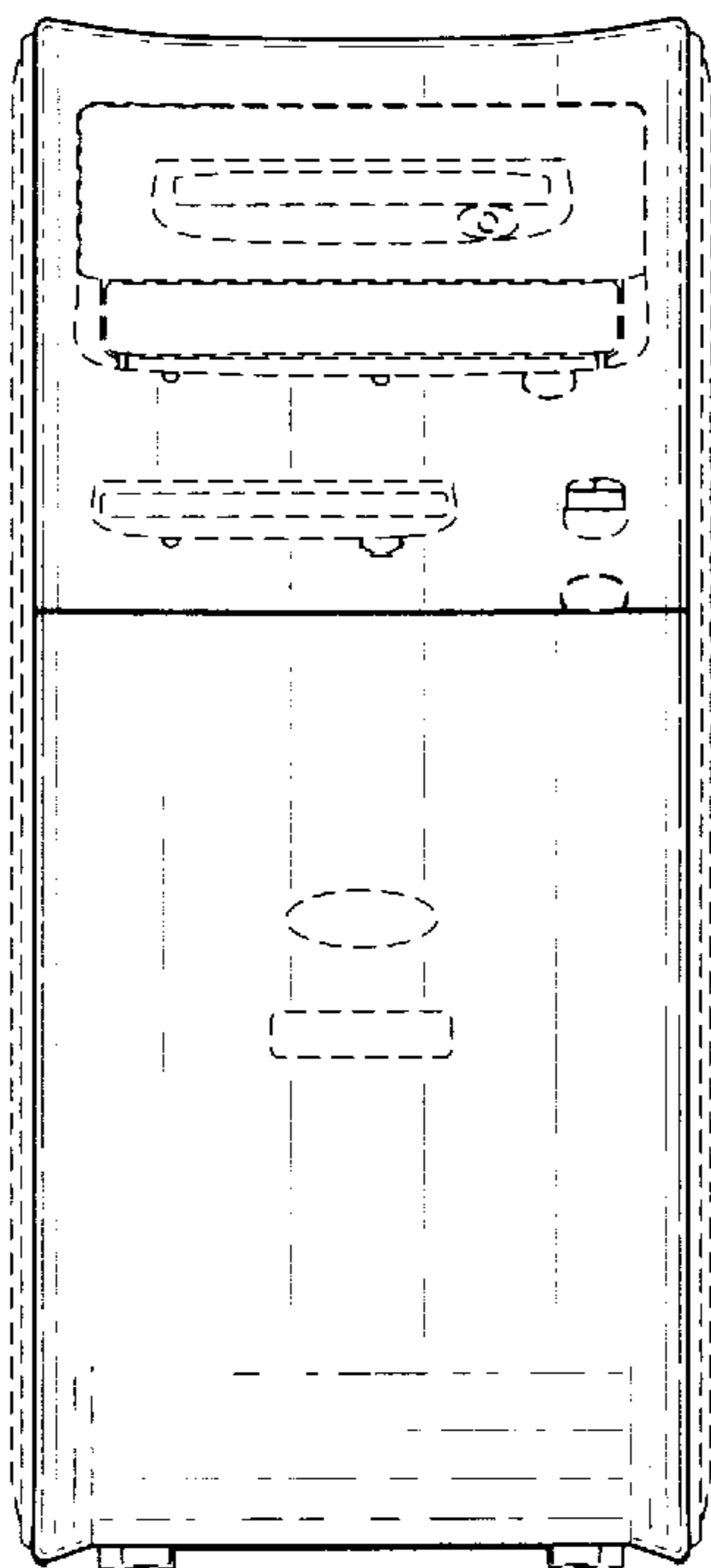

Fig. 2

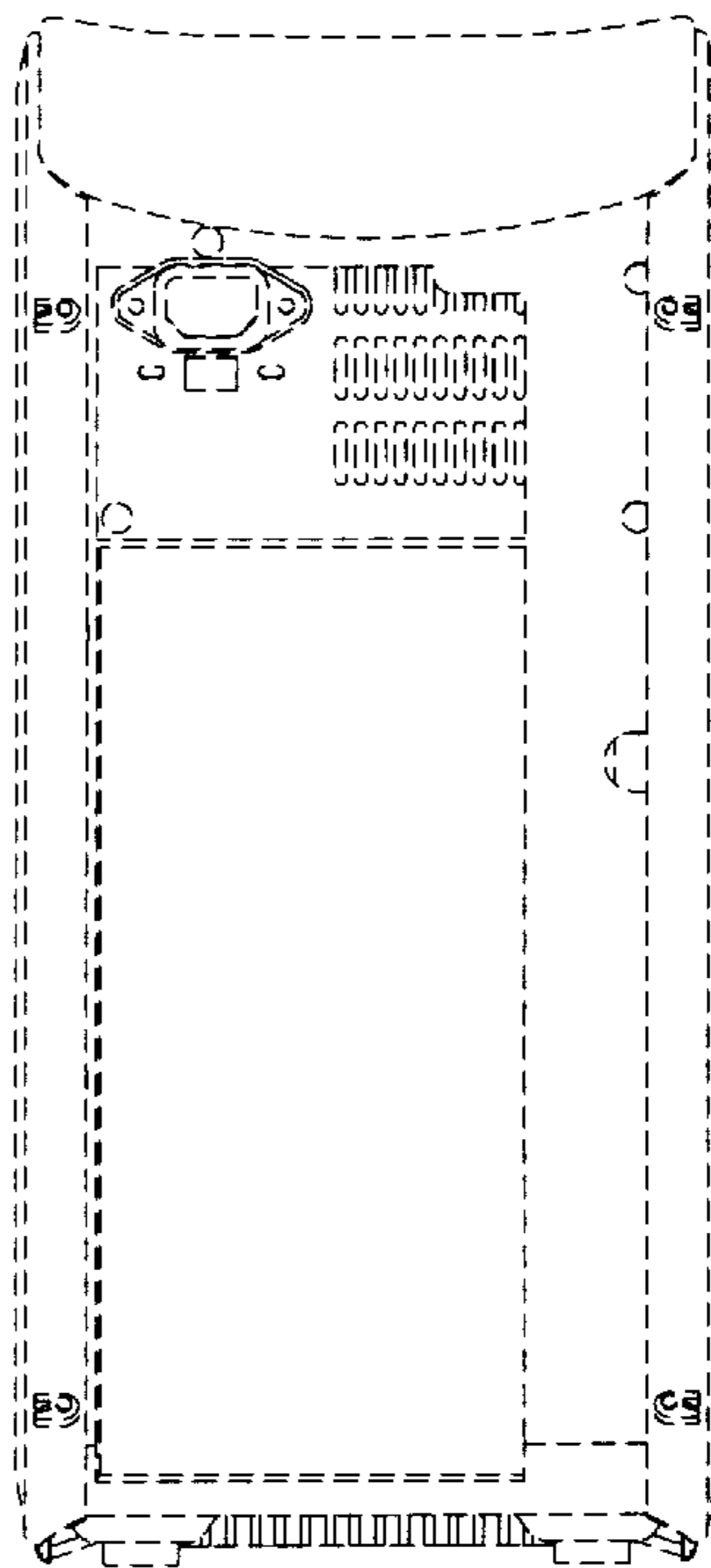

Fig. 3

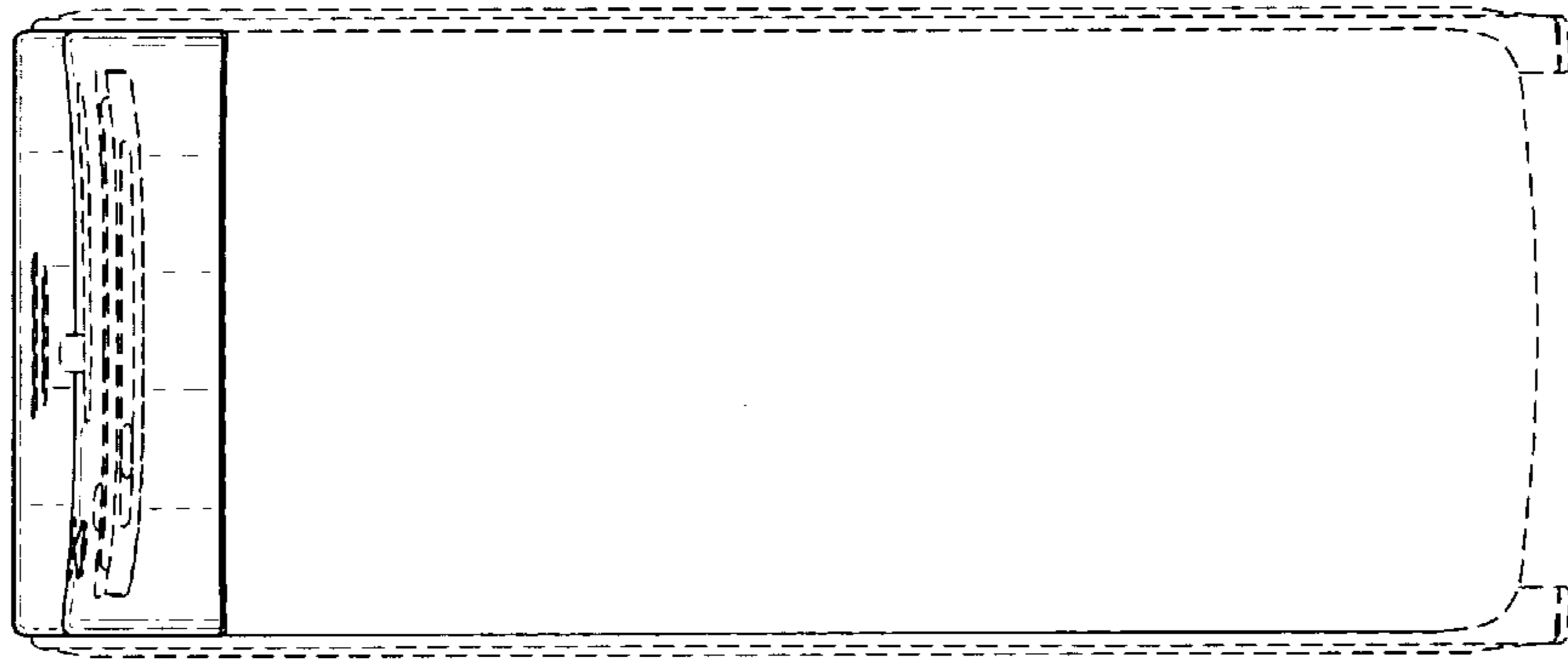

Fig. 4

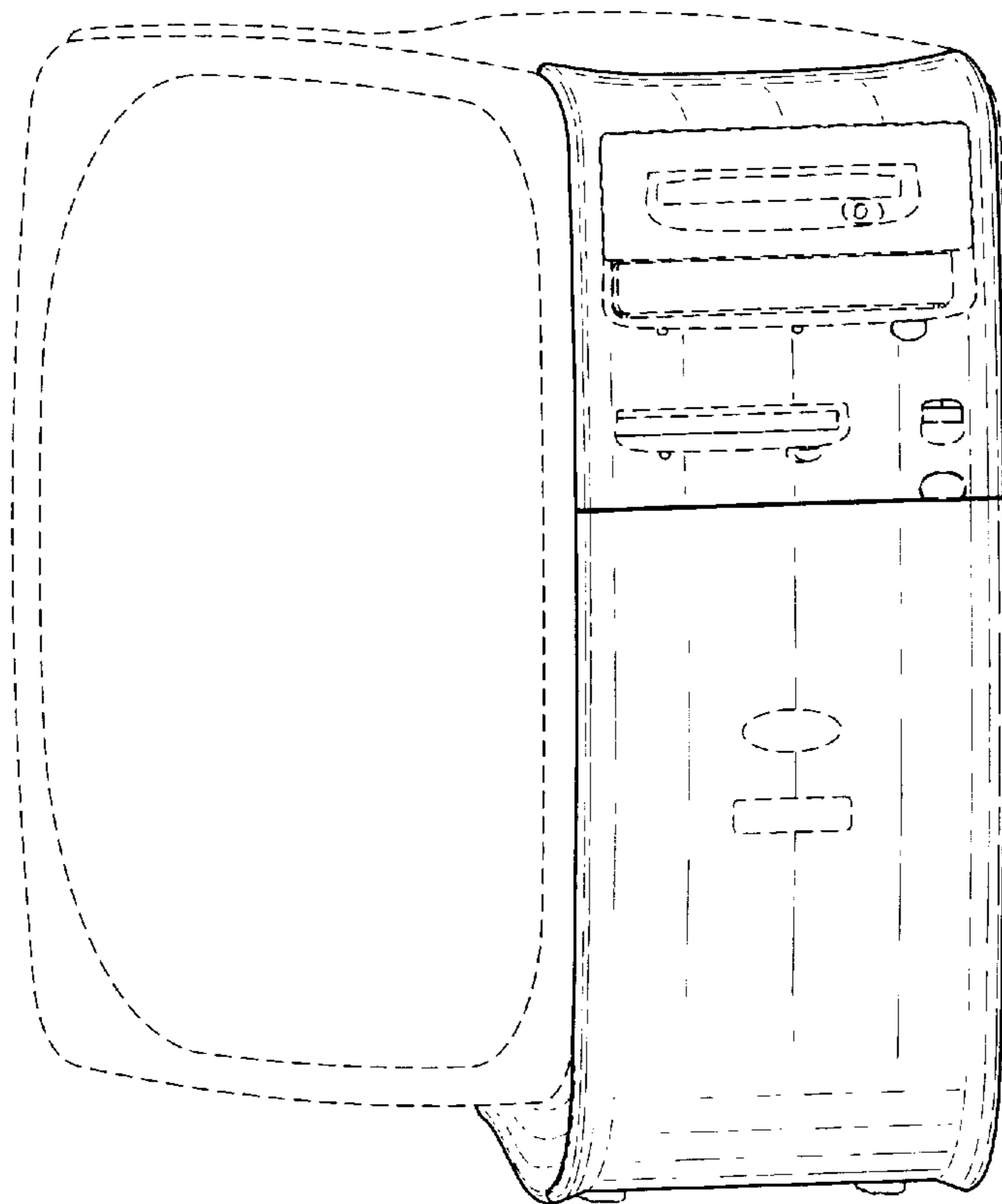

Fig. 5

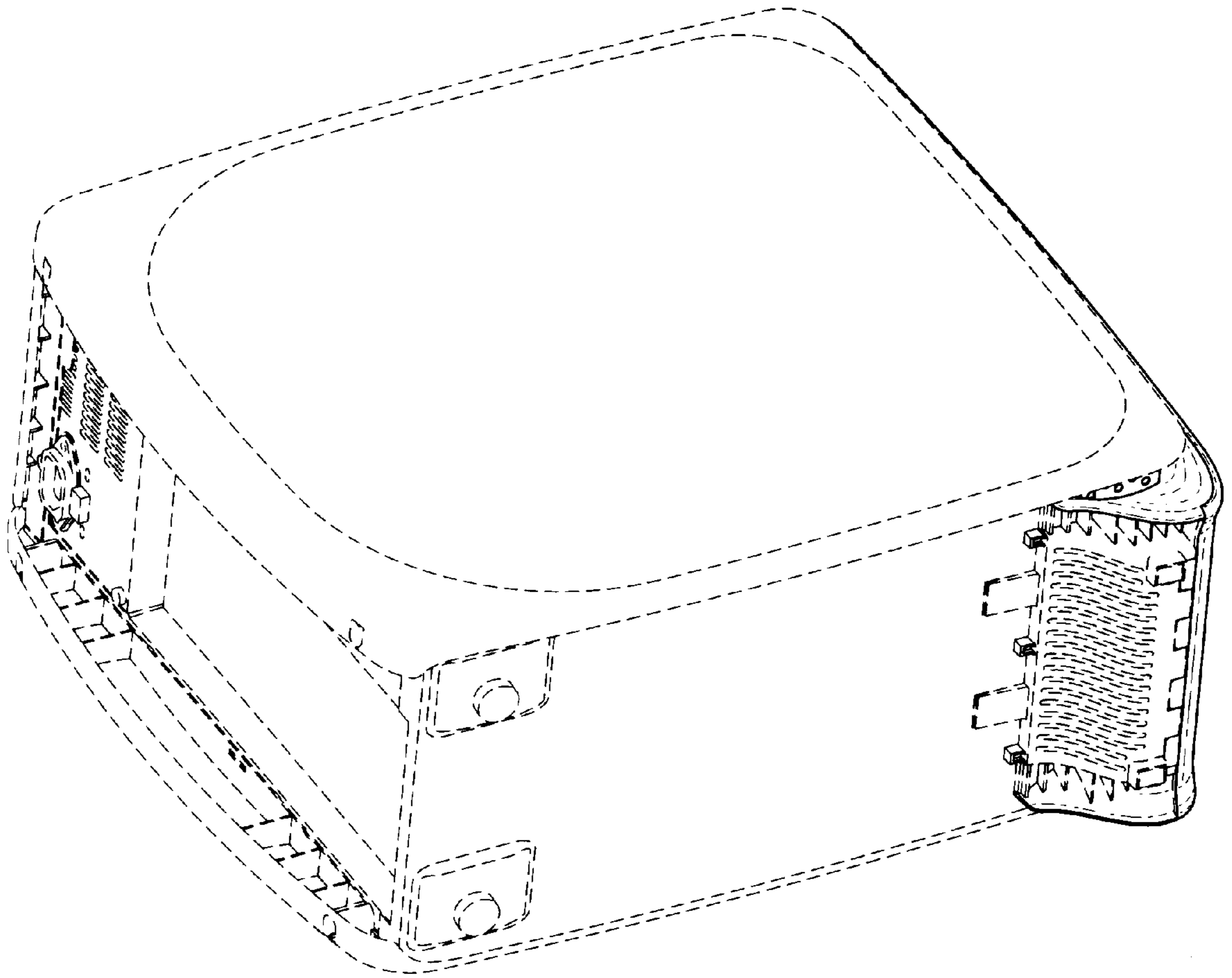

Fig. 6