



US00D431777S

United States Patent [19]
Marciano

[11] **Patent Number: Des. 431,777**

[45] **Date of Patent: ** Oct. 10, 2000**

[54] **PRESENTATION BOX FOR WRISTWATCH**

5,358,134 10/1994 Ripley et al. 220/787
5,547,076 8/1996 Doi et al. 206/301

[76] Inventor: **Moshe Marciano**, 18 Basing Street,
London W11 1ES, United Kingdom

Primary Examiner—Prabhakar Deshmukh

[**] Term: **14 Years**

[57] **CLAIM**

[21] Appl. No.: **29/083,888**

The ornamental design for a presentation box for wrist-
watch, as shown and described.

[22] Filed: **Feb. 19, 1998**

DESCRIPTION

[30] **Foreign Application Priority Data**

Aug. 29, 1997 [XH] Hague Agreement DM041222

[51] **LOC (7) Cl.** **09-07**

[52] **U.S. Cl.** **D9/422; D9/418**

[58] **Field of Search** D9/414, 415, 418,
D9/422, 430, 431, 337; 206/301, 6.1, 566,
335, 464, 45.28; 220/4.21, 4.24, 4.25, 252,
812

FIG. 1 is a top view of my new design for a presentation box
for a wristwatch;
FIG. 2 is a bottom view thereof;
FIG. 3 is a right side view thereof;
FIG. 4 is a left side view thereof;
FIG. 5 is a top, right, perspective view thereof;
FIG. 6 is a top, right, perspective view thereof, shown with
the lid partially open;
FIG. 7 is a top view of the presentation box, shown with the
lid partially open;
FIG. 8 is a top view of the lid and base of the presentation
box, shown side by side;
FIG. 9 is a bottom view thereof;
FIG. 10 is a right side view thereof;
FIG. 11 is a left side view thereof; and,
FIG. 12 is a top, right, perspective view thereof.
The base and the lid are shown separately in an unassembled
condition in FIGS. 8–12 for clarity.

[56] **References Cited**

U.S. PATENT DOCUMENTS

- D. 234,775 4/1975 Blackburn et al. D14/122
- D. 340,643 10/1993 Hirsch D9/418
- D. 355,359 2/1995 Herzog D9/422
- D. 373,725 9/1996 Weil D9/422
- 3,217,867 11/1965 Harris 206/468
- 3,530,978 9/1970 Lewandowski 206/468
- 3,918,577 11/1975 Horzick 206/6.1 X
- 3,930,577 1/1976 Kortick 206/301 X

1 Claim, 7 Drawing Sheets

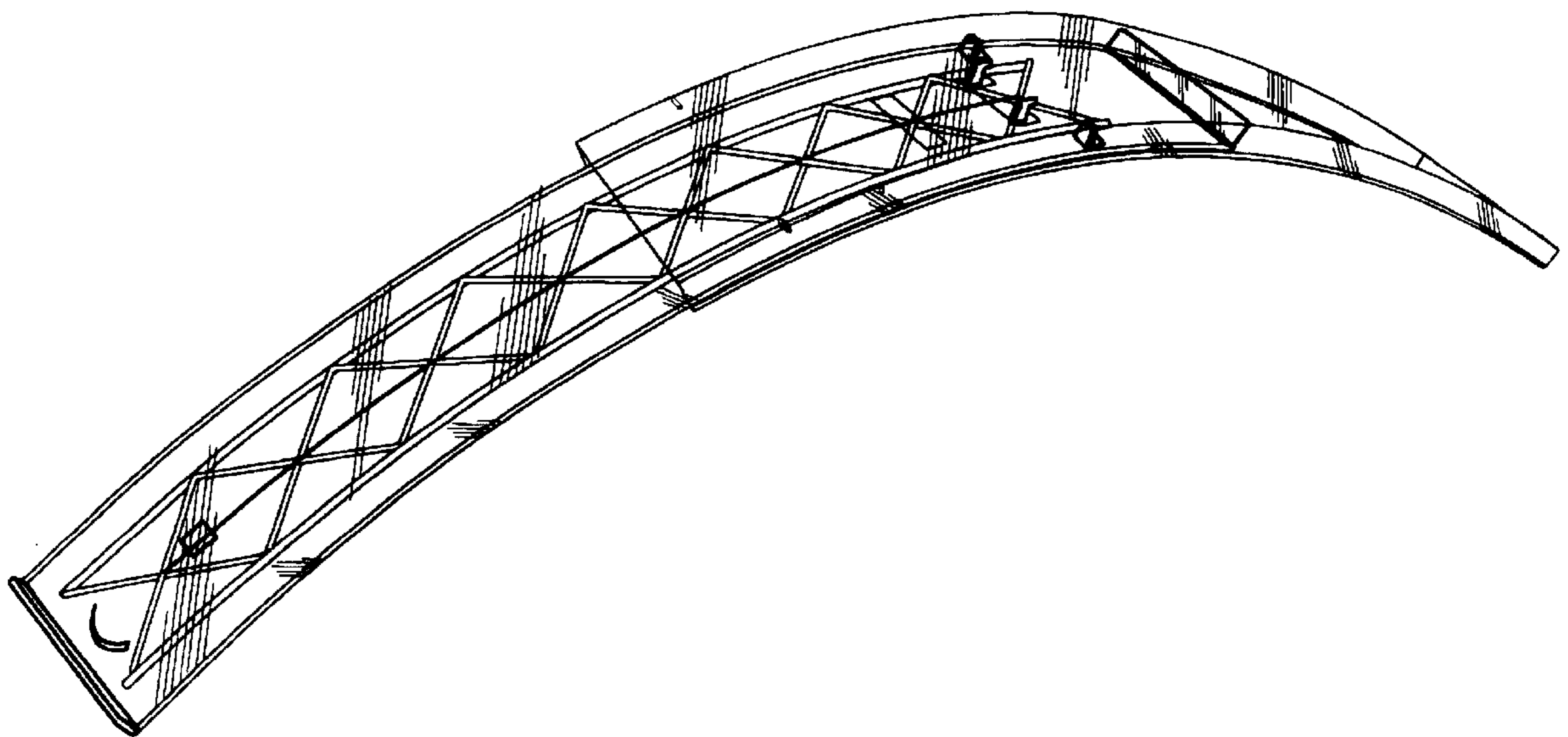

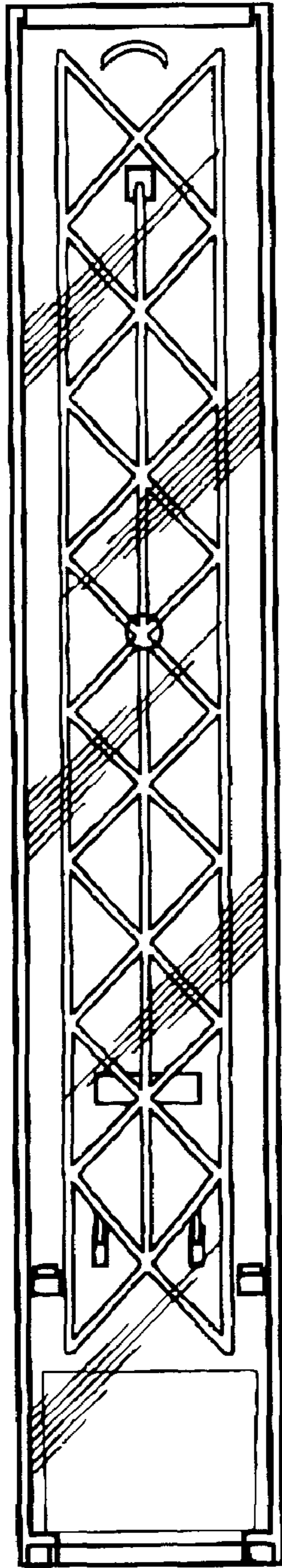

Fig. 1

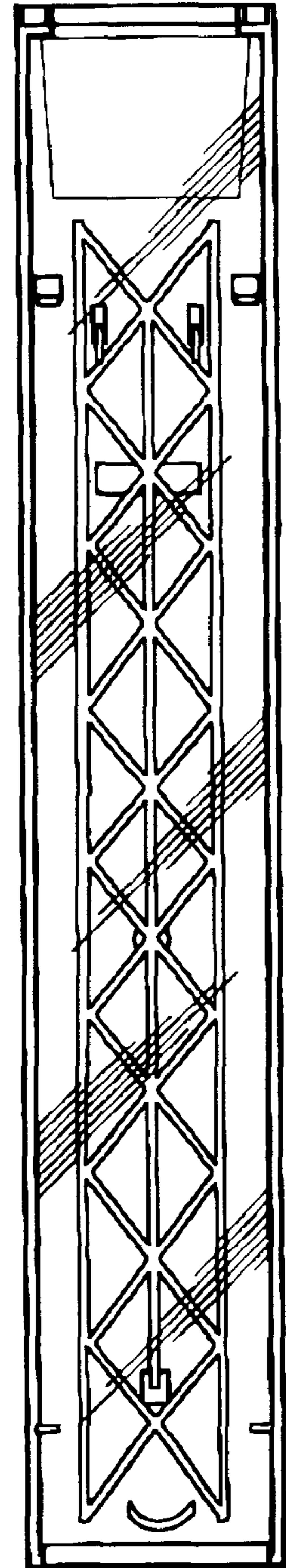

Fig. 2

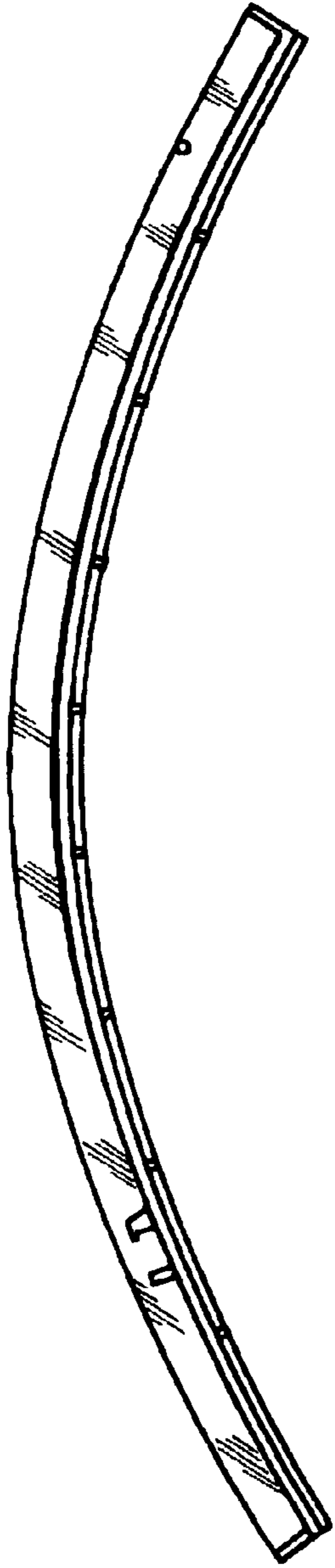

Fig. 3

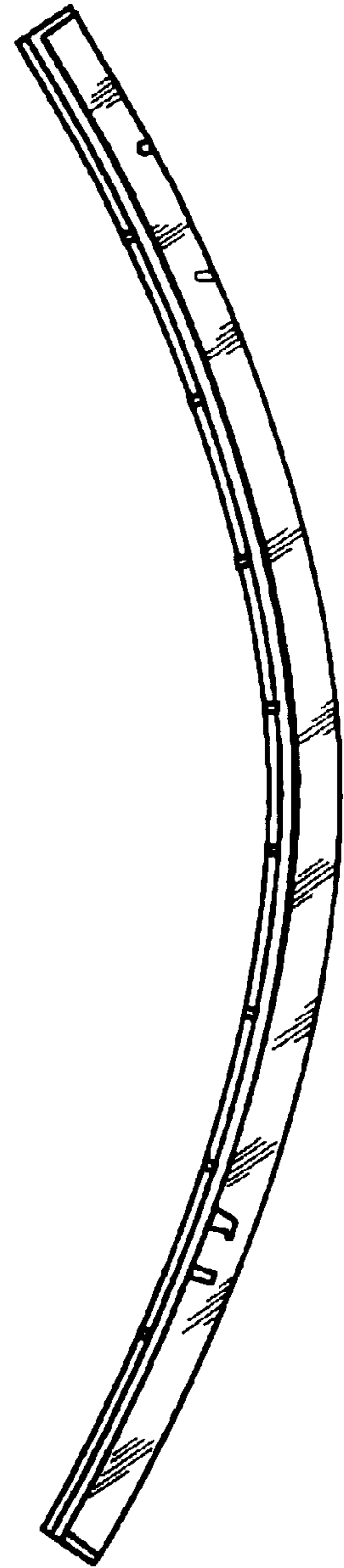

Fig. 4

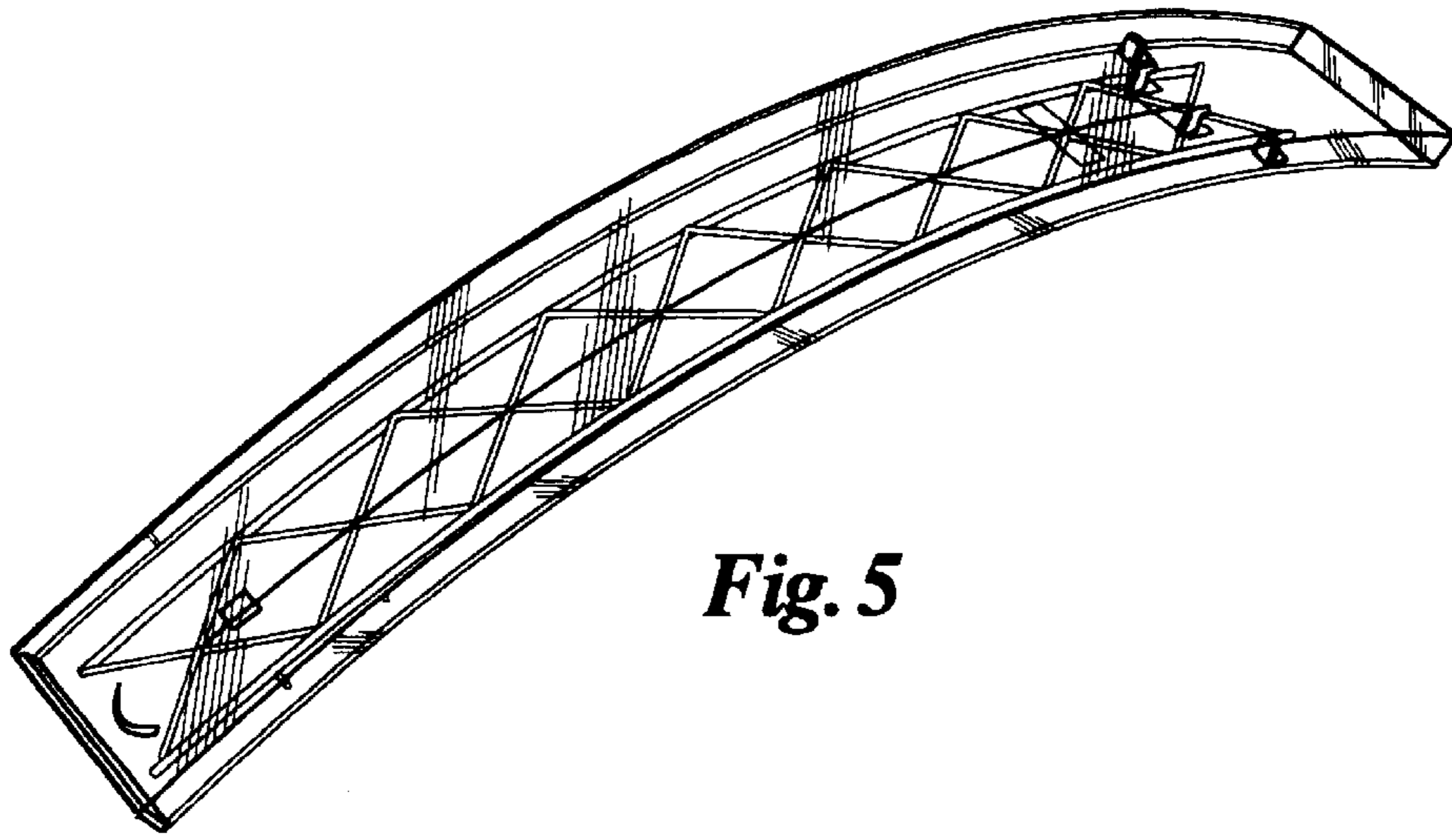

Fig. 5

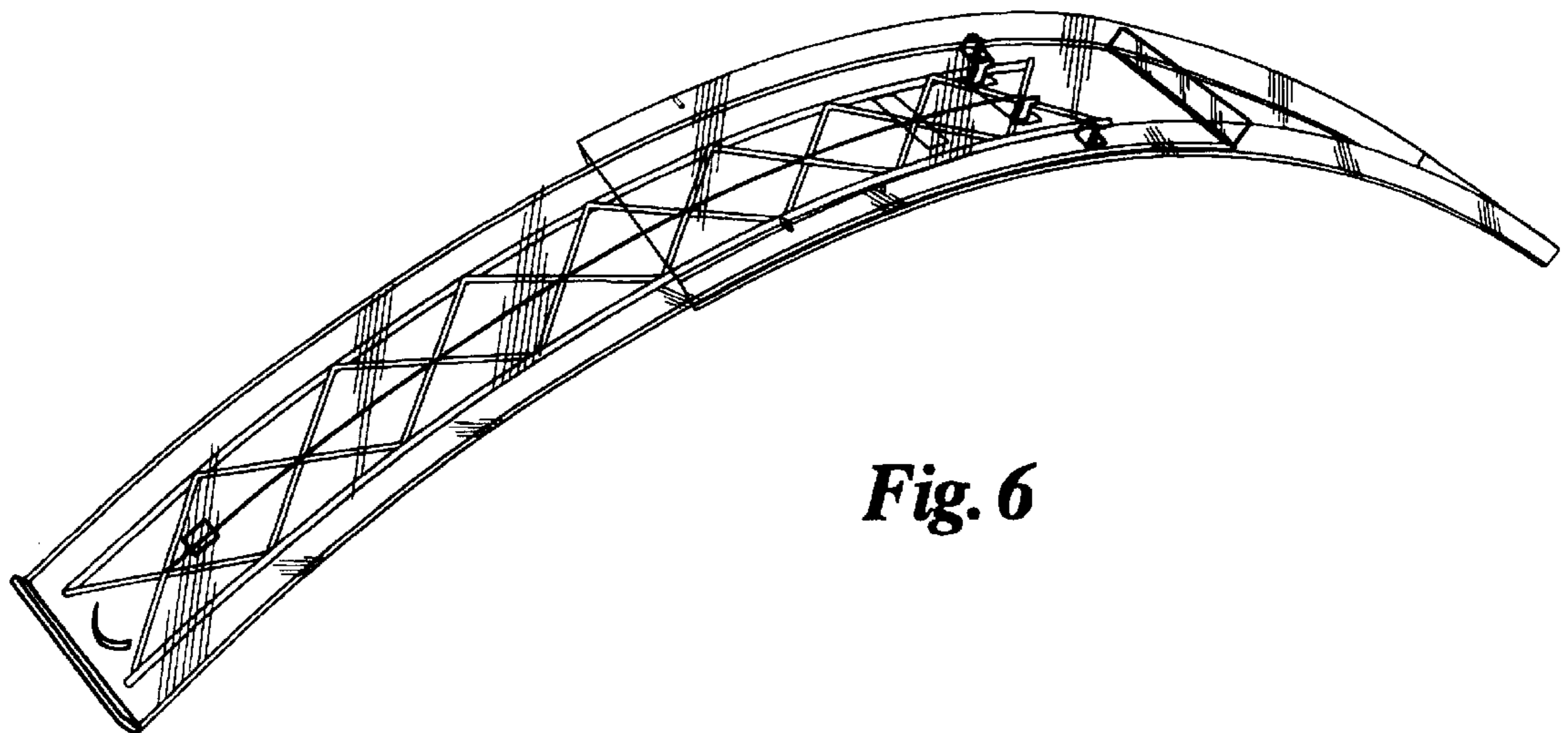

Fig. 6

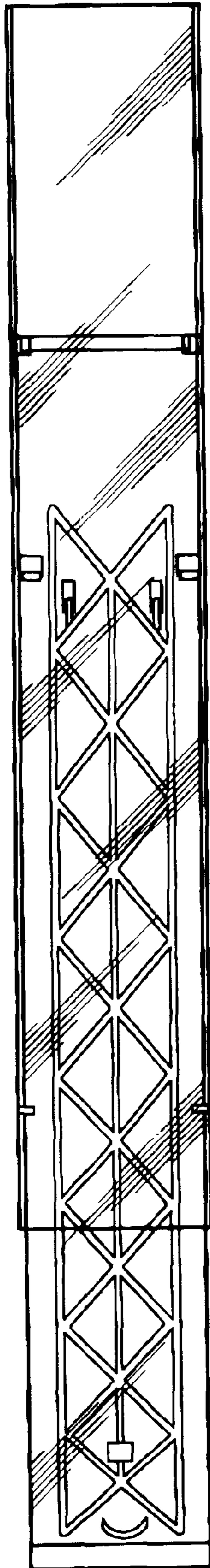

Fig. 7

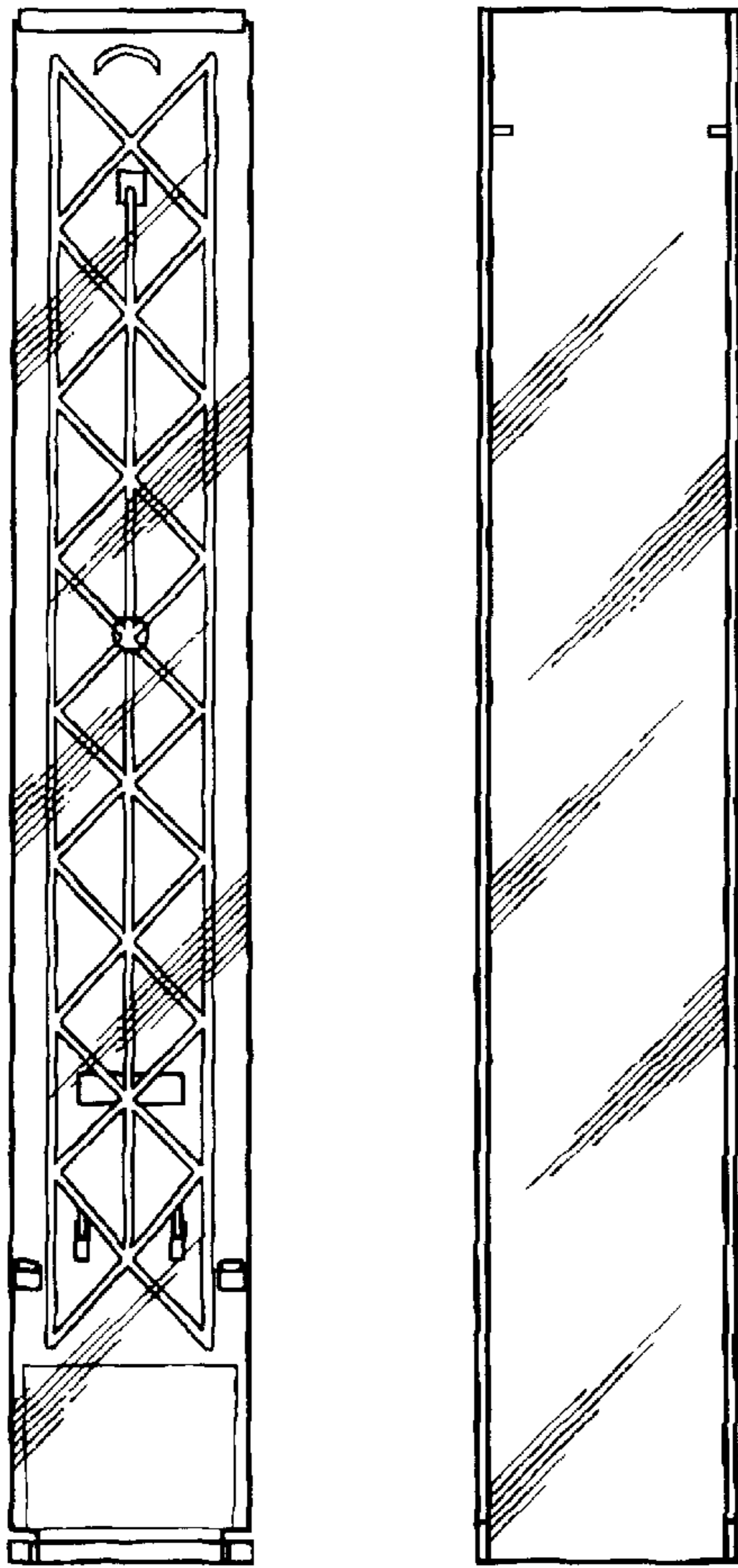

Fig. 8

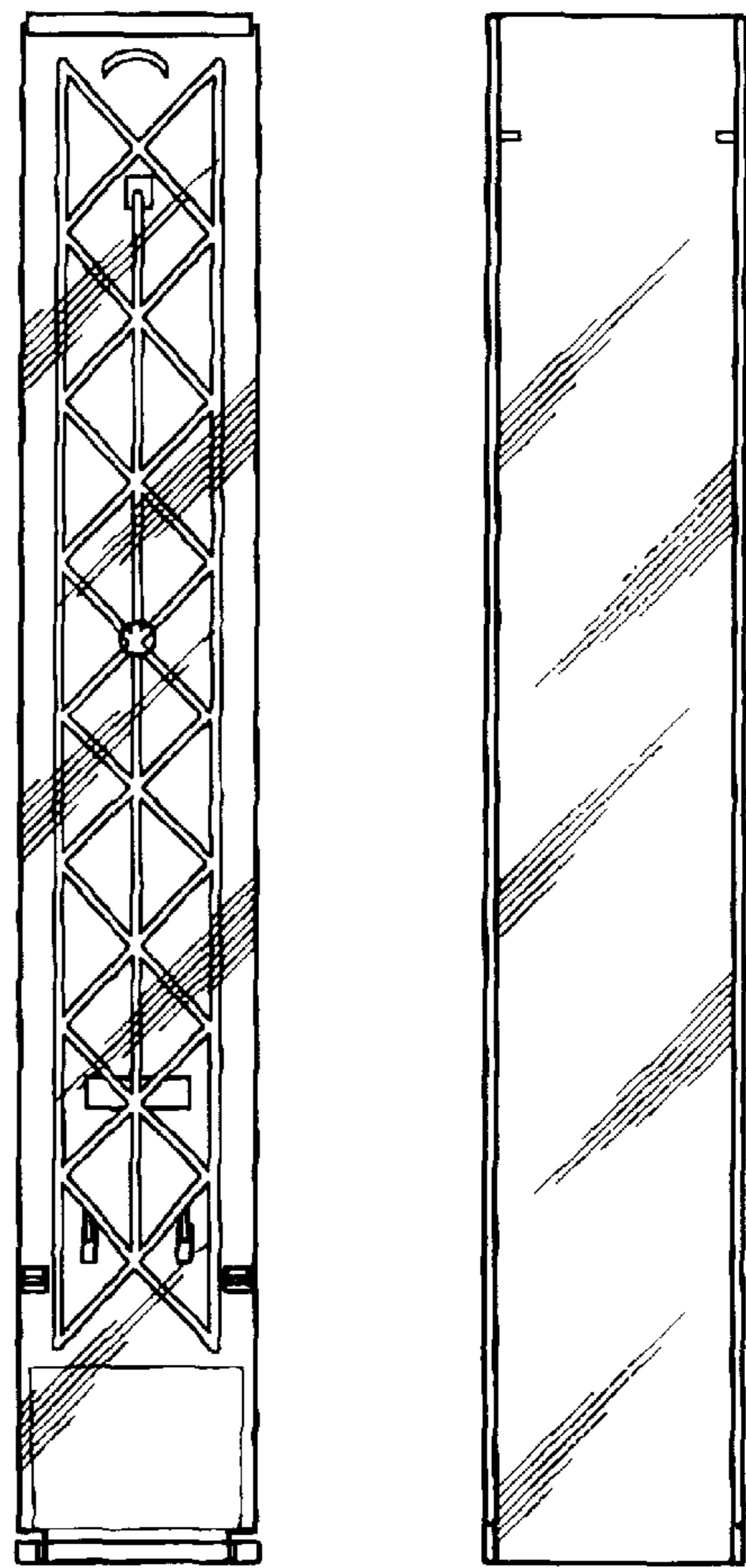

Fig. 9

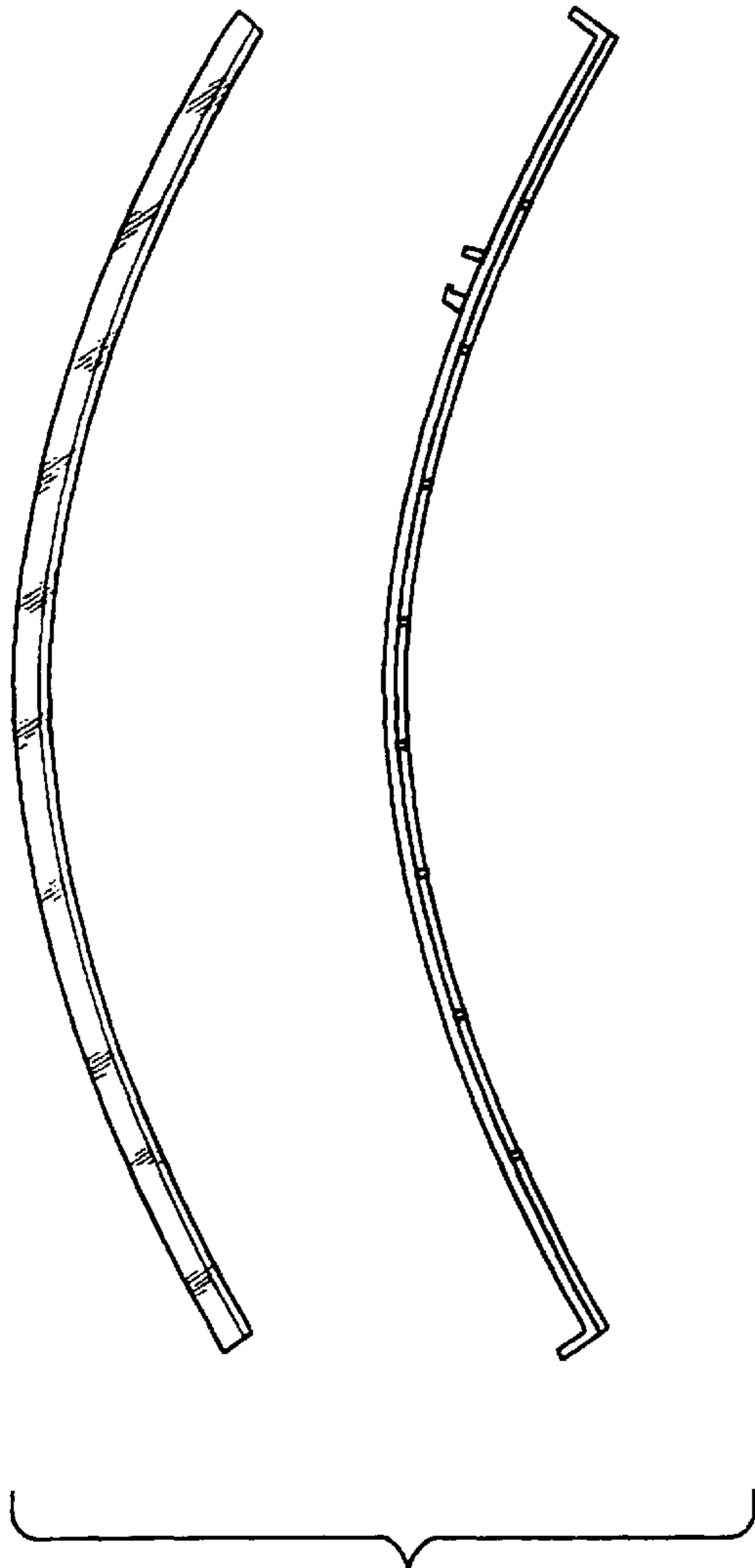

Fig. 10

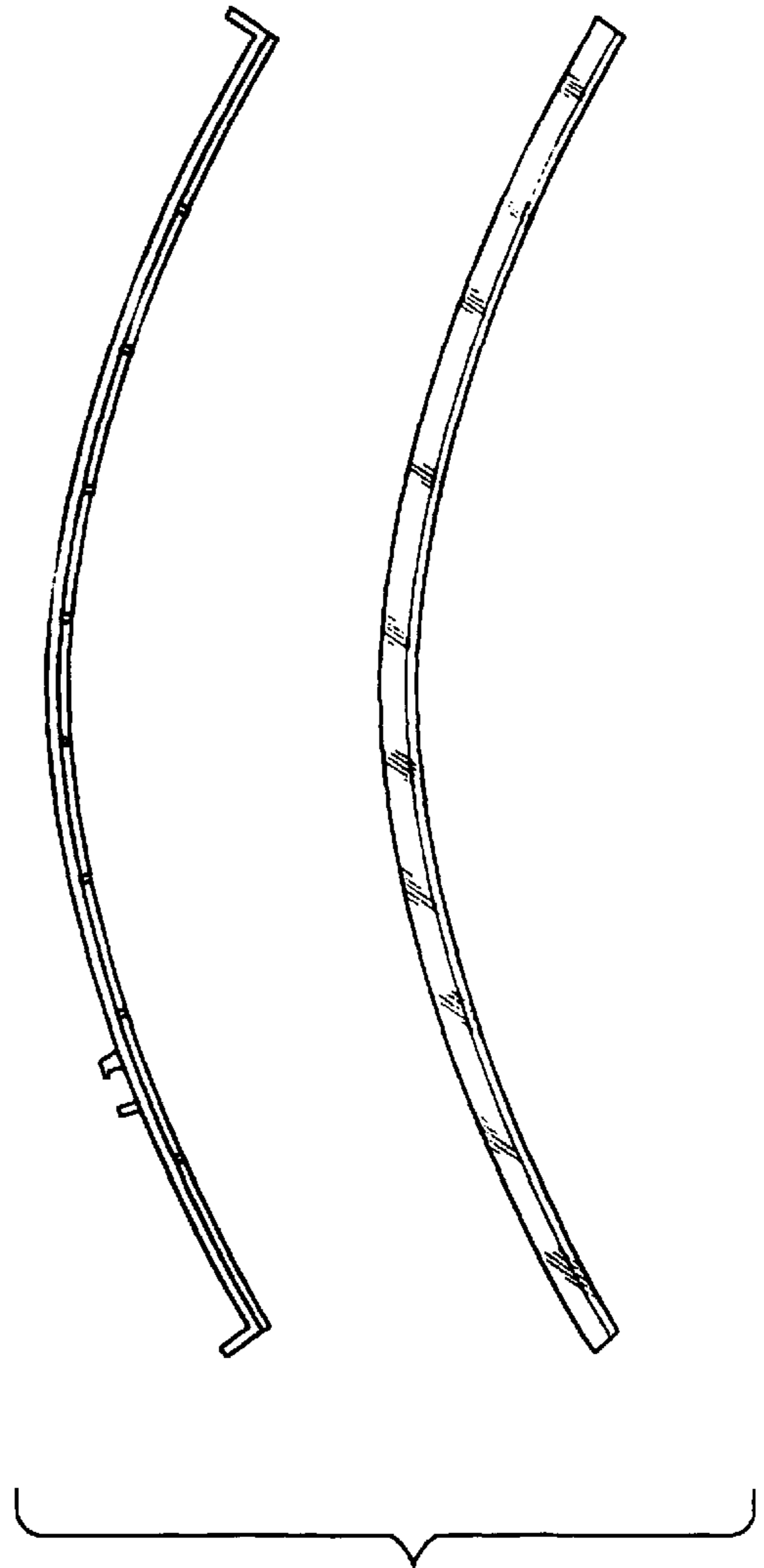
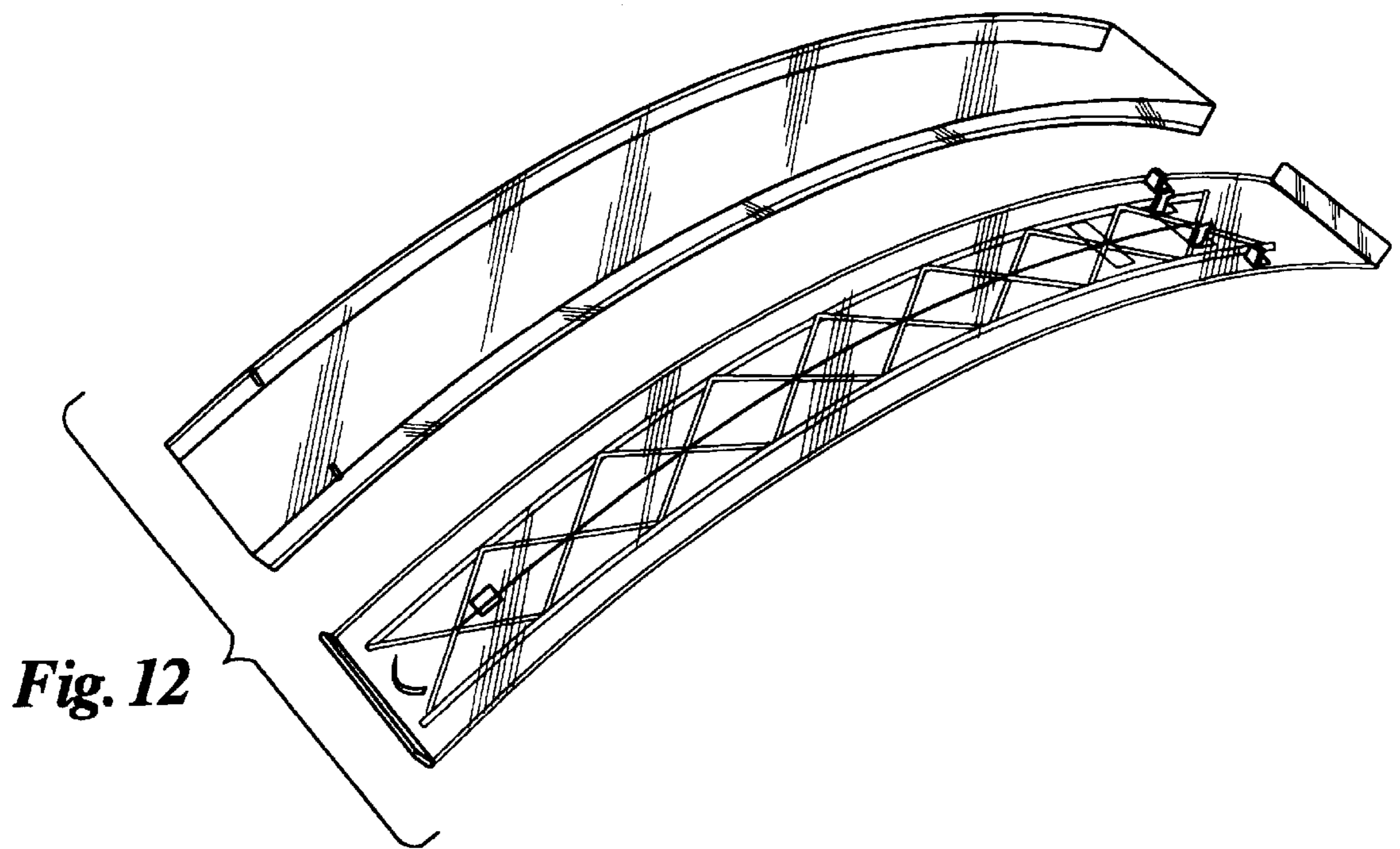

Fig. 11



UNITED STATES PATENT AND TRADEMARK OFFICE
CERTIFICATE OF CORRECTION

PATENT NO. : Des 431,777
DATED : October 10, 2000
INVENTOR(S) : Moshe Marciano

Page 1 of 1

It is certified that error appears in the above-identified patent and that said Letters Patent is hereby corrected as shown below:

Title page,

Below Item [76], Inventors, add in line Item [73]:

-- Swatch AG, Bienne, CH --

Signed and Sealed this

Twelfth Day of February, 2002

Attest:



Attesting Officer

JAMES E. ROGAN
Director of the United States Patent and Trademark Office