



US00D431634S

United States Patent [19] Mantz

[11] **Patent Number: Des. 431,634**

[45] **Date of Patent: ** Oct. 3, 2000**

[54] **ADAPTER TEE**

[76] Inventor: **Robert F. Mantz**, 2350 Woodlawn Cir.
East, St. Petersburg, Fla. 33704

[**] Term: **14 Years**

[21] Appl. No.: **29/110,830**

[22] Filed: **Sep. 13, 1999**

[51] **LOC (7) Cl. 23-01**

[52] **U.S. Cl. D23/263; D24/110**

[58] **Field of Search D23/263; D24/110,
D24/110.6; 285/132.1, 133.11; 128/204.18,
205.11**

[56] **References Cited**

U.S. PATENT DOCUMENTS

D. 294,175	2/1988	Briggs	D24/110
D. 331,281	11/1992	Levine	D24/110
D. 383,838	9/1997	Solano	D24/110
4,836,580	6/1989	Farrell	285/133.11
4,919,462	4/1990	Matsui et al.	285/133.11
5,027,809	7/1991	Robinson	128/204.18
5,425,358	6/1995	McGrail et al.	128/204.18
5,611,332	3/1997	Bono	128/204.18
5,853,002	12/1998	Kawasaki	128/204.18

OTHER PUBLICATIONS

Article entitled "Up-Draft II Neb-U-Mist Nebulizer", Hudson, 1987.

Article entitled "One-Way Valves & Accessories", Hudson, 1987.

Article entitled "Disposable Adaptors & Connectors", Hudson, 1987.

Primary Examiner—Alan P. Douglas

Assistant Examiner—Reid Hecker

[57] **CLAIM**

The ornamental designs for an adapter tee, as shown and described.

DESCRIPTION

FIG. 1 is a perspective view of my new design for an adapter tee;

FIG. 2 is a top elevation view thereof;

FIG. 3 is a front elevation view thereof;

FIG. 4 is a bottom elevation view thereof;

FIG. 5 is a rear elevation view thereof;

FIG. 6 is a left side elevation view thereof; and,

FIG. 7 is a right side elevation view thereof.

1 Claim, 1 Drawing Sheet

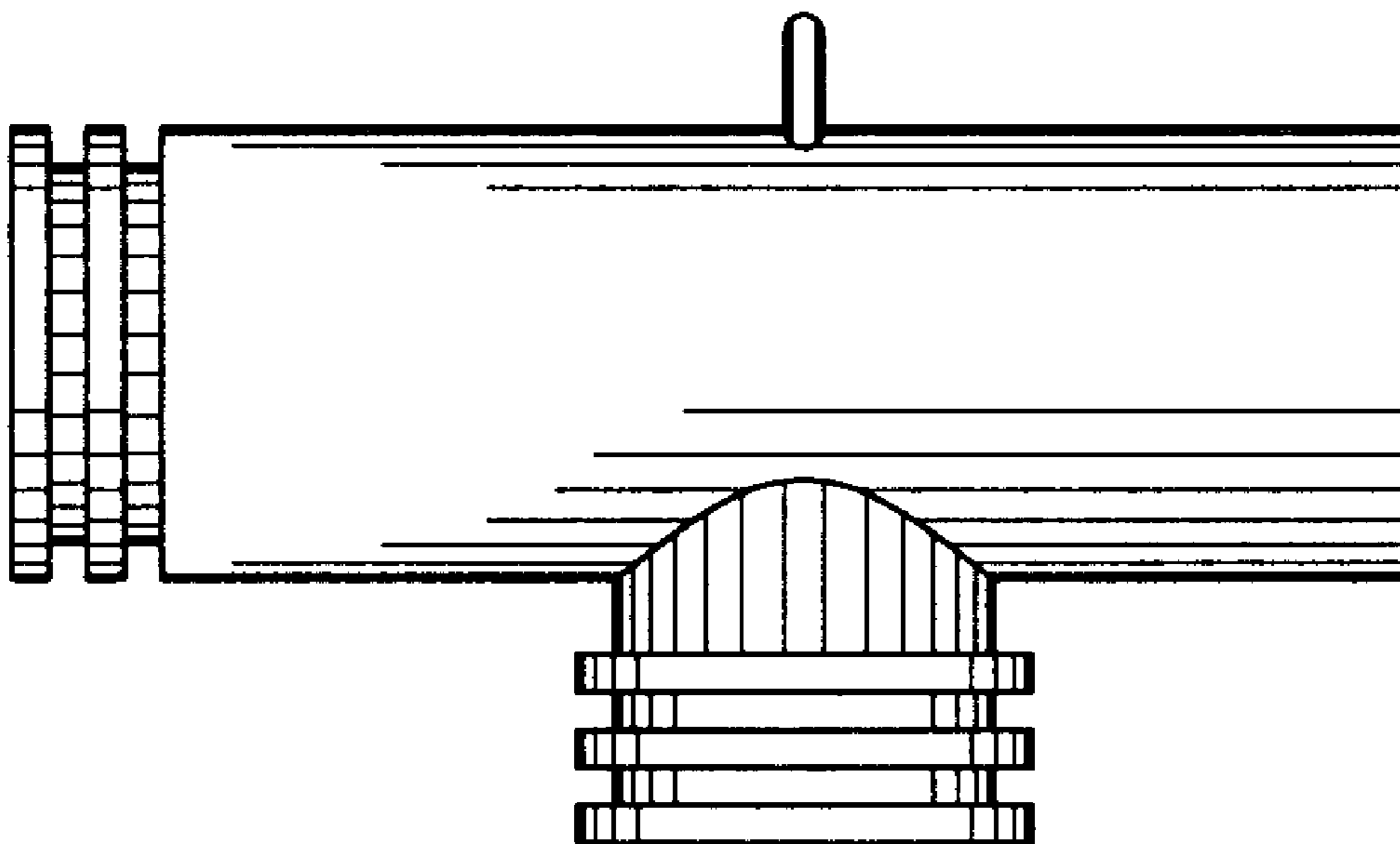

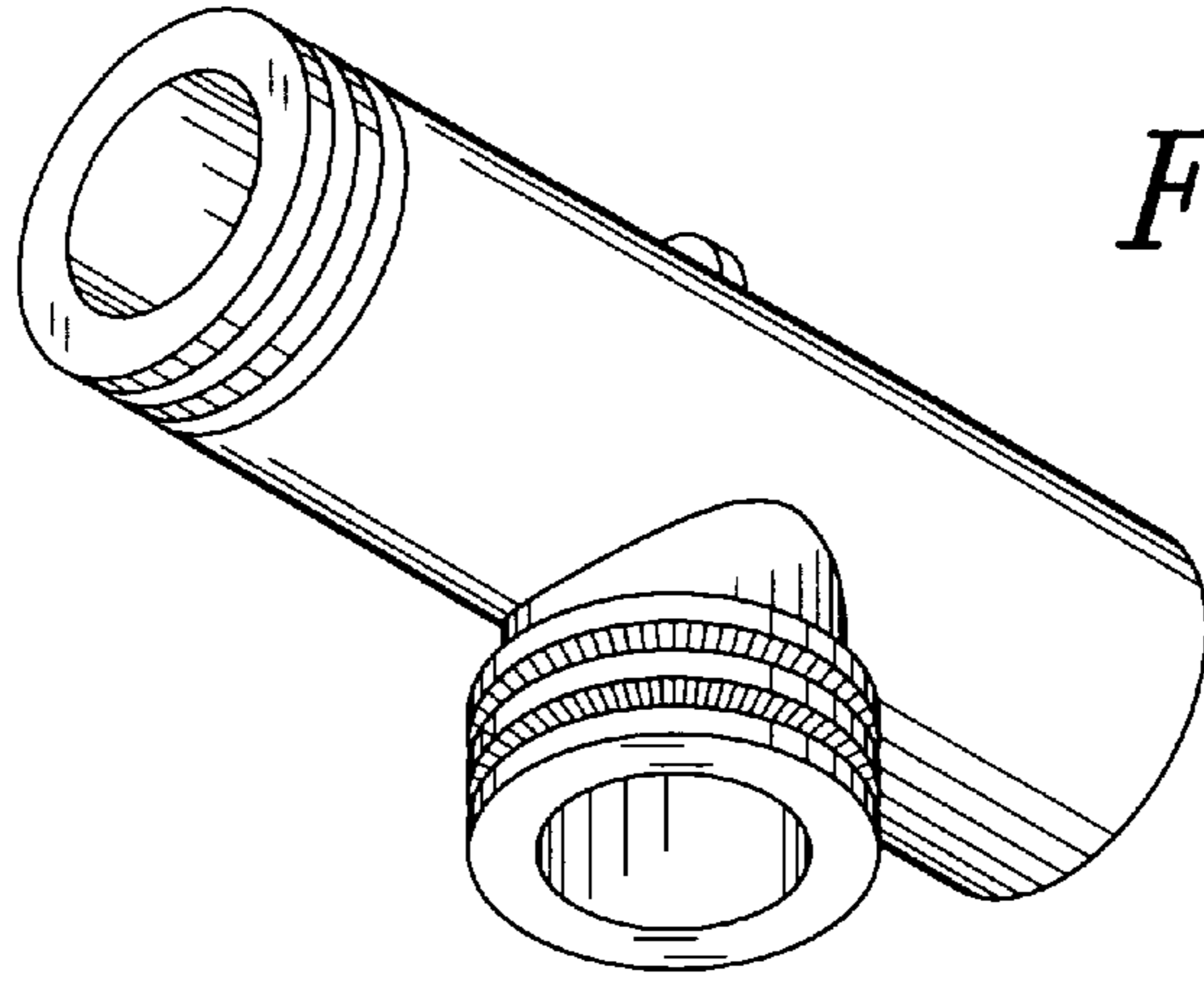

FIG. 1

FIG. 2

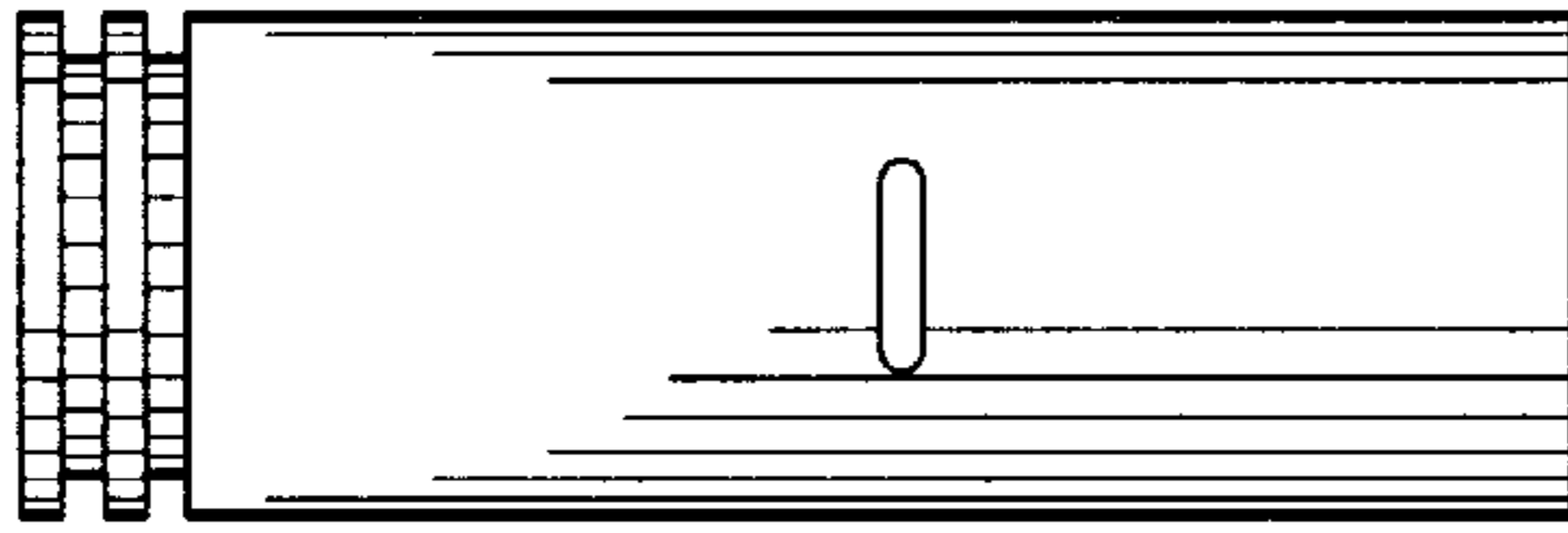

FIG. 3

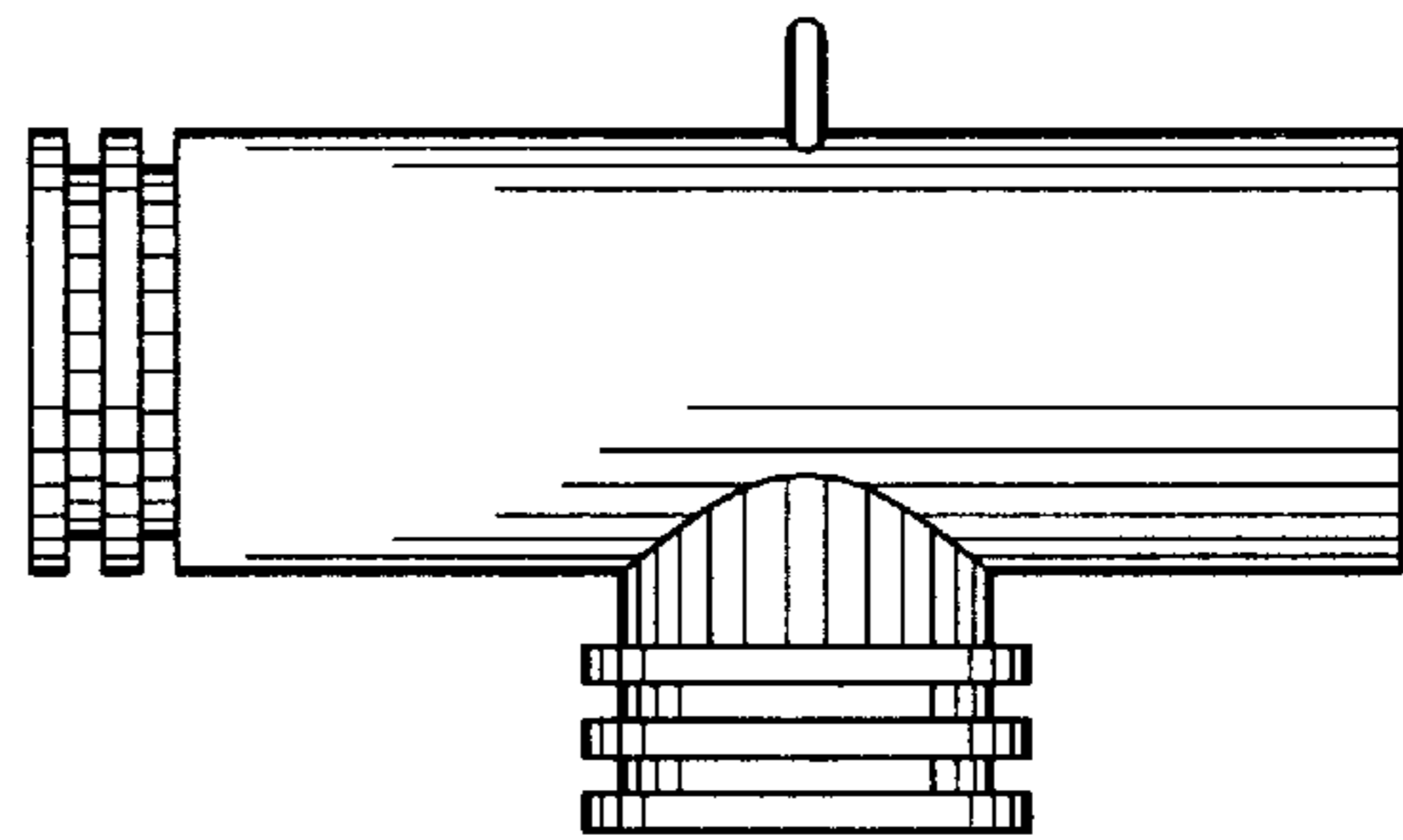

FIG. 4

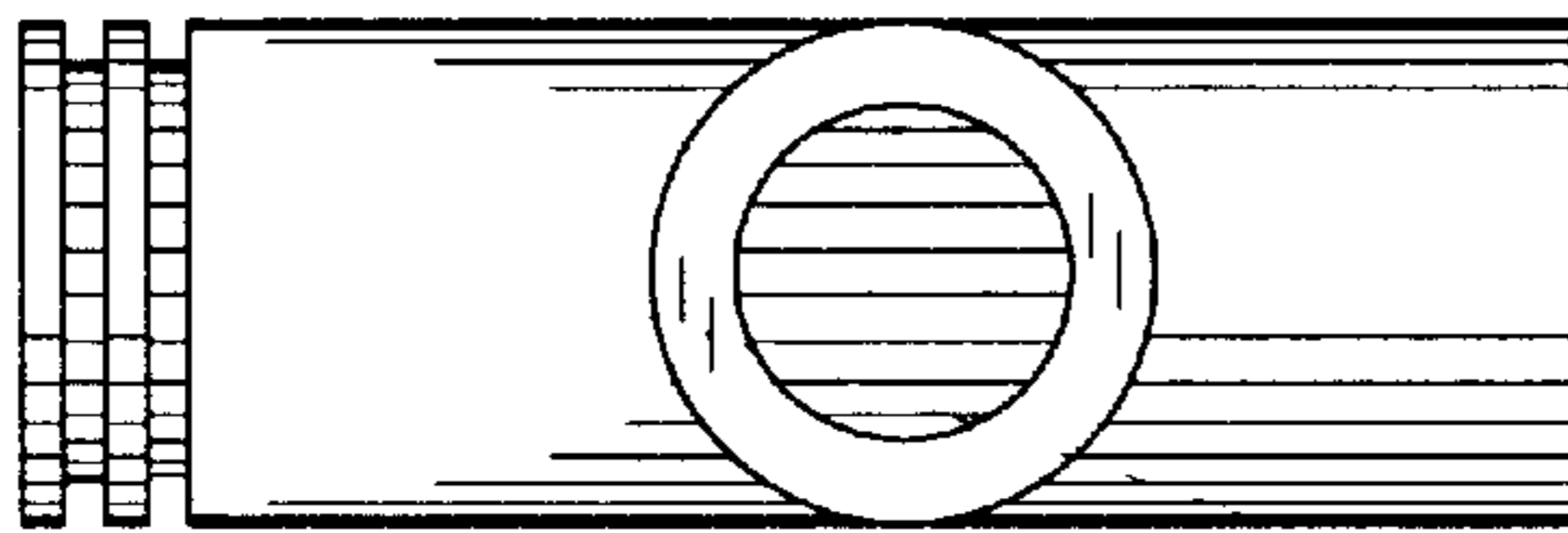

FIG. 5

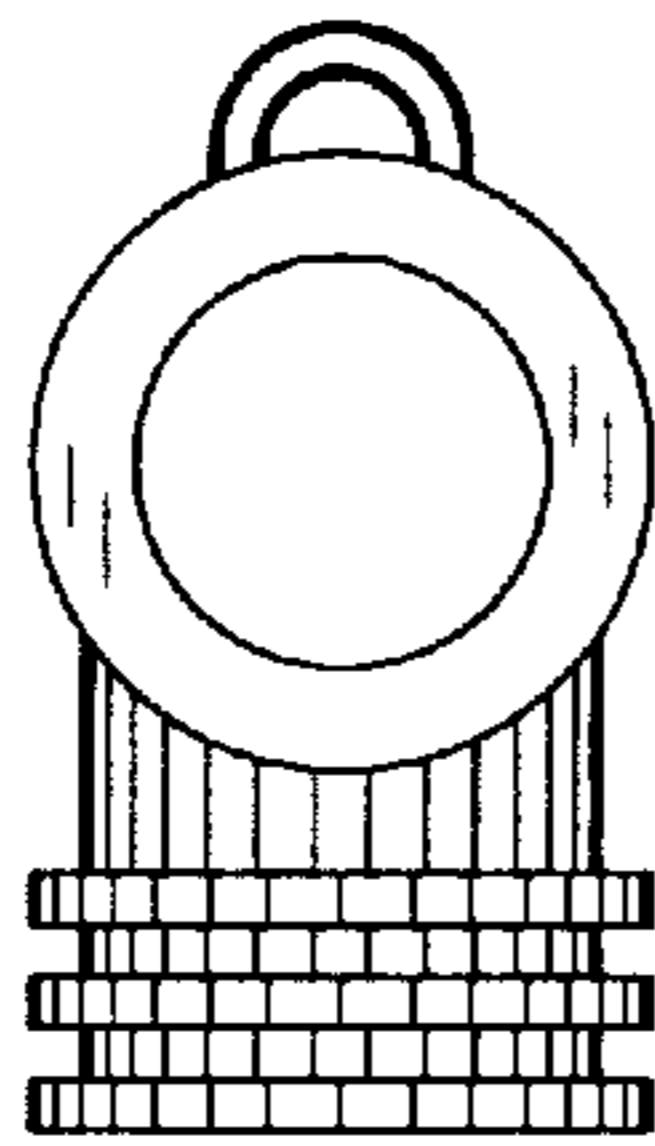
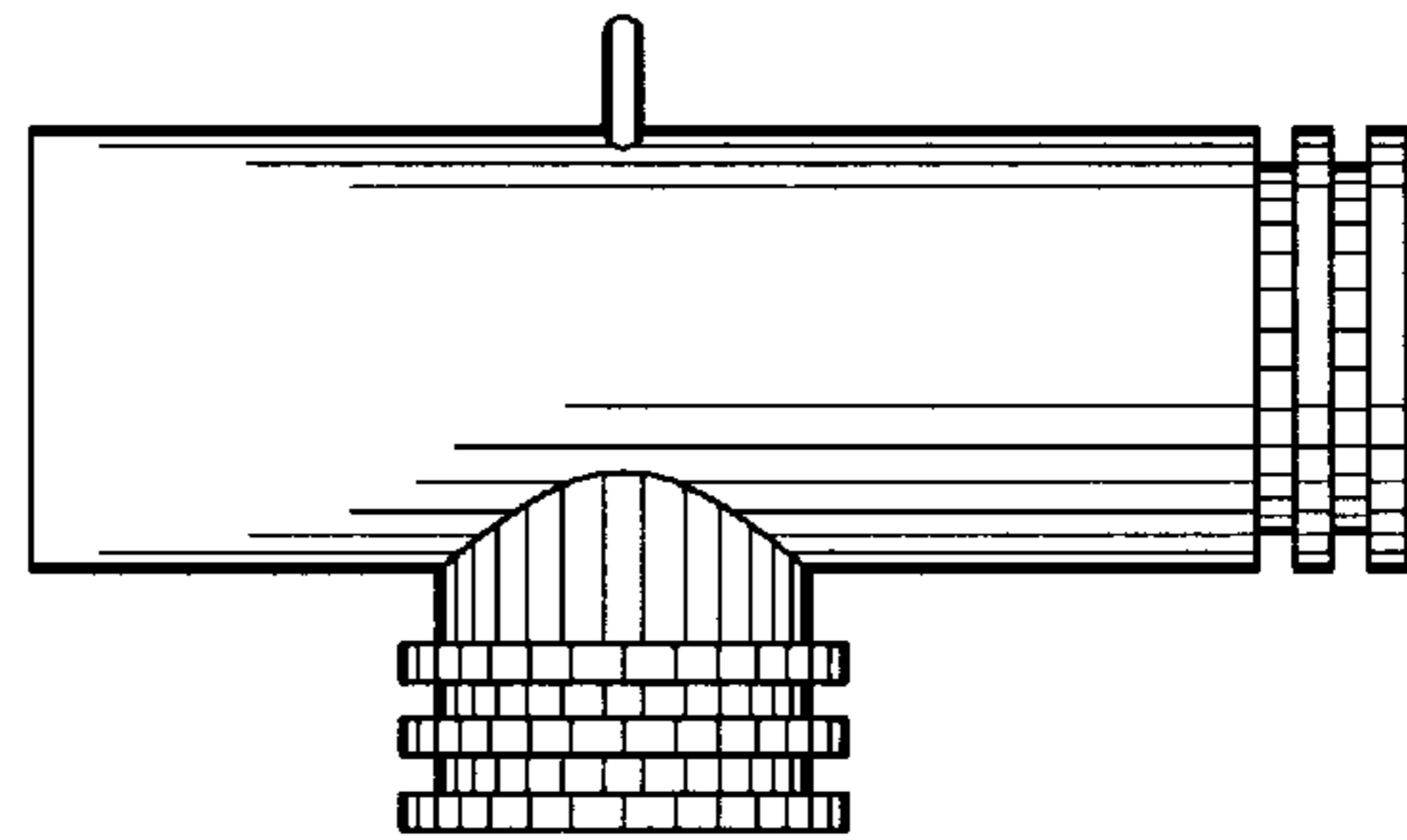

FIG. 6

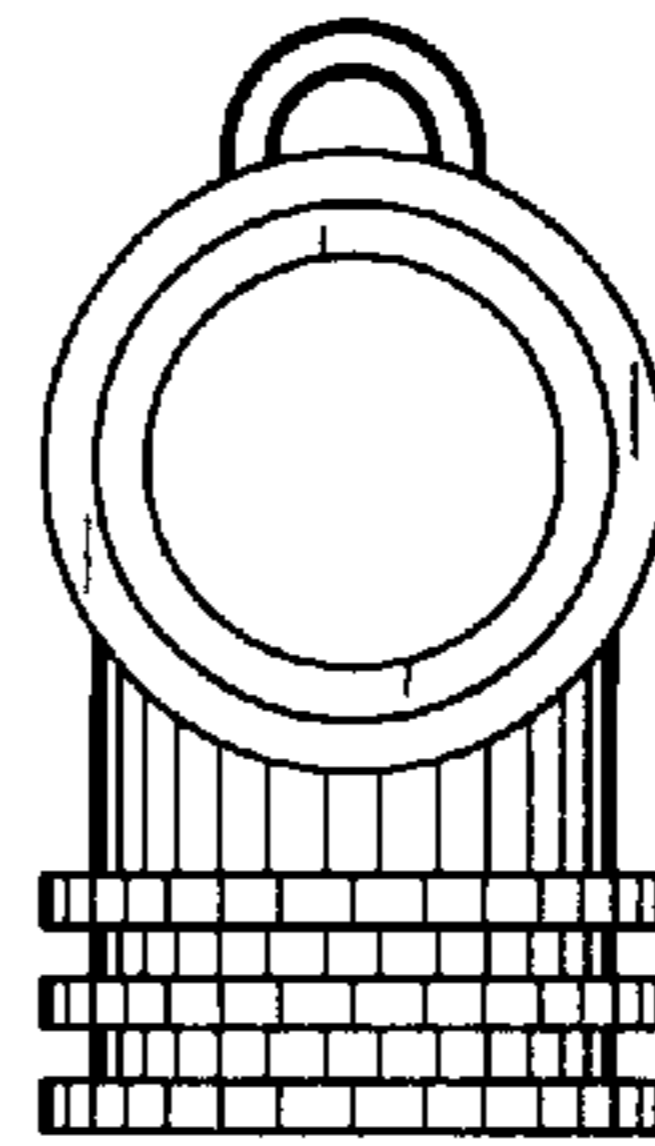

FIG. 7