



US00D431601S

United States Patent [19]

Koehneke et al.

[11] Patent Number: Des. 431,601

[45] Date of Patent: ** Oct. 3, 2000

[54] CARD TRAY

3,589,523 6/1971 Belden 211/51

[75] Inventors: **Mark S. Koehneke**, Milwaukee; **David C. Harris**, Baraboo; **Richard S. Walters**, Port Washington, all of Wis.

Primary Examiner—Martie K. Holtje
Attorney, Agent, or Firm—Foley & Lardner

[73] Assignee: **Newell Office Products, Inc.**, Madison, Wis.

[57] **CLAIM**

I claim the ornamental design for the card tray, as shown and described.

[**] Term: **14 Years**

DESCRIPTION

[21] Appl. No.: **29/095,970**

FIG. 1 is a perspective view of a card tray; FIG. 2 is a right side view of the card tray shown in FIG. 1; FIG. 3 is a top view of the card tray shown in FIG. 1; FIG. 4 is a front view of the card tray shown in FIG. 1; FIG. 5 is a rear view of the card tray shown in FIG. 1; FIG. 6 is a perspective view of an alternative embodiment of the card tray shown in FIG. 1; FIG. 7 is a right side view of the card tray shown in FIG. 6; FIG. 8 is a top view of the card tray shown in FIG. 6; FIG. 9 is a front view of the card tray shown in FIG. 6; and, FIG. 10 is a rear view of the card tray shown in FIG. 6. The broken lines showing portions of the card tray and the lower perimeter of the side element in FIGS. 1–10 are for illustrative purposes only and form no part of the claimed design.

[22] Filed: **Nov. 2, 1998**

[51] **LOC (7) Cl.** **19-02**

[52] **U.S. Cl.** **D19/76; D19/99**

[58] **Field of Search** D19/65, 75, 76, D19/78, 86, 90, 91, 92, 95, 99, 100; 211/10, 11, 45, 50, 51, 55; 40/371–380; 312/183, 185, 189, 193; 206/425

[56] **References Cited**

U.S. PATENT DOCUMENTS

- D. 232,334 8/1974 Neilsen D19/76
- D. 266,336 9/1982 Leib, III D19/76
- D. 414,209 9/1999 Koehneke et al. D19/76

1 Claim, 6 Drawing Sheets

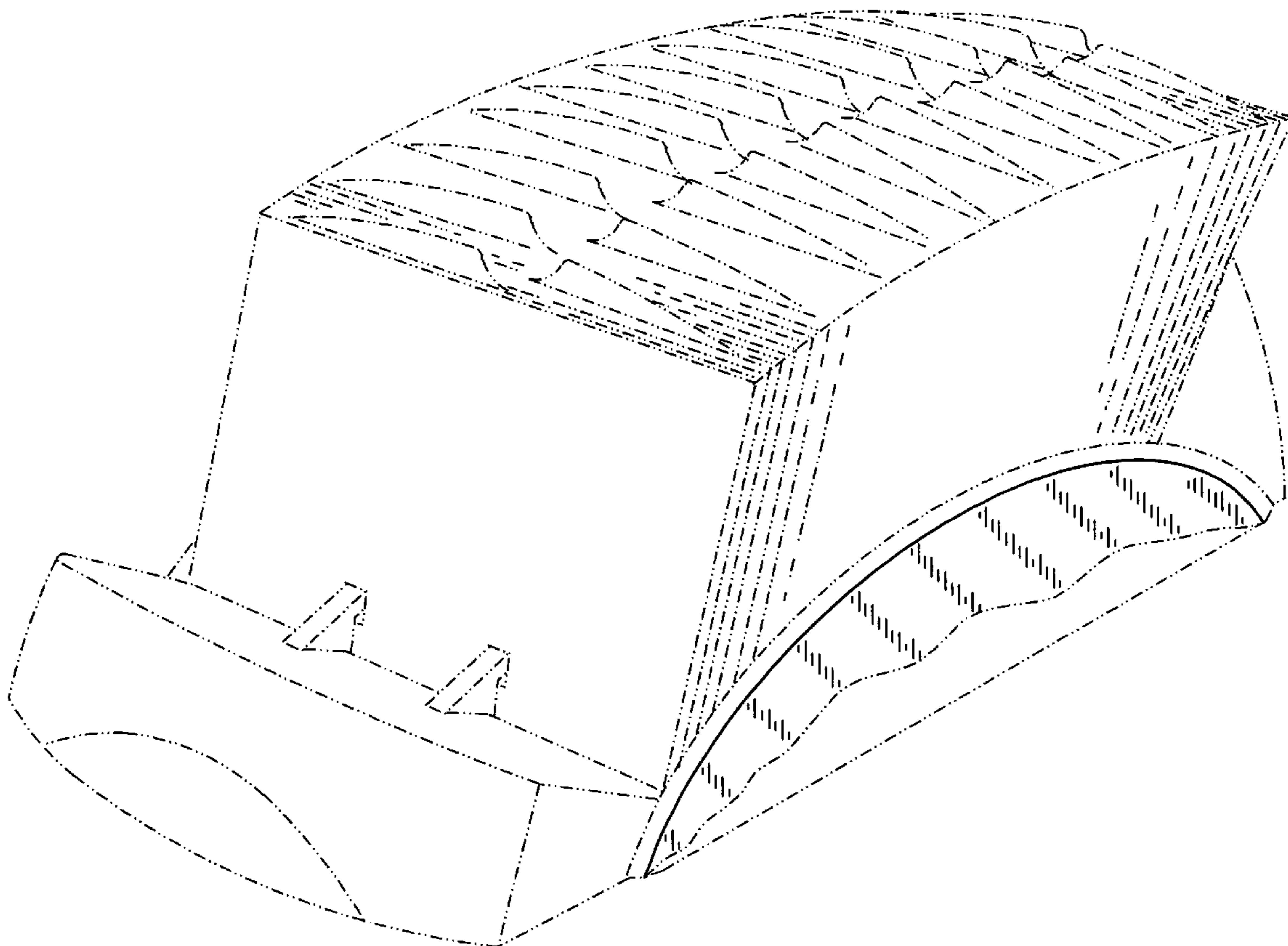

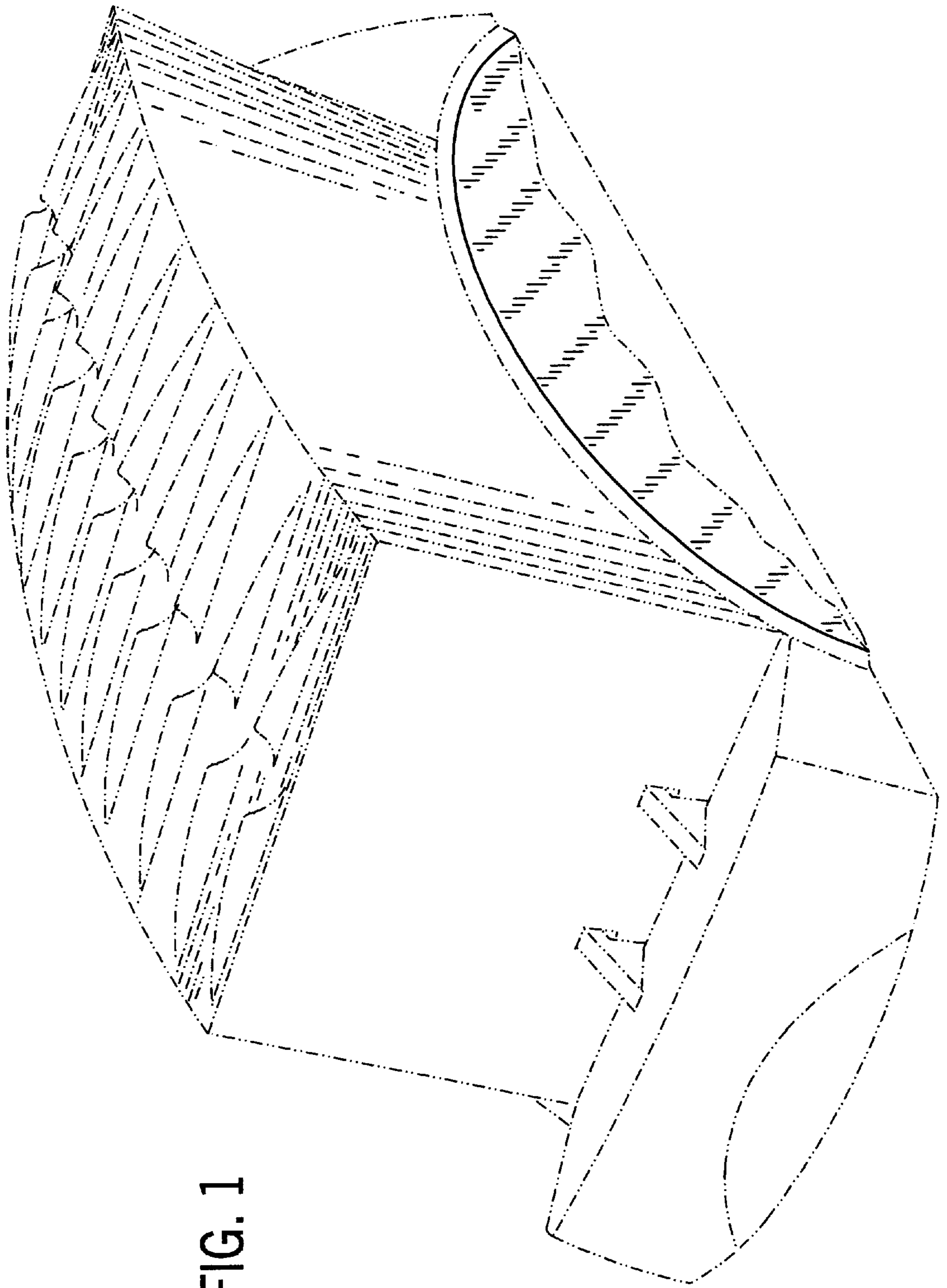

FIG. 1

FIG. 2

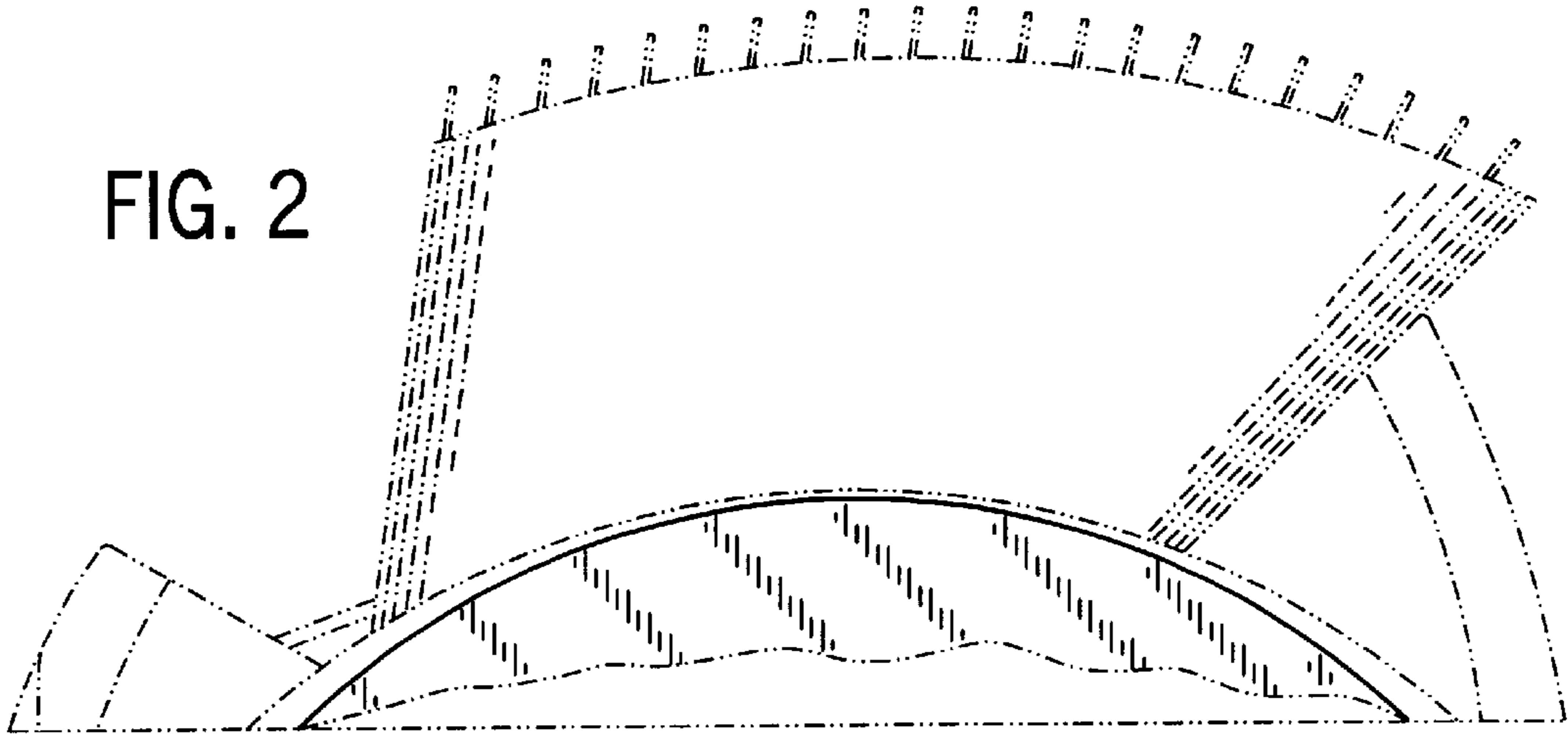

FIG. 3

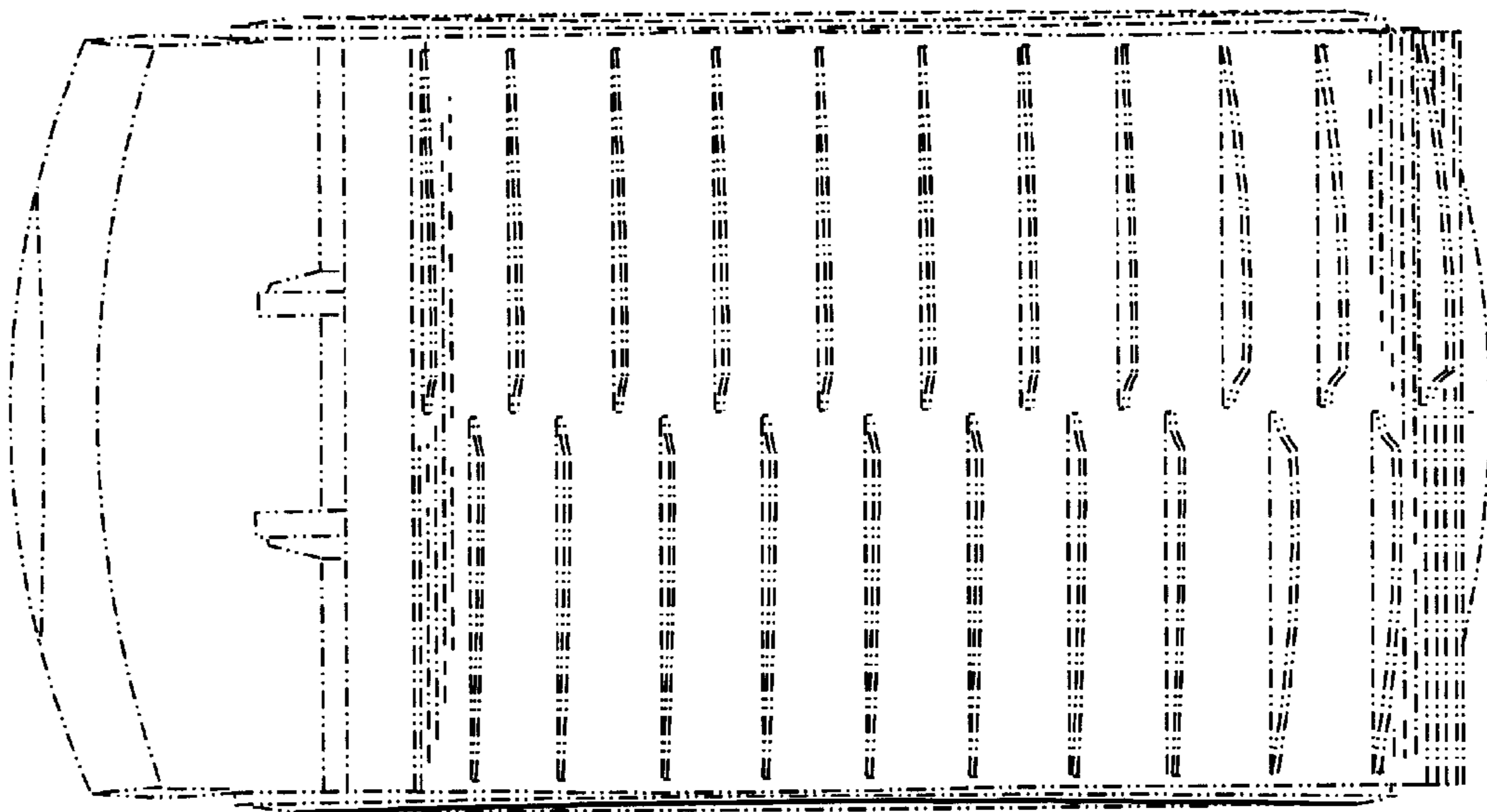

FIG. 4

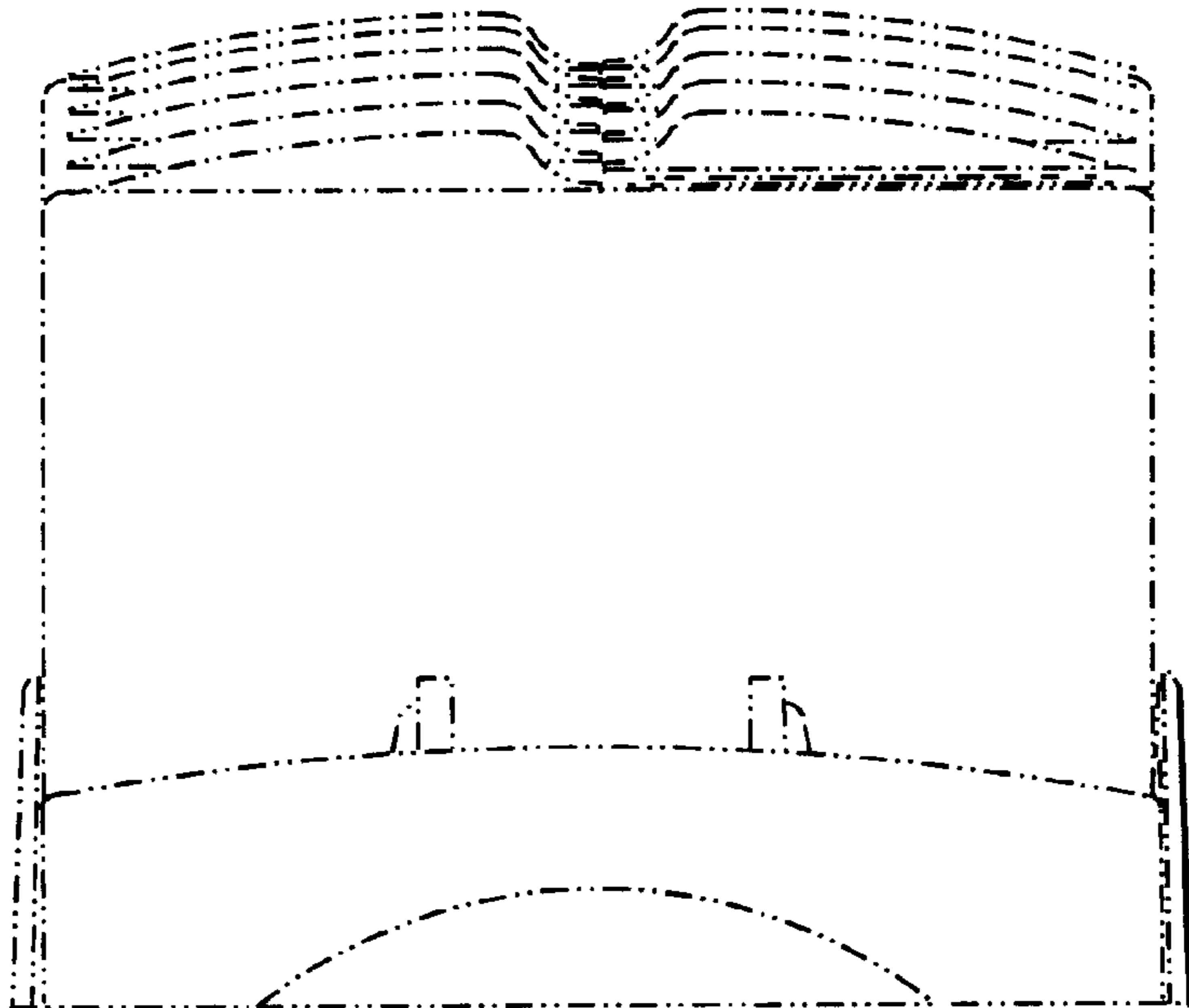
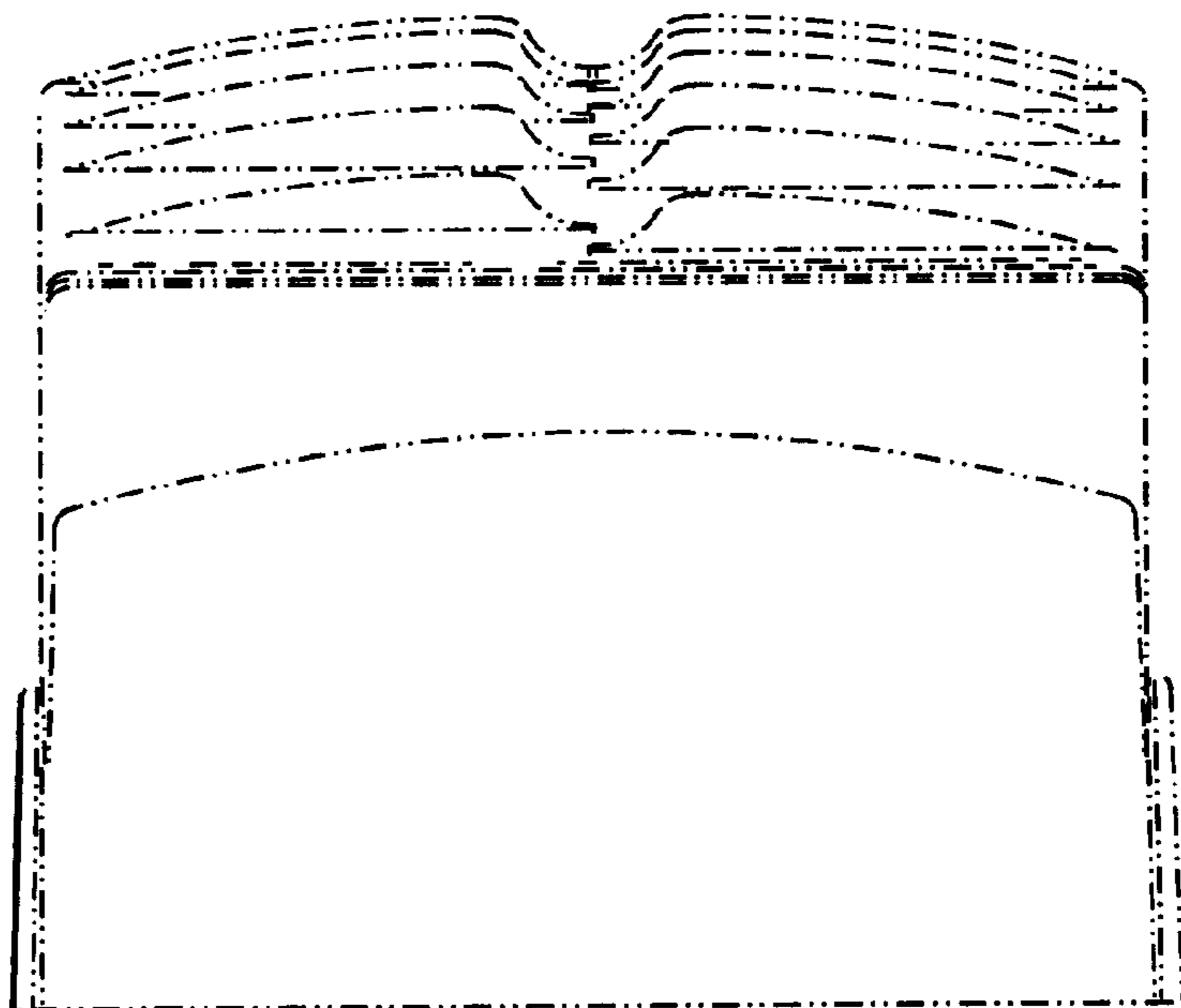

FIG. 5



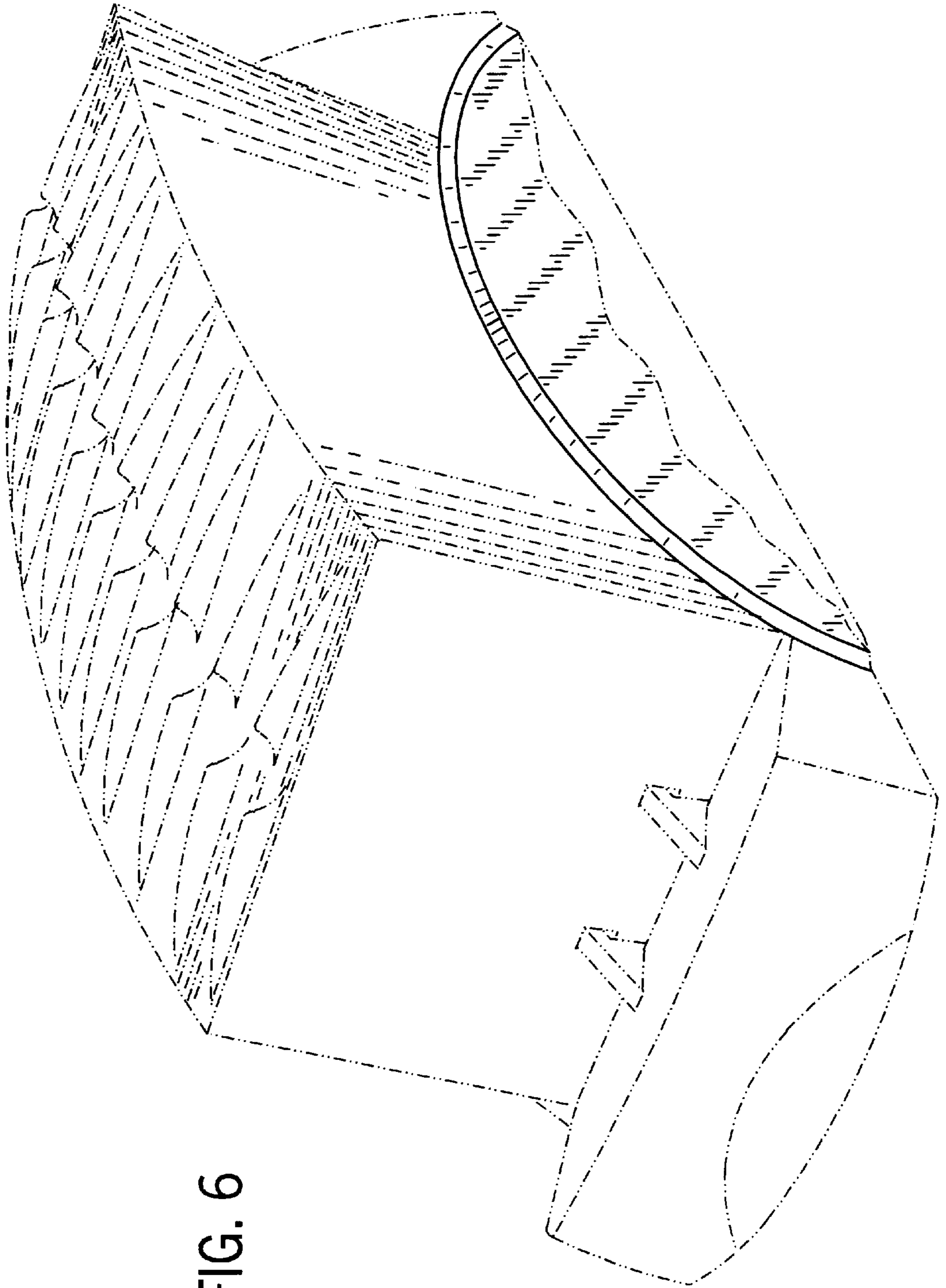

FIG. 6

FIG. 7

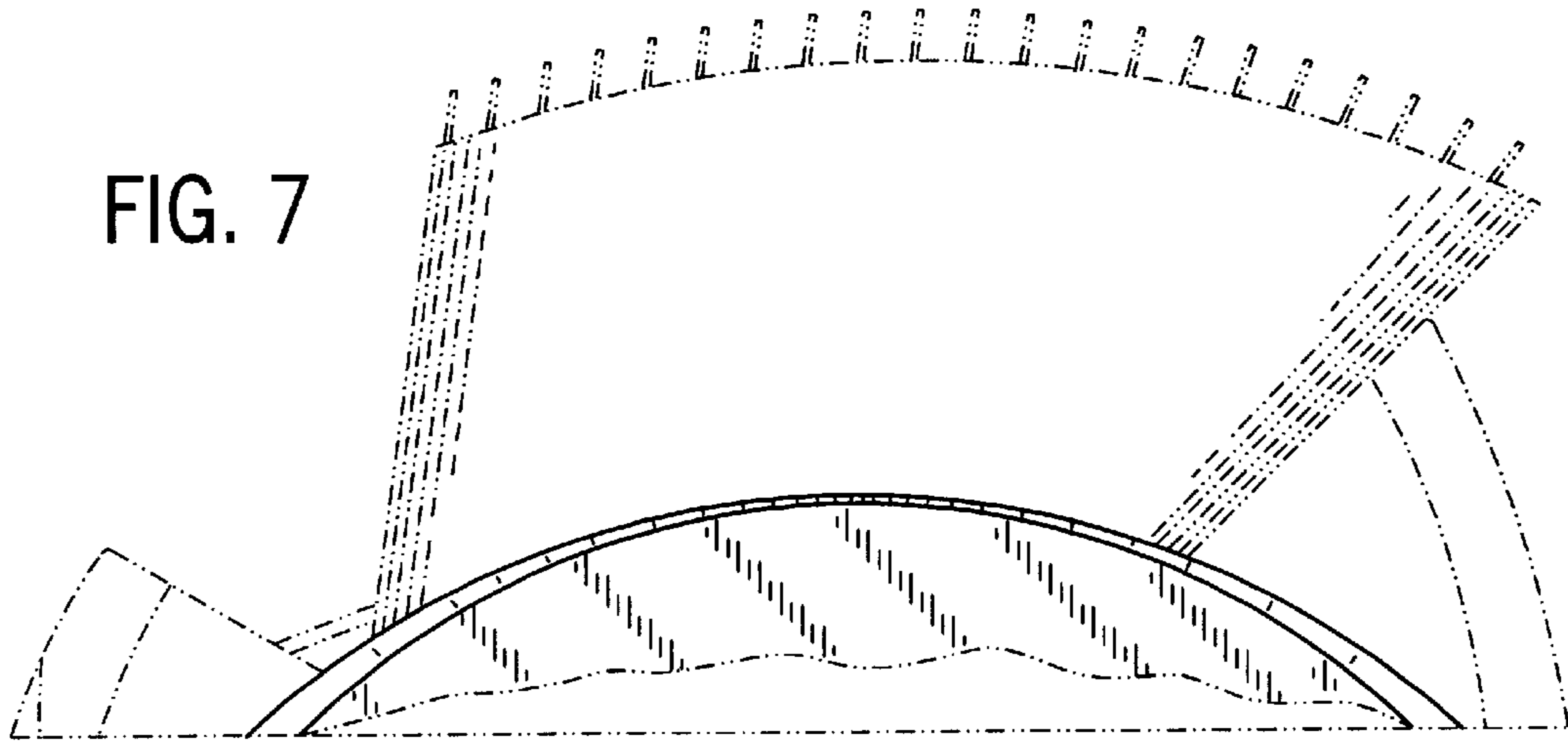

FIG. 8

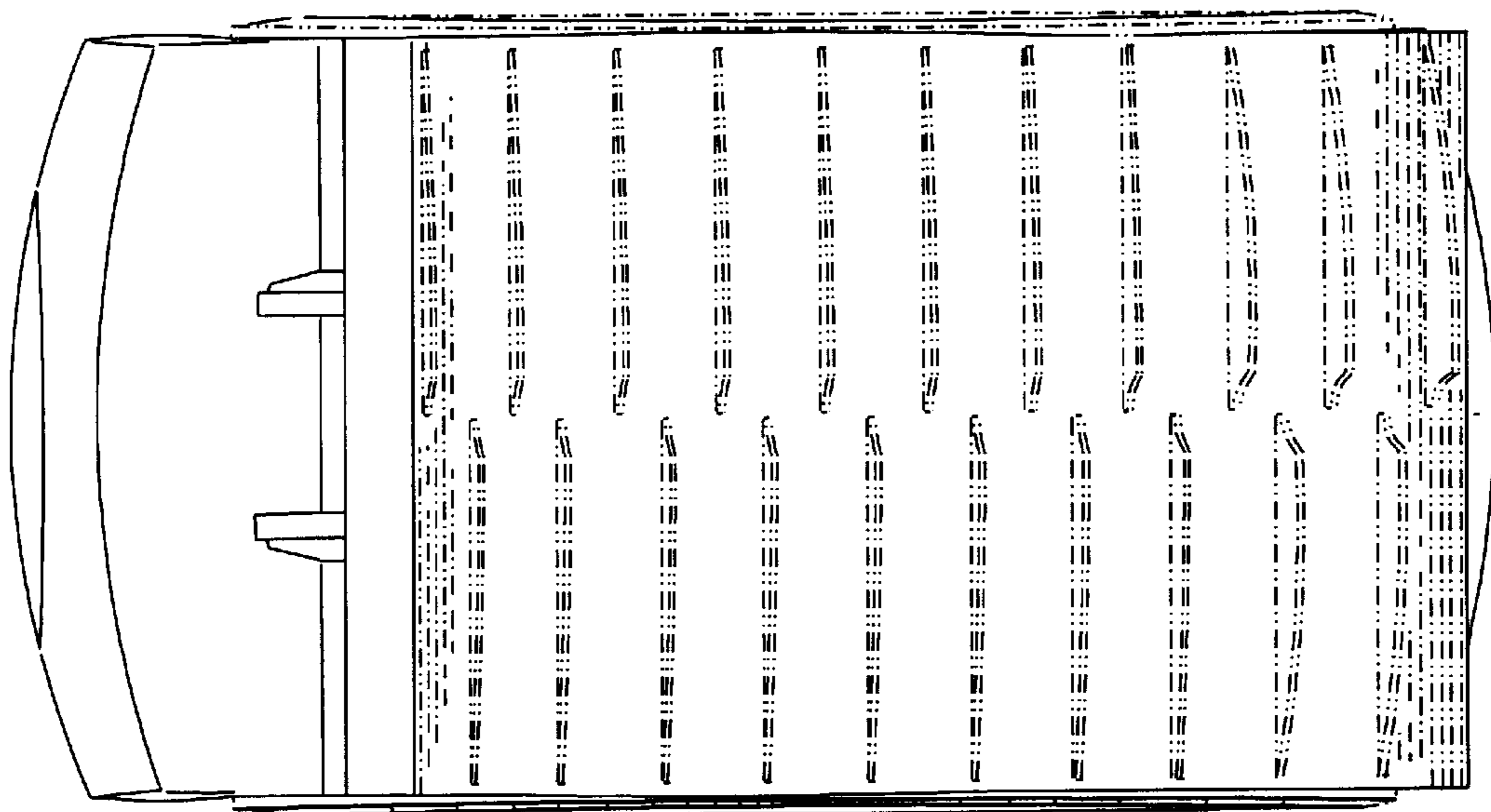

FIG. 9

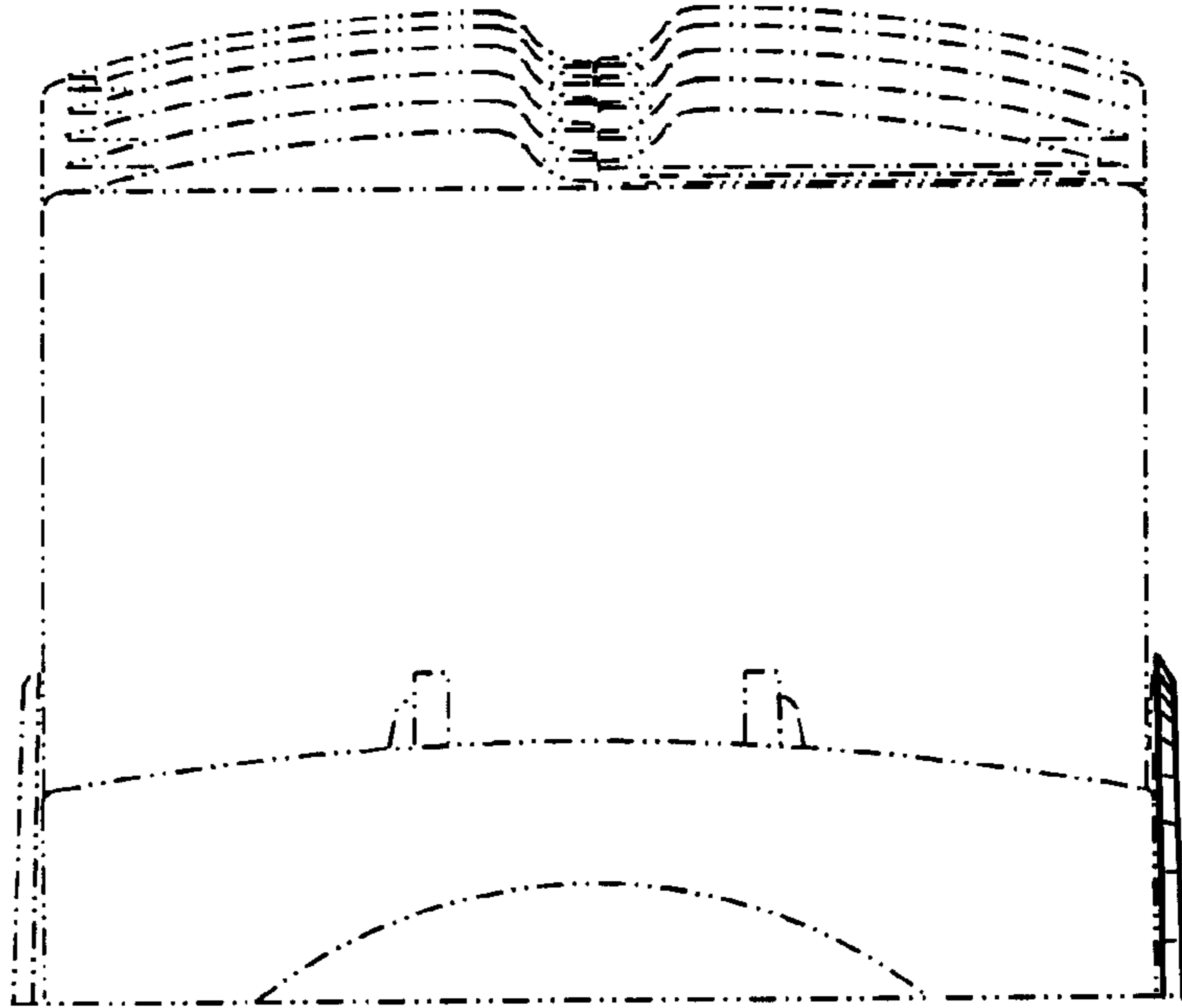

FIG. 10

