



US00D431561S

# United States Patent [19]

Horiki et al.

[11] Patent Number: **Des. 431,561**

[45] Date of Patent: **\*\* Oct. 3, 2000**

[54] **PERSONAL COMPUTER**

[75] Inventors: **Toshio Horiki; Tetsuji Abe**, both of Osaka, Japan

[73] Assignee: **Matsushita Electric Industrial Co., Ltd.**, Japan

[\*\*] Term: **14 Years**

[21] Appl. No.: **29/118,471**

[22] Filed: **Feb. 9, 2000**

### [30] Foreign Application Priority Data

Aug. 23, 1999 [JP] Japan ..... 11-22595

[51] **LOC (7) Cl.** ..... **14-02**

[52] **U.S. Cl.** ..... **D14/337; D14/336**

[58] **Field of Search** ..... D14/337, 336, D14/375, 382, 126-129; 345/104, 133, 156, 168, 173; 361/680-686; 364/708.1, 709.04; 358/249, 254, 255

### [56] References Cited

#### U.S. PATENT DOCUMENTS

D. 361,550 8/1995 Mundt et al. .... D14/337

D. 406,824 3/1999 Minemoto et al. .... D14/375  
D. 409,163 5/1999 Maruyama et al. .... D14/337  
D. 413,105 8/1999 Jobs et al. .... D14/382

*Primary Examiner*—Freda Nunn  
*Attorney, Agent, or Firm*—SAIDMAN DesignLaw Group

### [57] CLAIM

The ornamental design for a personal computer, as shown and described.

### DESCRIPTION

FIG. 1 is a perspective view of the top, front and right side of a personal computer showing our new design;

FIG. 2 is a front elevational view thereof;

FIG. 3 is a right side view thereof;

FIG. 4 is a top plan view thereof;

FIG. 5 is a bottom view thereof;

FIG. 6 is a rear view thereof; and,

FIG. 7 is a left side view thereof.

**1 Claim, 4 Drawing Sheets**

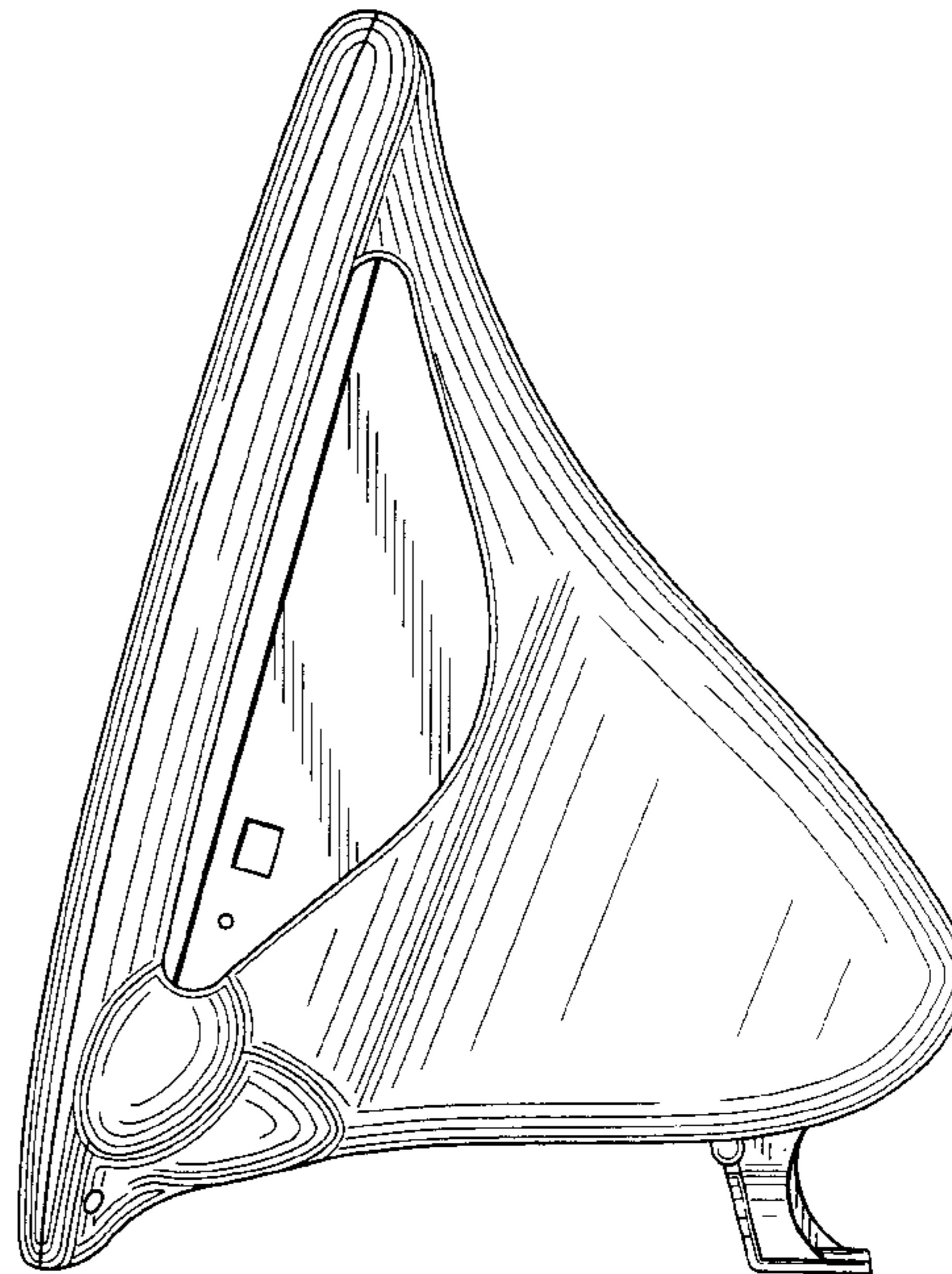
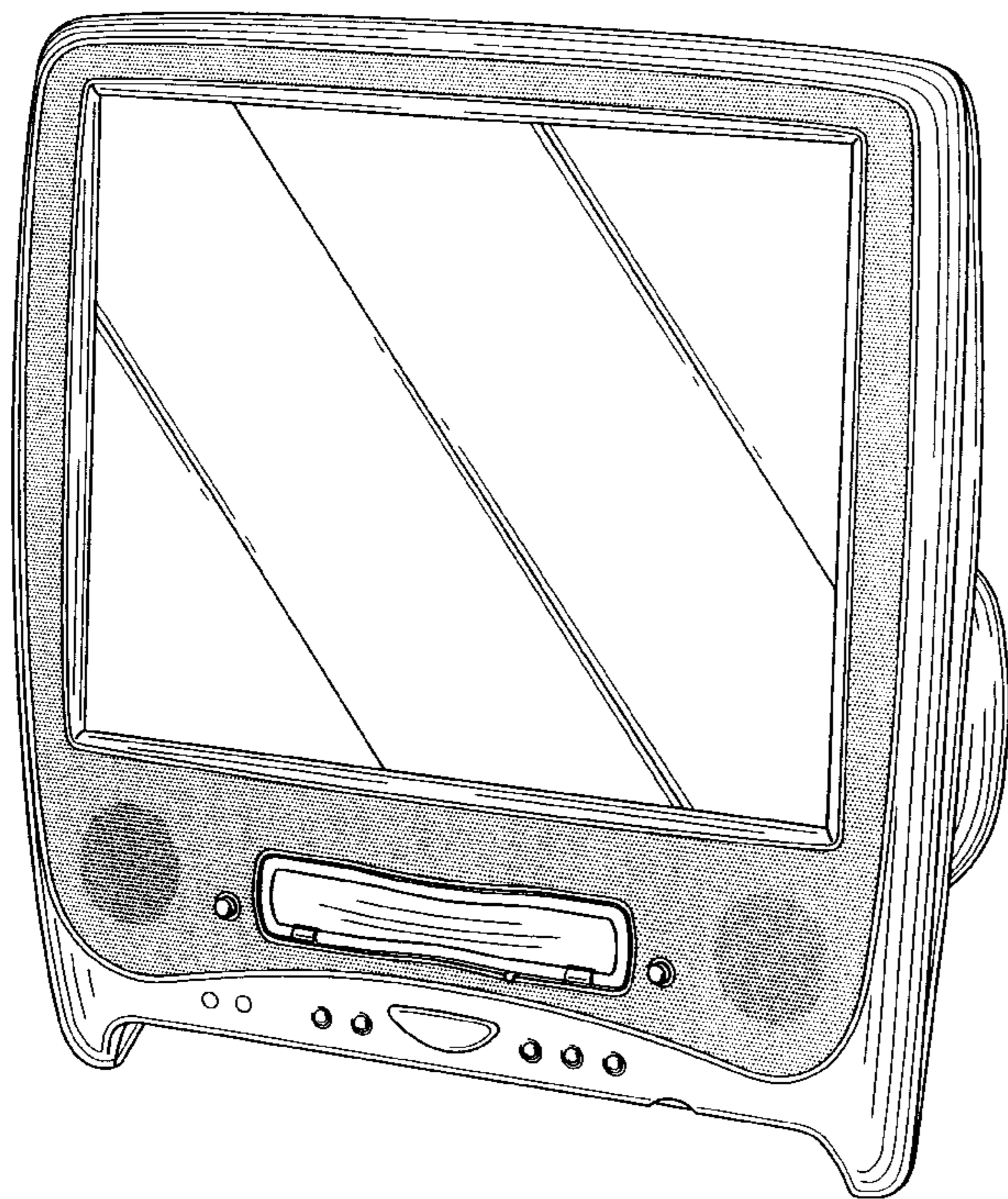

*FIG. 1*

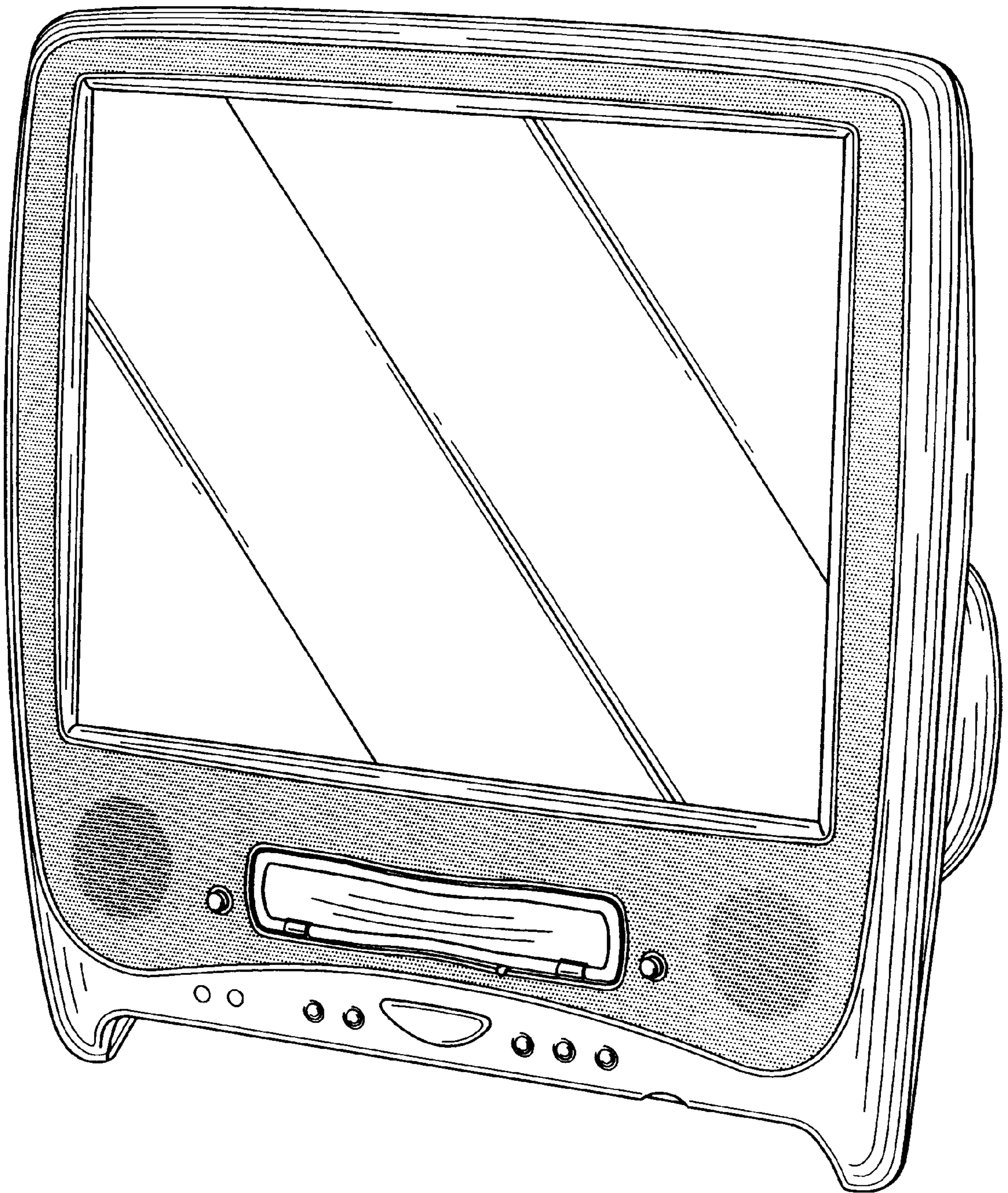

FIG. 3

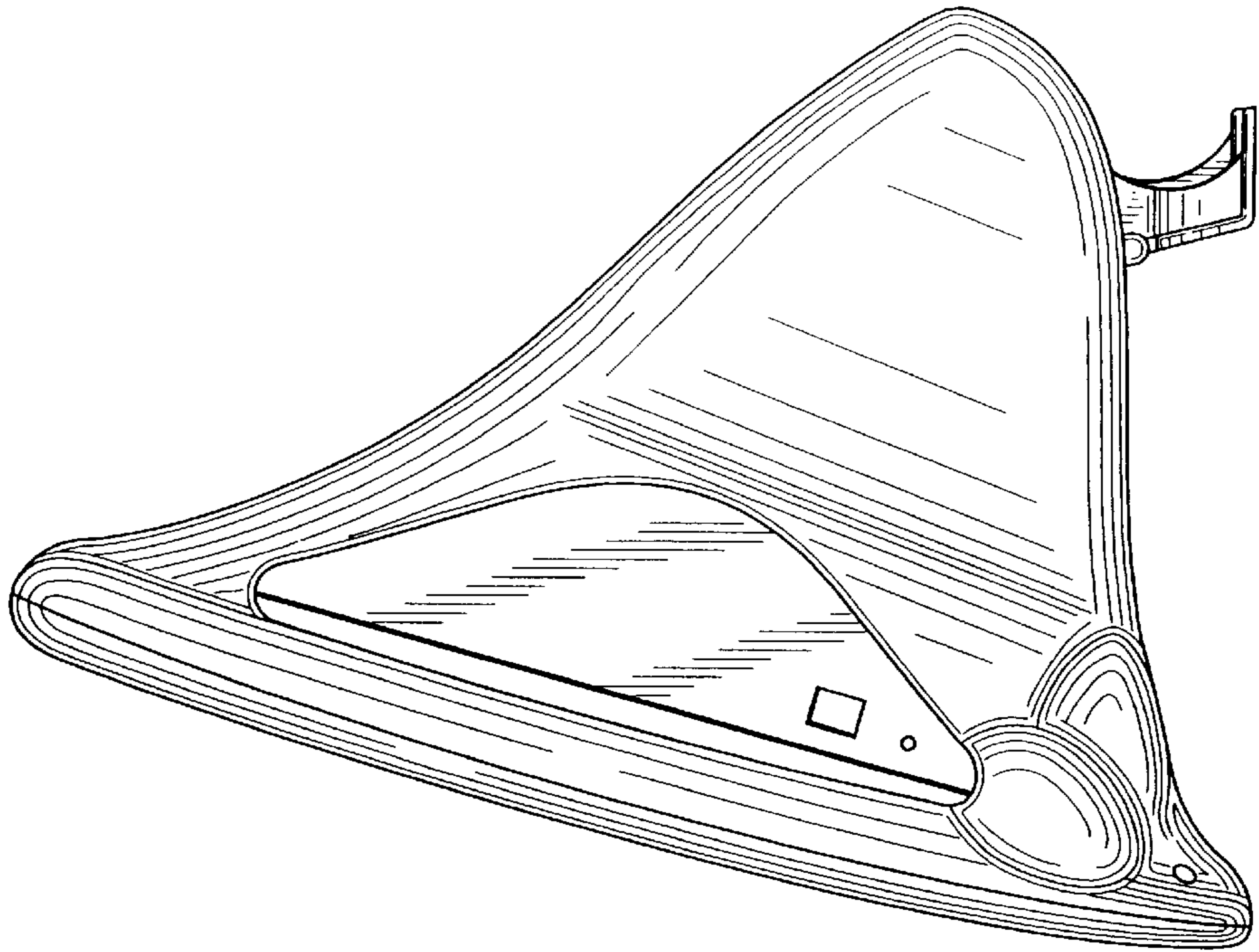
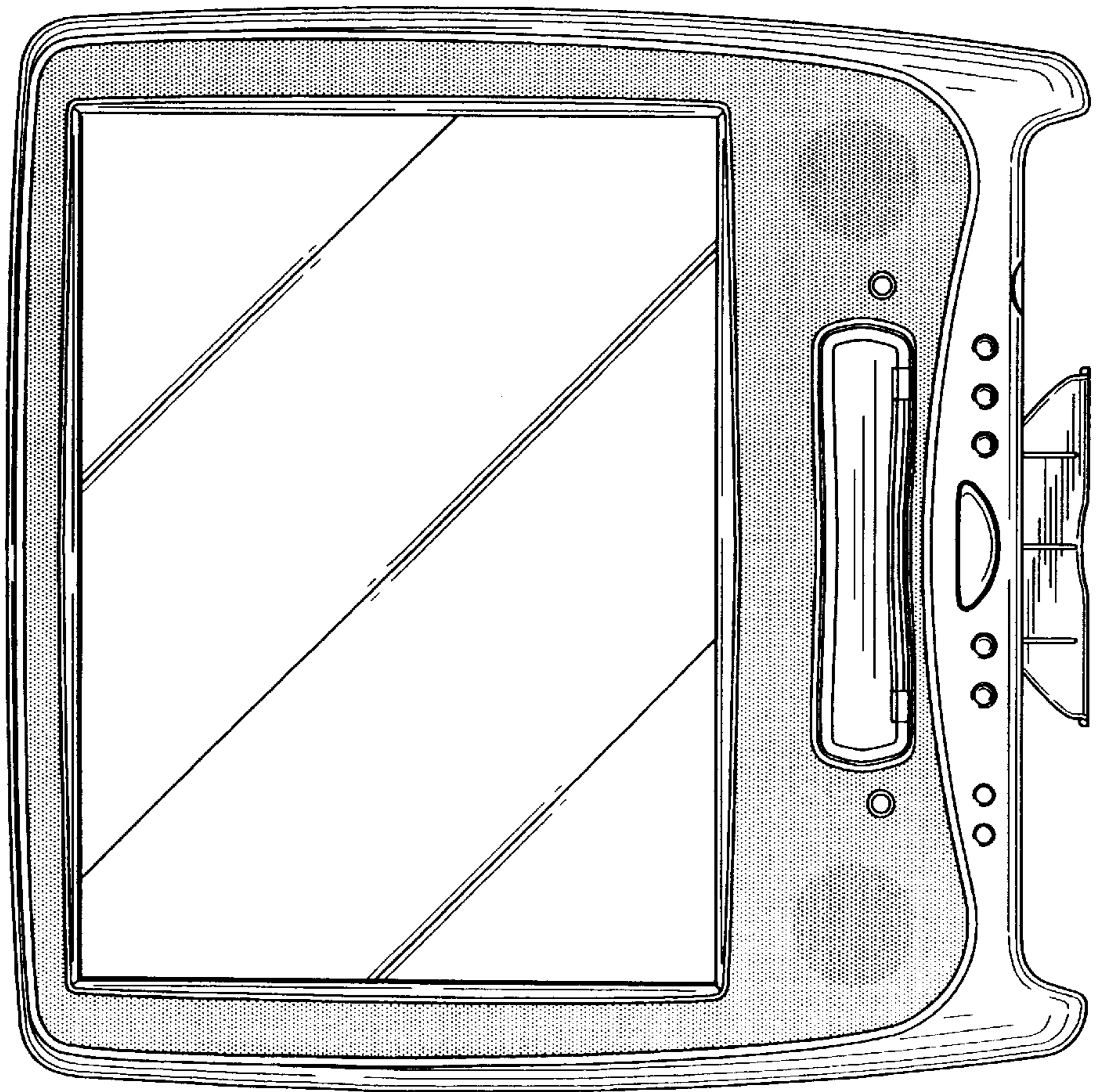
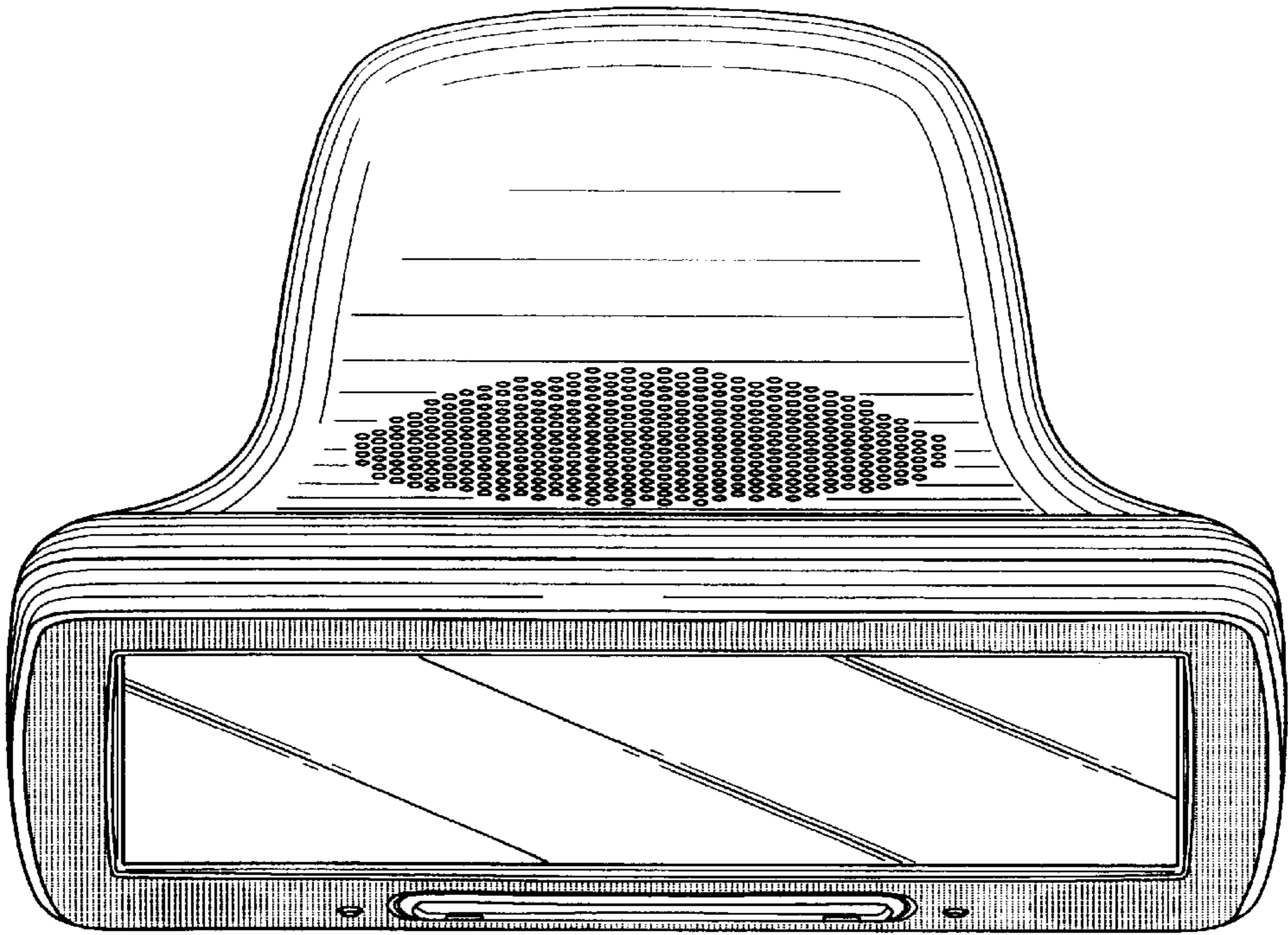

FIG. 2



*FIG. 4*



*FIG. 5*

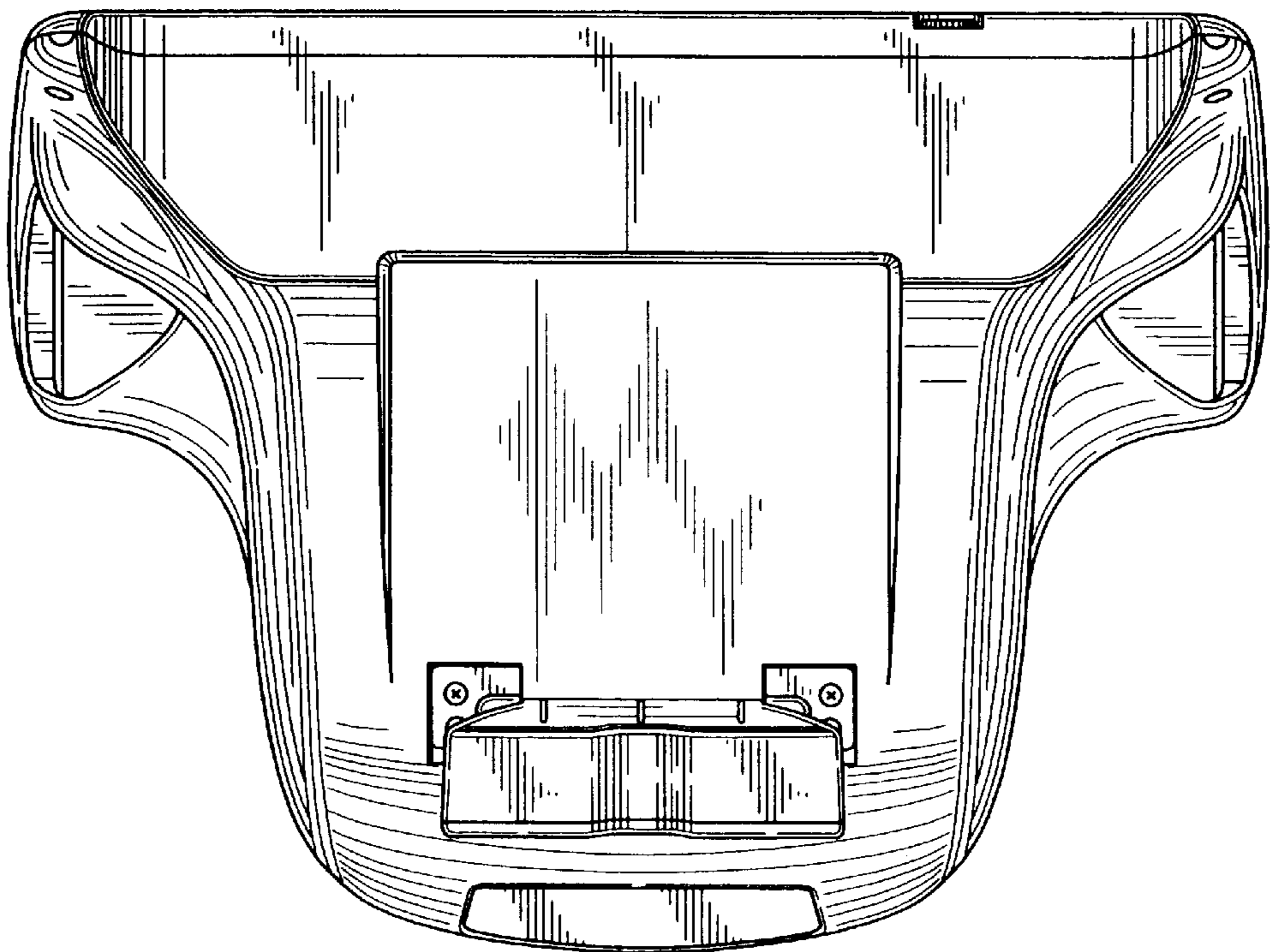

FIG. 7

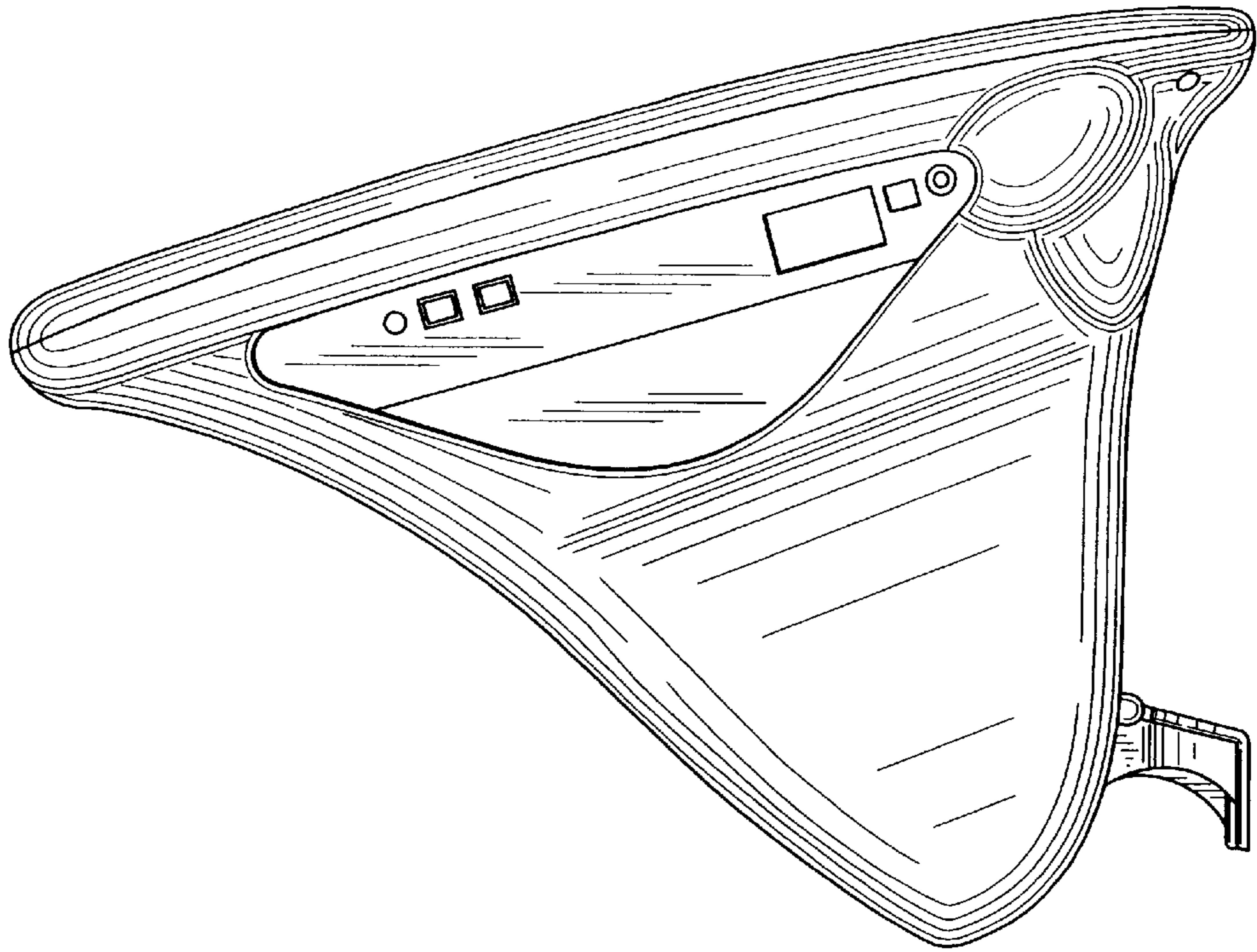

FIG. 6

