



US00D431549S

# United States Patent [19]

Christian et al.

[11] **Patent Number: Des. 431,549**

[45] **Date of Patent: \*\* Oct. 3, 2000**

[54] **HUMOROUS MEGAPHONE**

[75] Inventors: **George T. Christian**, Carlsbad, Calif.;  
**Robert Otis**, 28600 Ridgeway Rd.,  
Sweet Home, Oreg. 97386

[73] Assignee: **Robert Otis**, Sweet Home, Oreg.

[\*\*] Term: **14 Years**

[21] Appl. No.: **29/099,253**

[22] Filed: **Jan. 19, 1999**

[51] **LOC (7) Cl.** ..... **14-03**

[52] **U.S. Cl.** ..... **D14/187**

[58] **Field of Search** ..... D10/104, 106,  
D10/120; D14/185-187, 204, 208; 181/177,  
178, 179, 190

[56] **References Cited**

**U.S. PATENT DOCUMENTS**

- D. 55,295 5/1920 Marsico ..... D10/120
- D. 232,239 7/1974 Schaffer ..... D10/120

- D. 303,530 9/1989 Baer ..... D14/204
- D. 338,464 8/1993 Darby ..... D14/204 X
- 5,094,317 3/1992 Ladendorf ..... D14/204 X
- 5,675,133 10/1997 Kobayashi ..... 181/190 X

*Primary Examiner*—Nanda Bondade  
*Attorney, Agent, or Firm*—John J. Murphey

[57] **CLAIM**

The ornamental design of a humorous megaphone, substantially as shown and described.

**DESCRIPTION**

FIG. 1 is a side view of a megaphone showing our new design, the opposite side being a mirror image thereof; FIG. 2 is a front view thereof; FIG. 3 is a rear view thereof; FIG. 4 is a top view thereof; FIG. 5 is a bottom view thereof; FIG. 6 is a perspective view thereof; and, FIG. 7 is another perspective view of our humorous megaphone with the tongue fully extended therefrom.

**1 Claim, 3 Drawing Sheets**

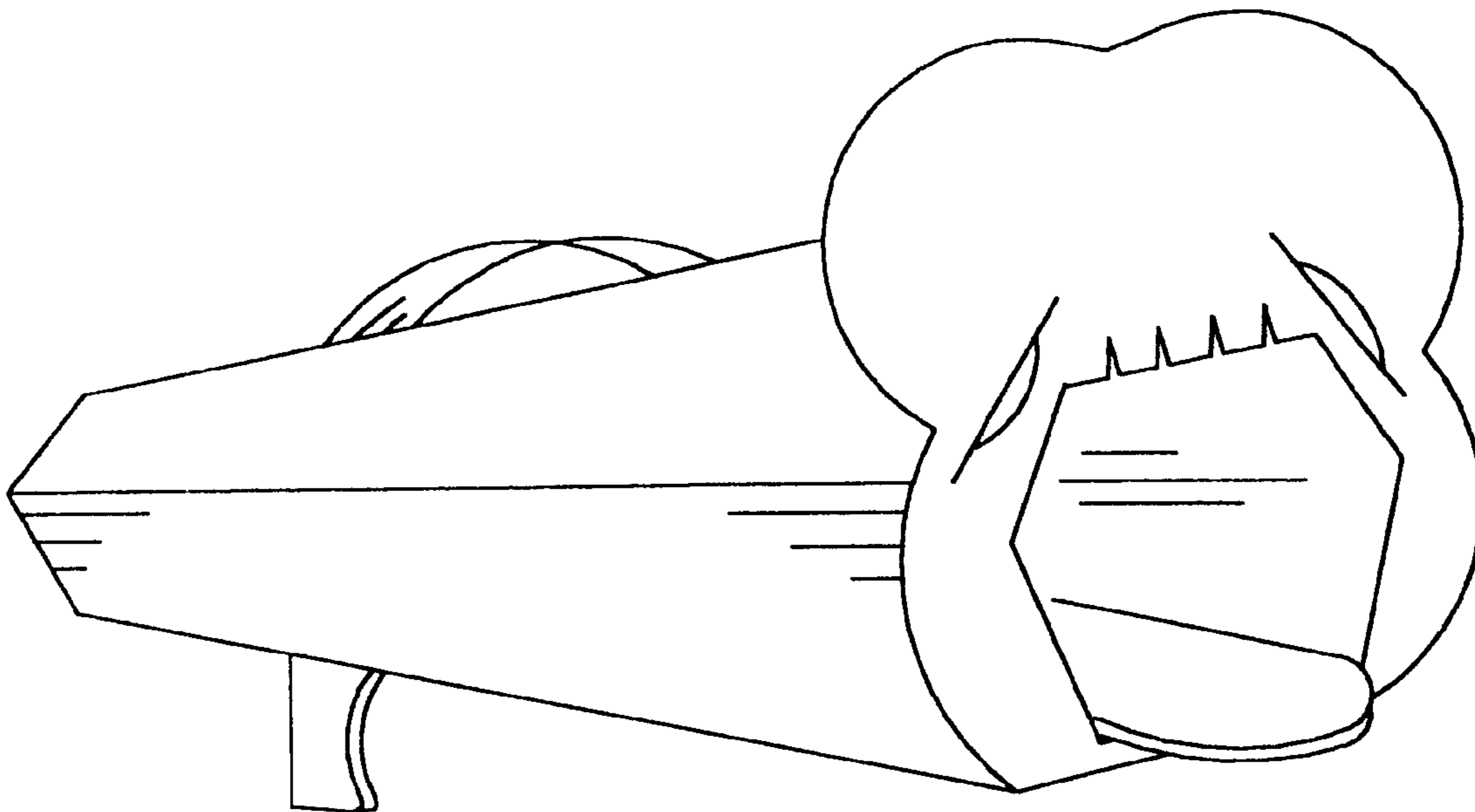

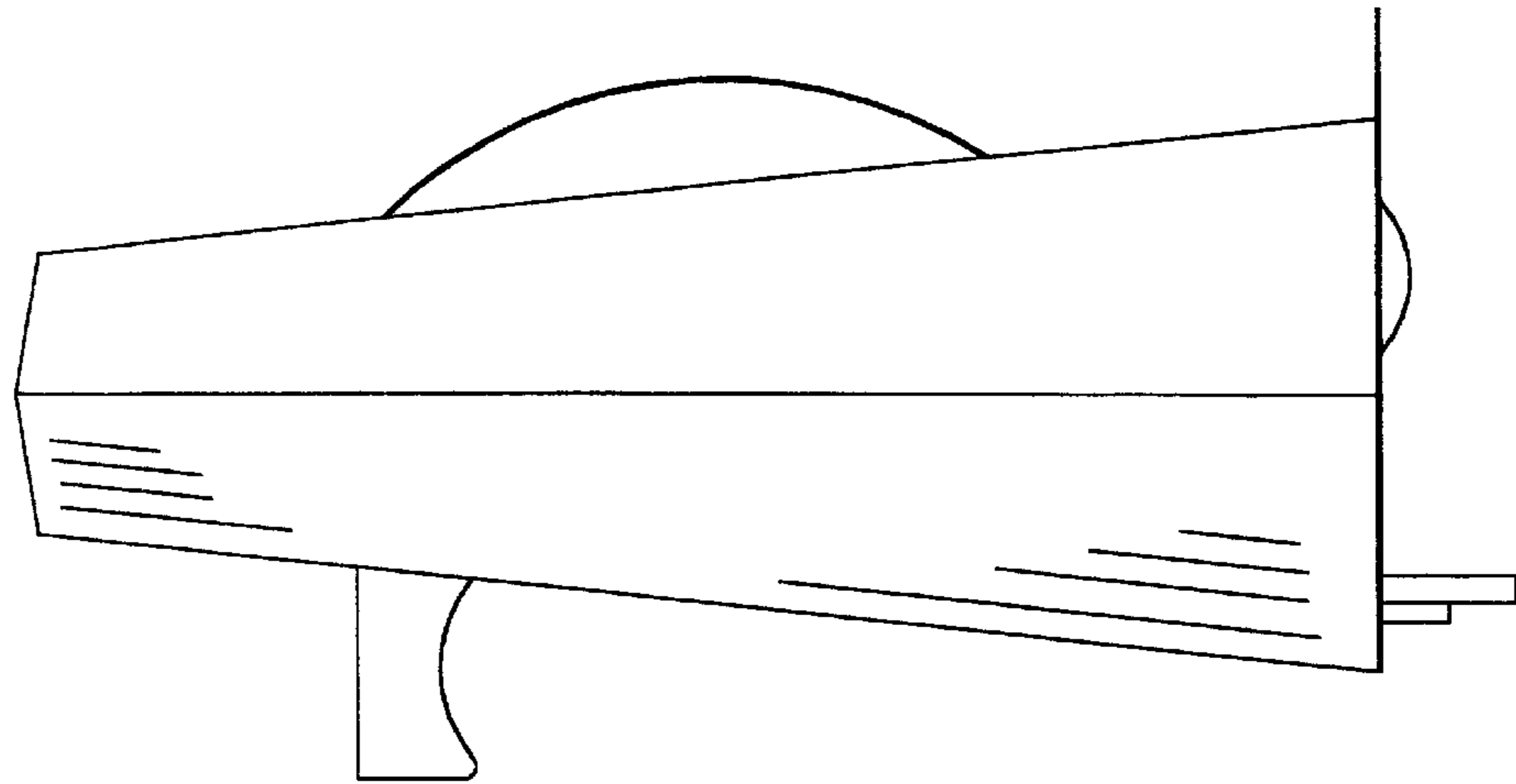

Fig. 1

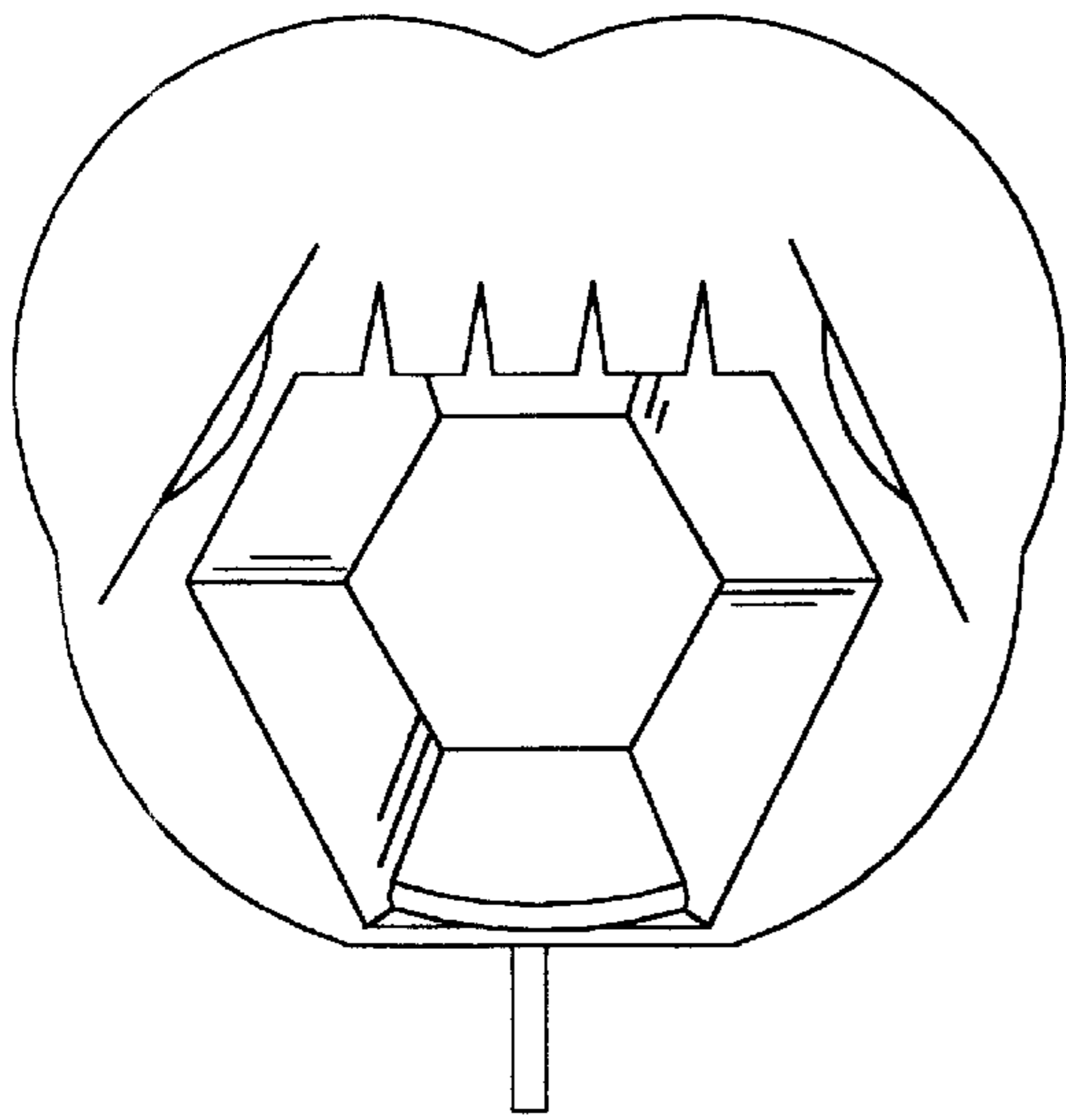

Fig. 2

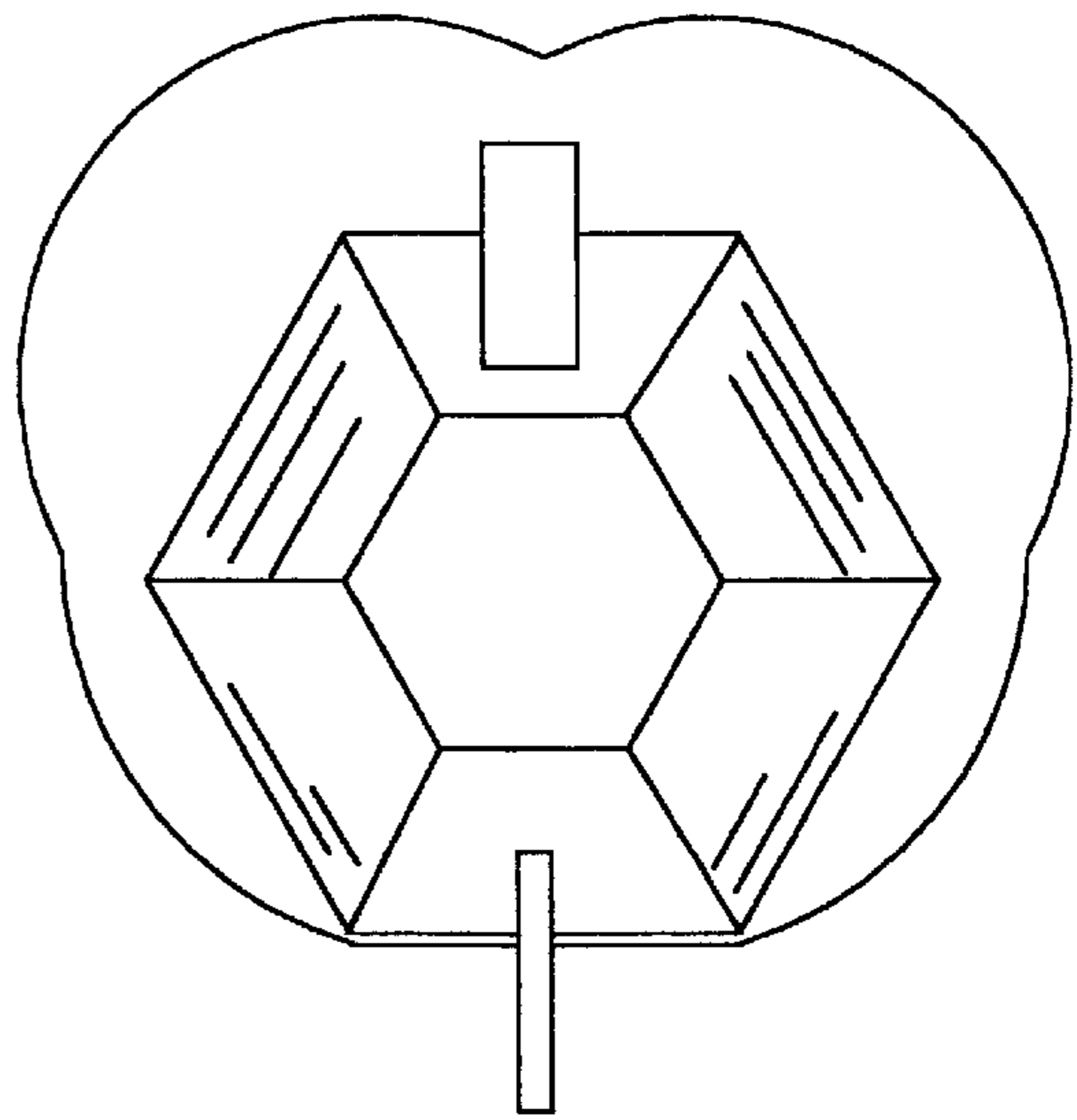

Fig. 3

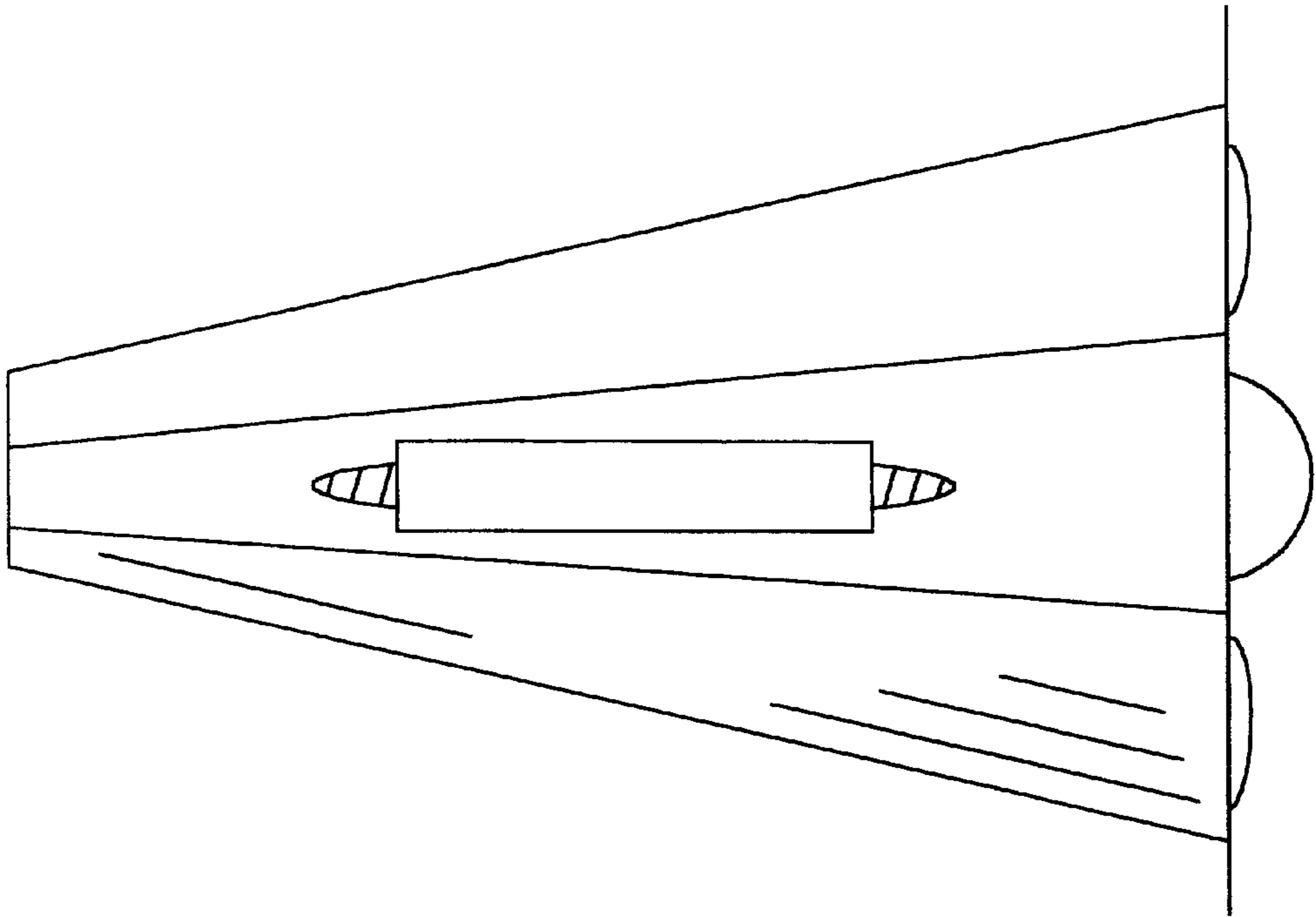

Fig. 4

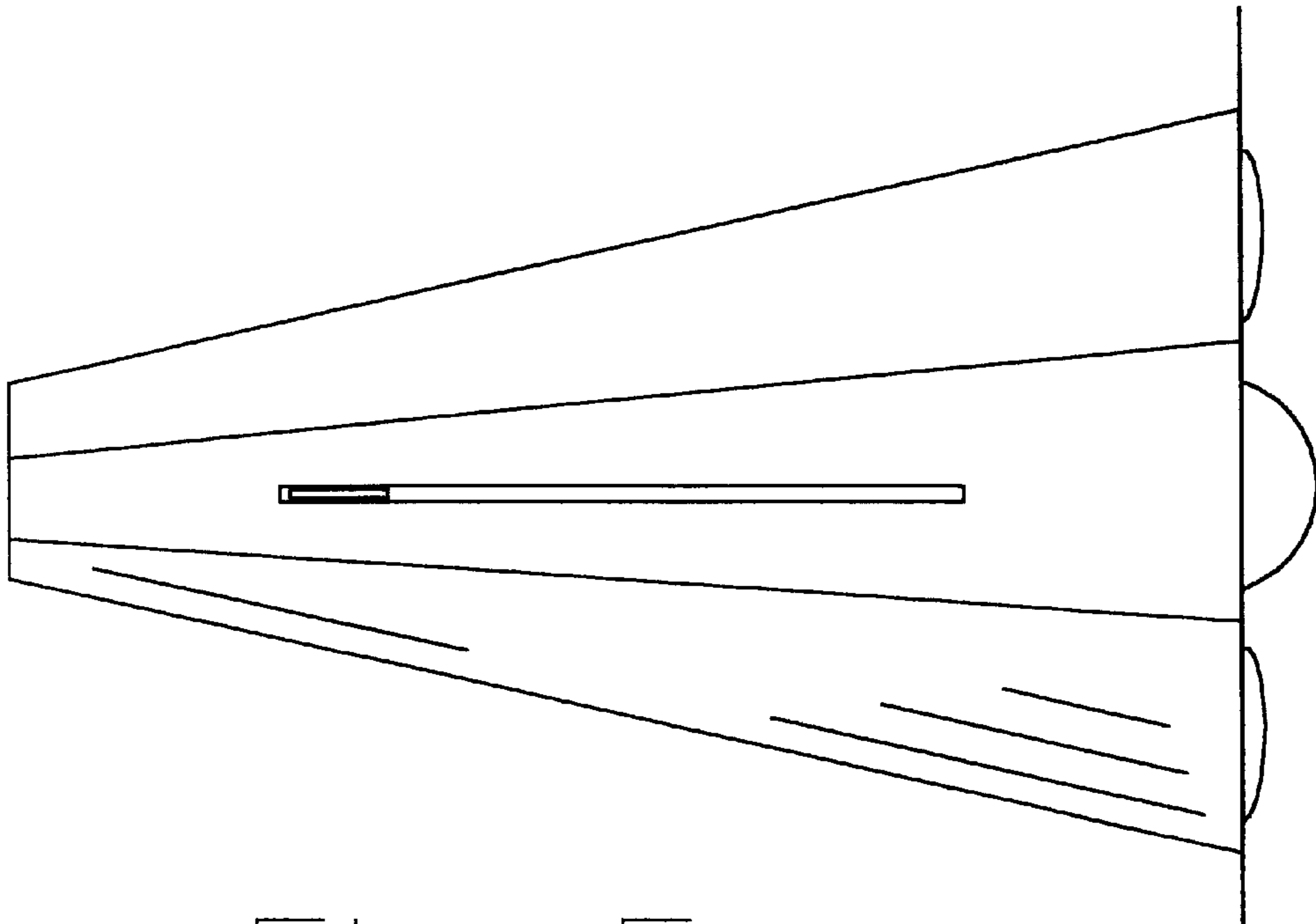

Fig. 5

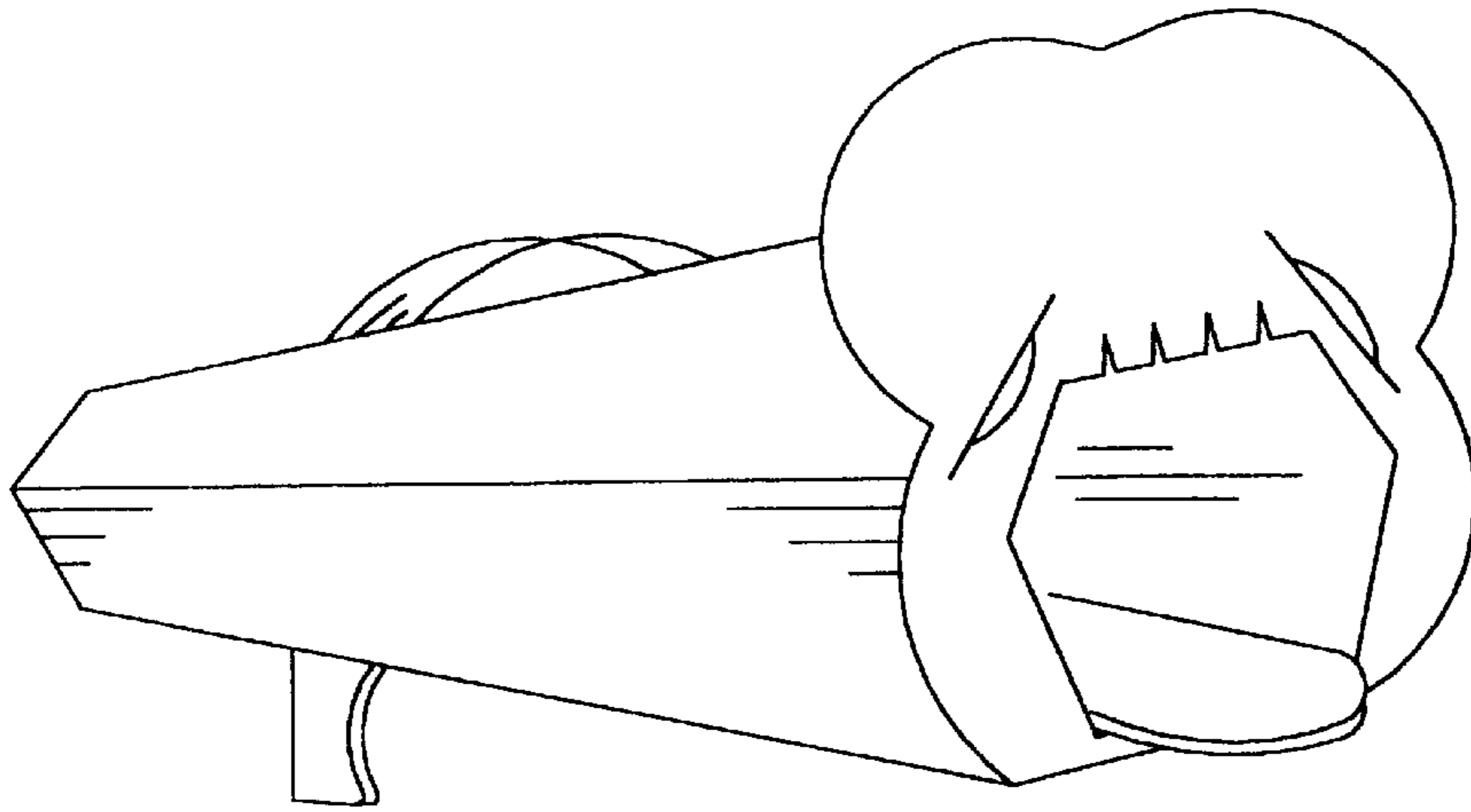

Fig. 6

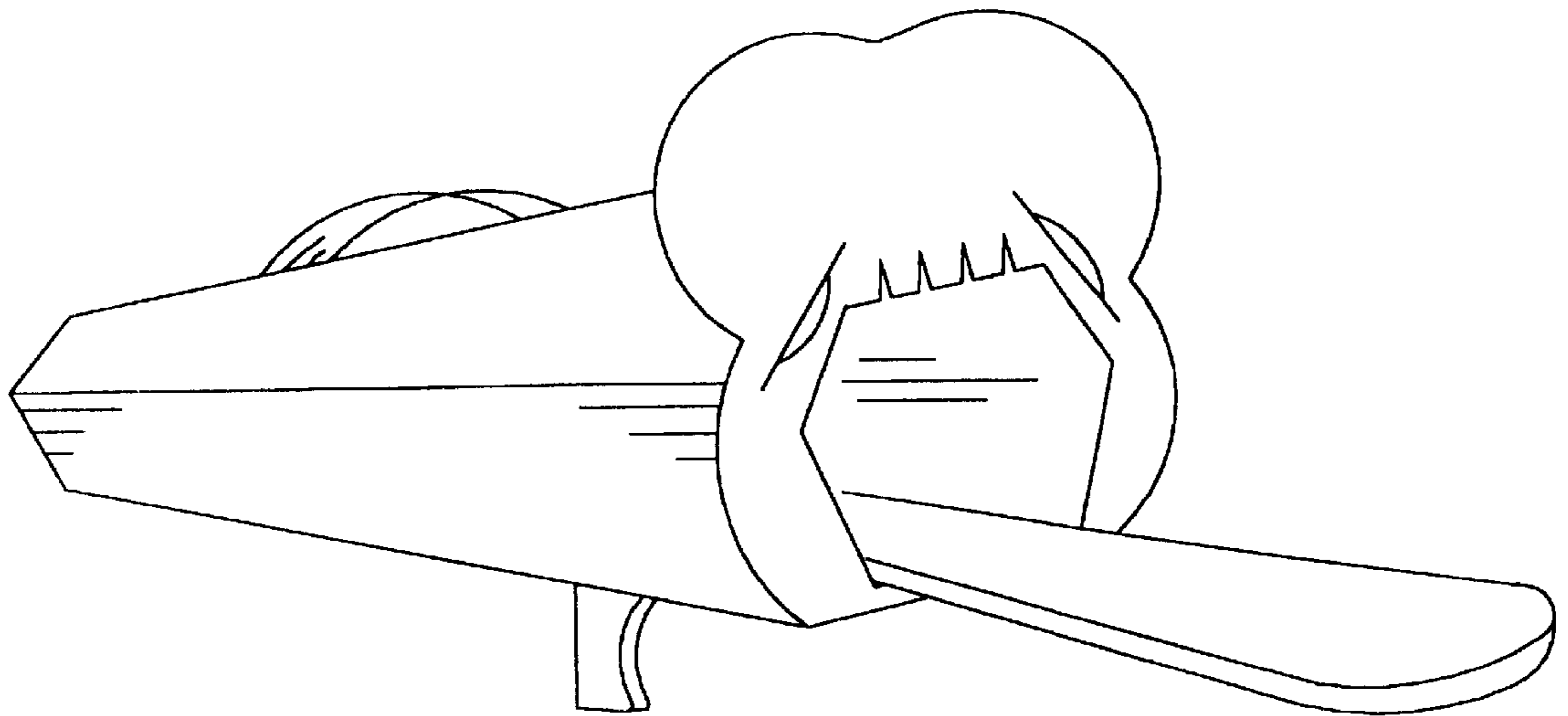

Fig. 7