



US00D431466S

United States Patent [19]
Wang

[11] **Patent Number: Des. 431,466**

[45] **Date of Patent: ** Oct. 3, 2000**

[54] **CARRYING ATTACHMENT FOR A BOTTLE**

[76] Inventor: **Jinn-Yih Wang**, No 119, Tarn Beei Rd,
Ho Mei Cheng, Chang Hua Hsien,
Taiwan

[**] Term: **14 Years**

[21] Appl. No.: **29/114,426**

[22] Filed: **Nov. 24, 1999**

[51] **LOC (7) Cl.** **09-07**

[52] **U.S. Cl.** **D9/434; D7/619**

[58] **Field of Search** D9/434, 455; D3/229;
D7/619, 620; D8/394, 395; 206/148, 427;
224/175, 202, 205, 258; 294/31.2, 159

[56] **References Cited**

U.S. PATENT DOCUMENTS

D. 281,565	12/1985	Salas et al.	D8/395 X
D. 329,964	10/1992	Dobbins et al.	D7/619
D. 346,532	5/1994	Ogden et al.	D7/619
D. 347,734	6/1994	Patterson et al.	D3/229
D. 388,604	1/1998	Castro	D3/229
D. 420,335	2/2000	Salas et al.	D8/395 X

Primary Examiner—Cathron B. Matta
Attorney, Agent, or Firm—Birch, Stewart, Kolasch & Birch,
LLP

[57] **CLAIM**

The ornamental design for a carrying attachment for a bottle,
as shown and described.

DESCRIPTION

FIG. 1 is a front elevational side view of a carrying attachment for a bottle showing my new design.
FIG. 2 is a right side elevational view thereof;
FIG. 3 is a top plan view thereof;
FIG. 4 is a bottom plan view thereof;
FIG. 5 is a left side elevational view thereof;
FIG. 6 is a rear elevational view thereof;
FIG. 7 is a perspective view thereof showing my new design;
FIG. 8 is another perspective view thereof; from the bottom plan view; and,
FIG. 9 is another perspective view on a reduced scale with a bottle and carrying strap shown in broken lines for illustrative purposes only and forming no part of the claimed design.

1 Claim, 2 Drawing Sheets

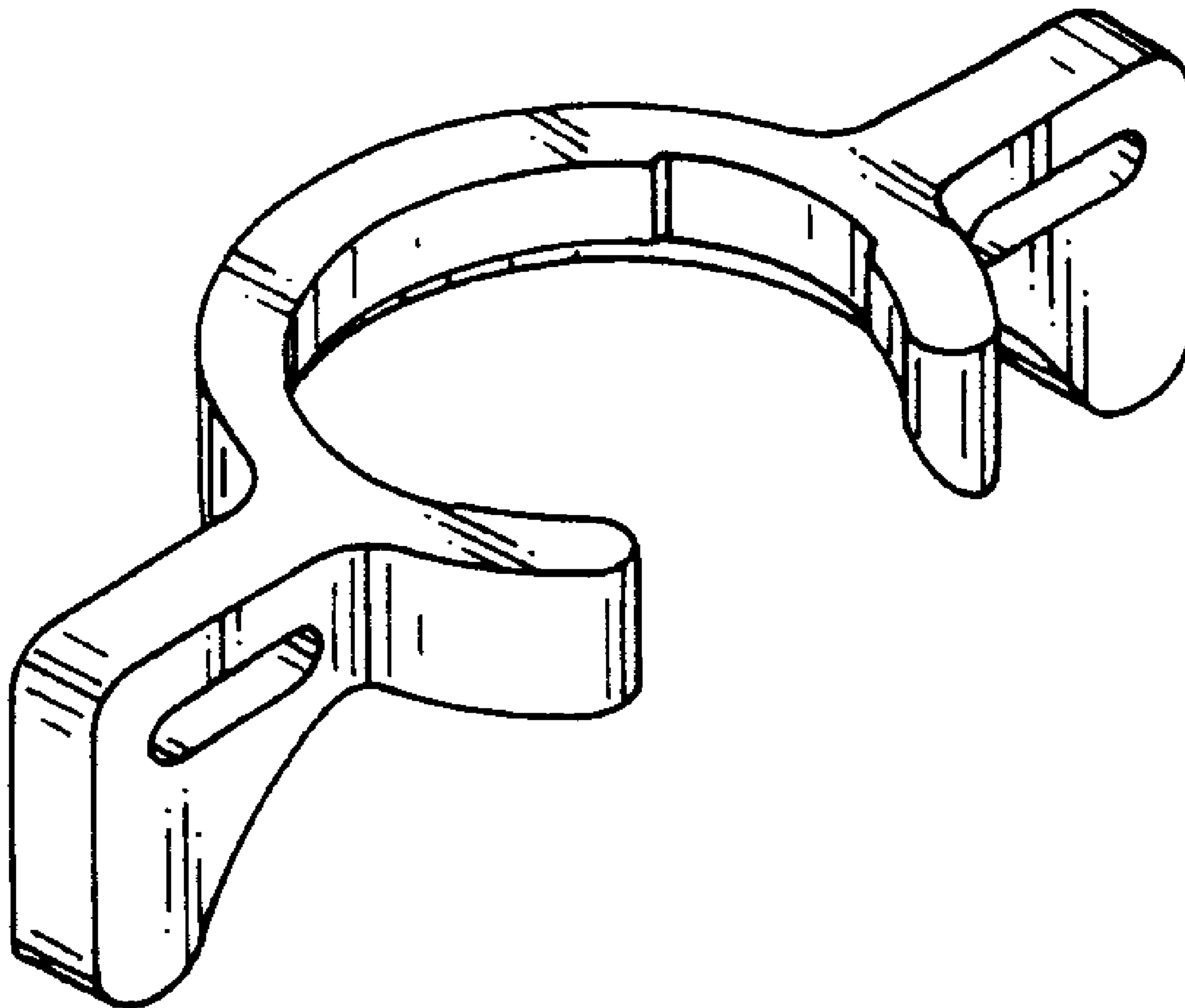

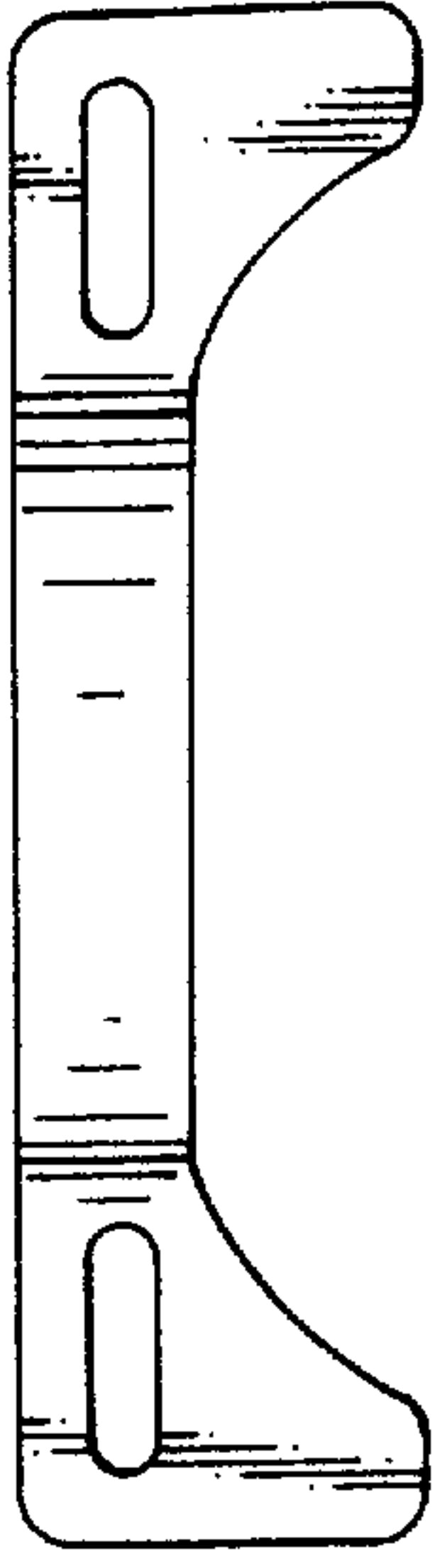

FIG. 6

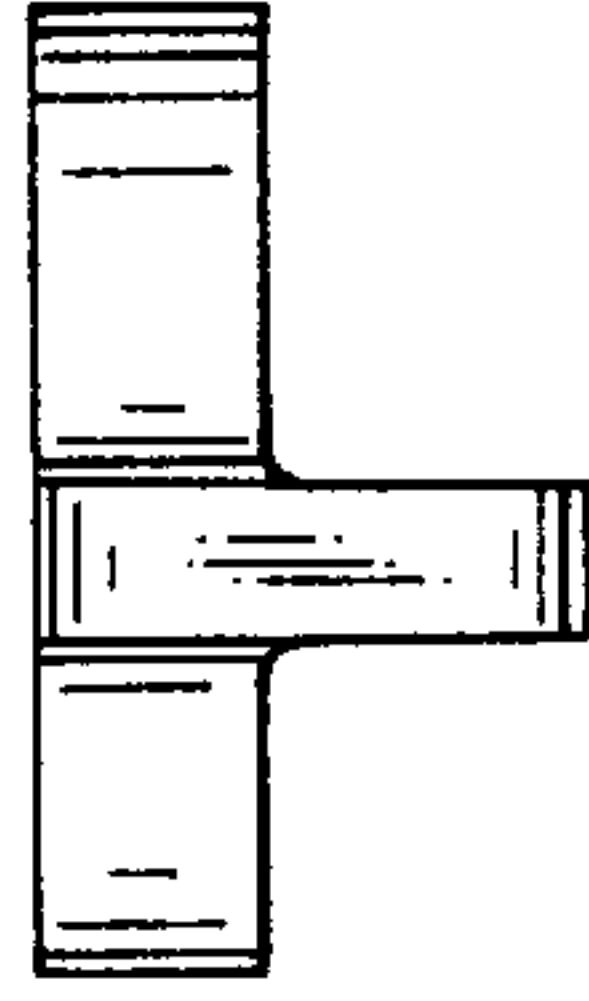

FIG. 2

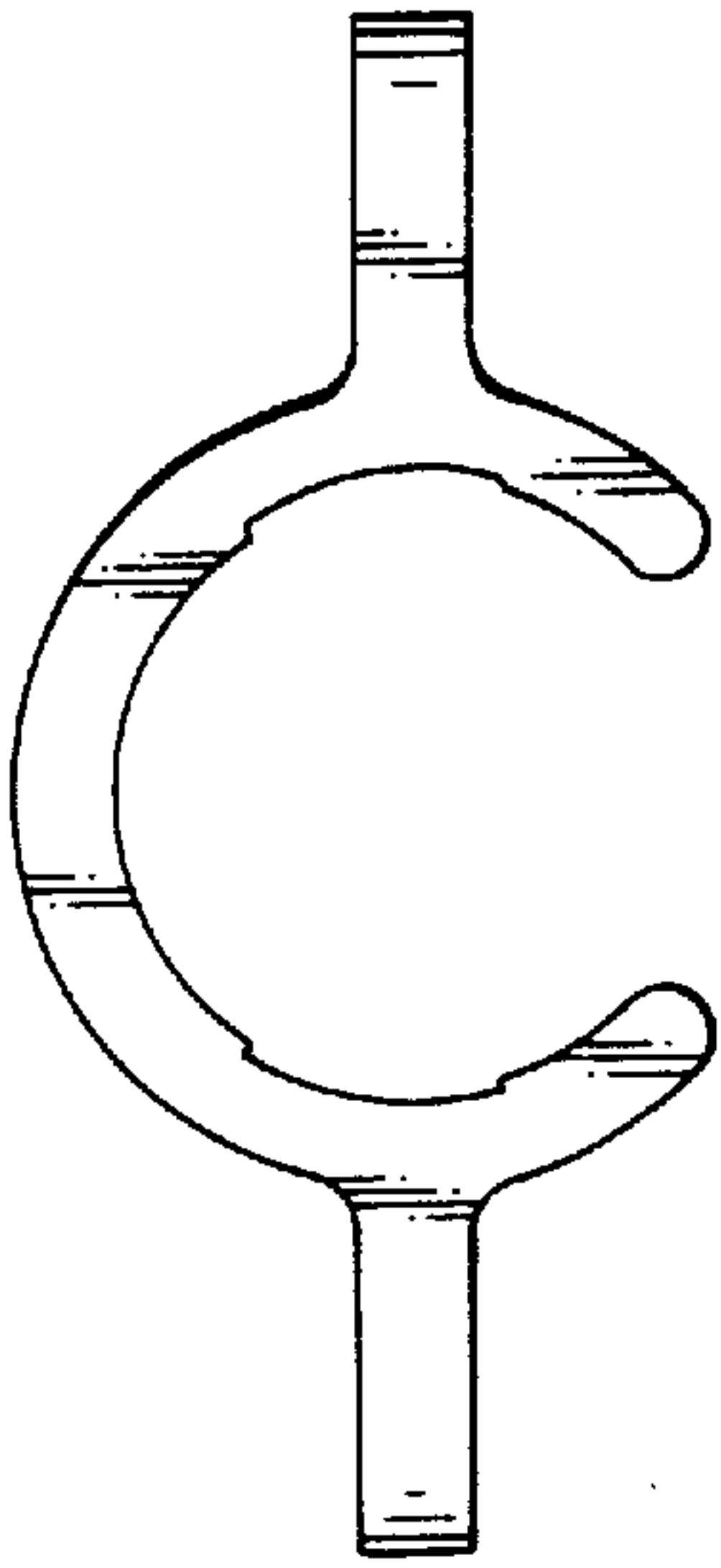

FIG. 3

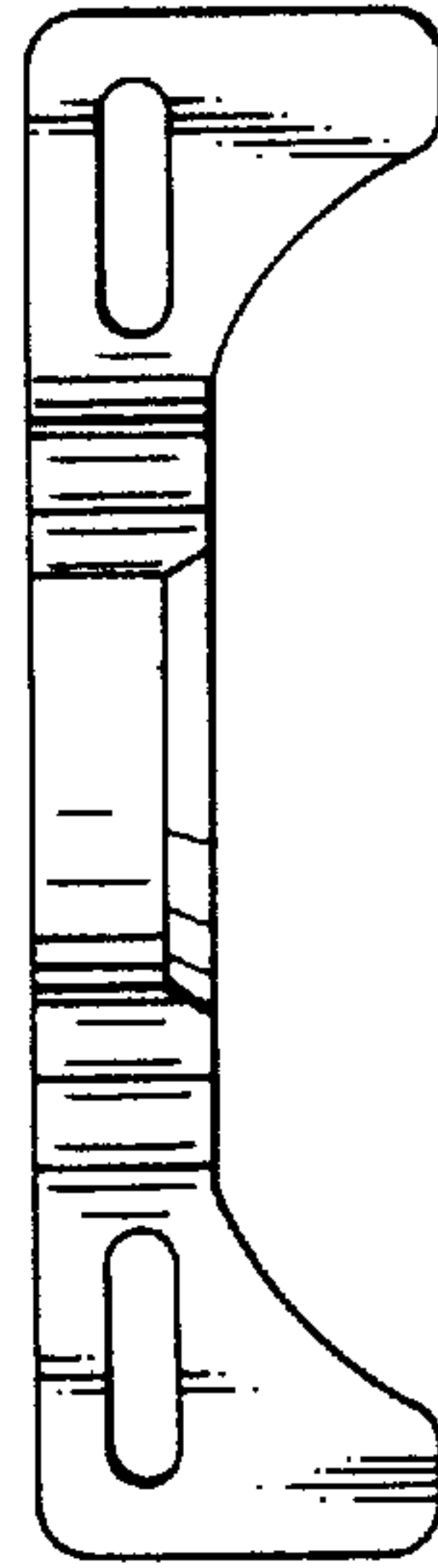

FIG. 1

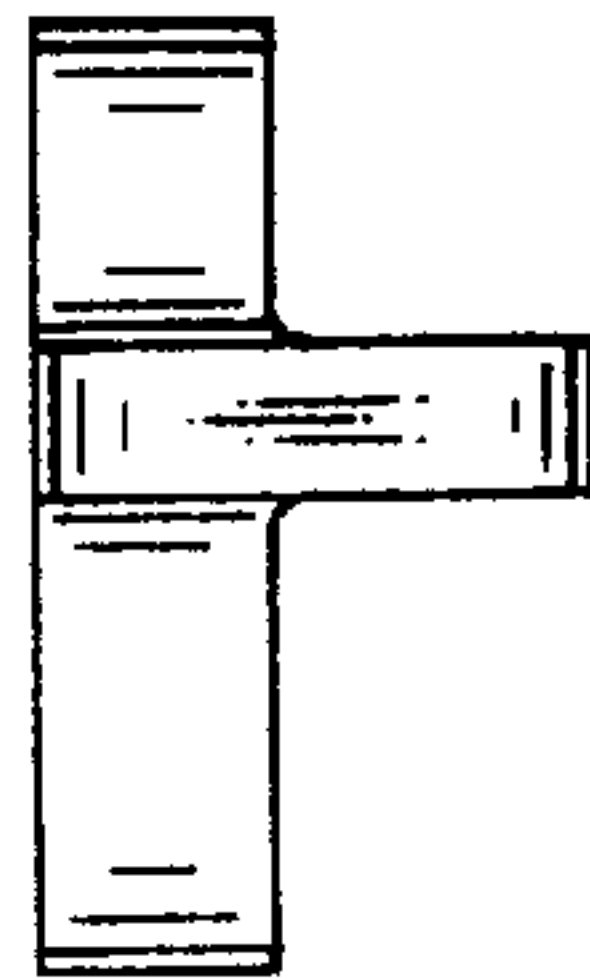

FIG. 5

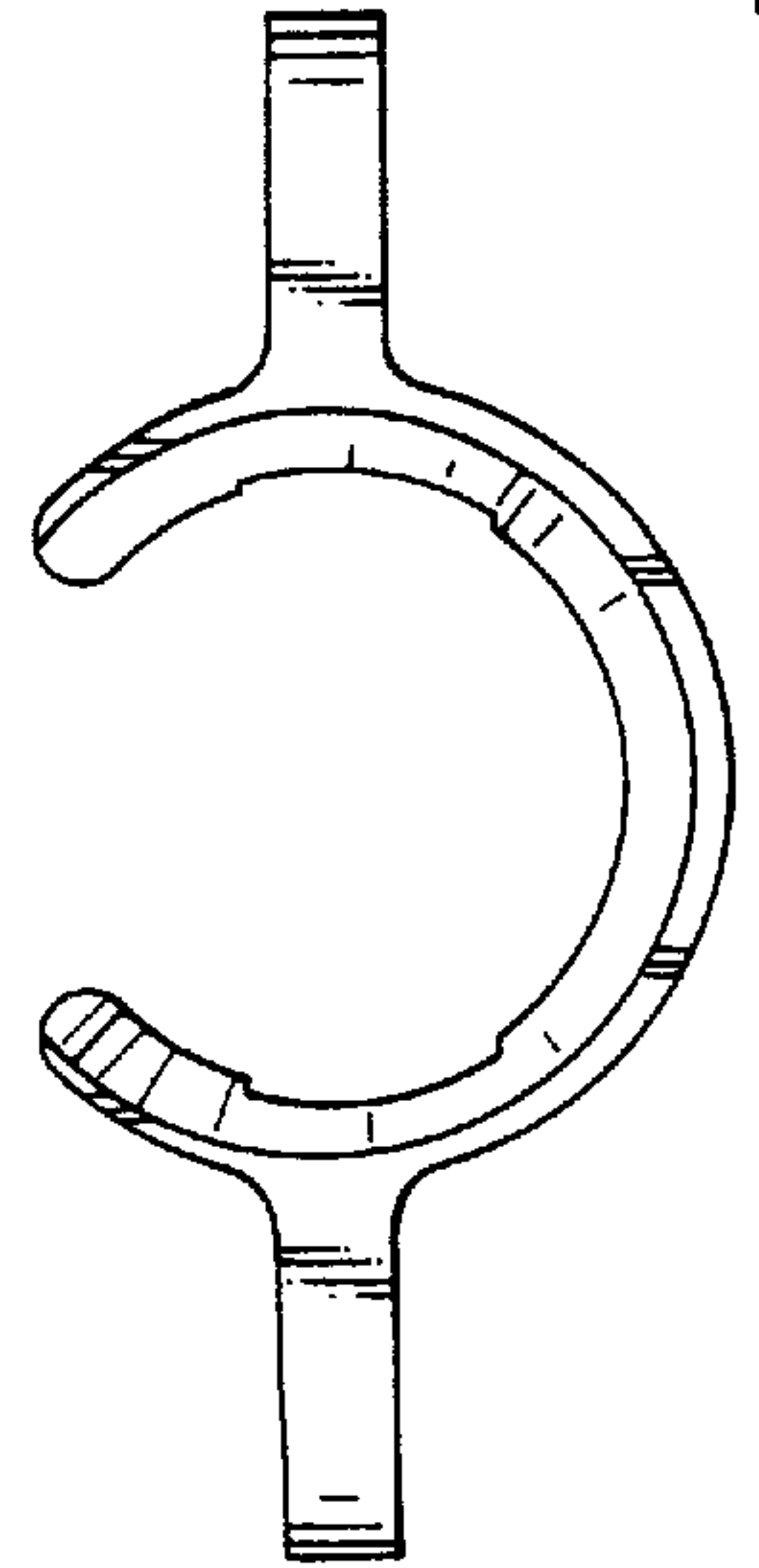

FIG. 4

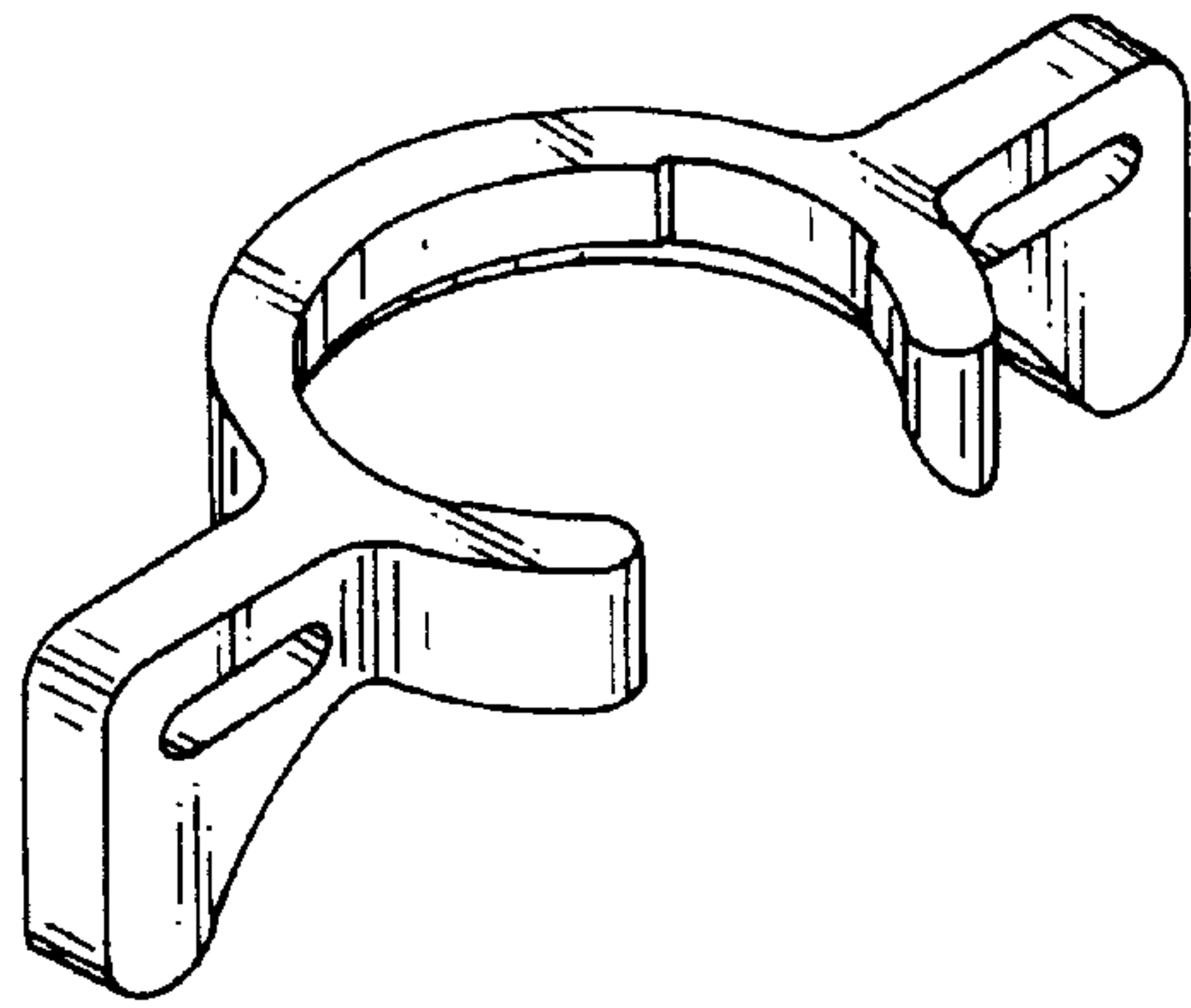

FIG. 7

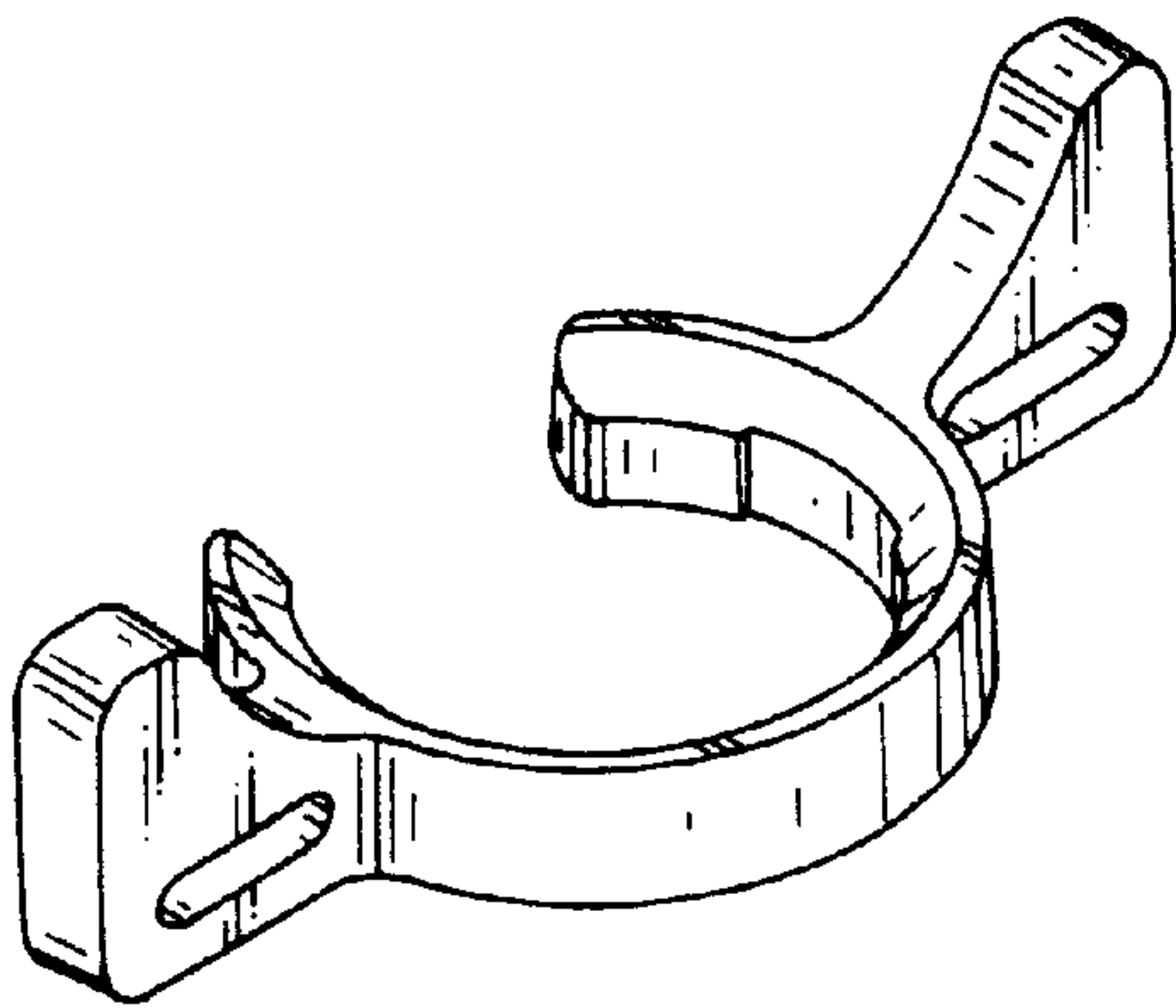

FIG. 8

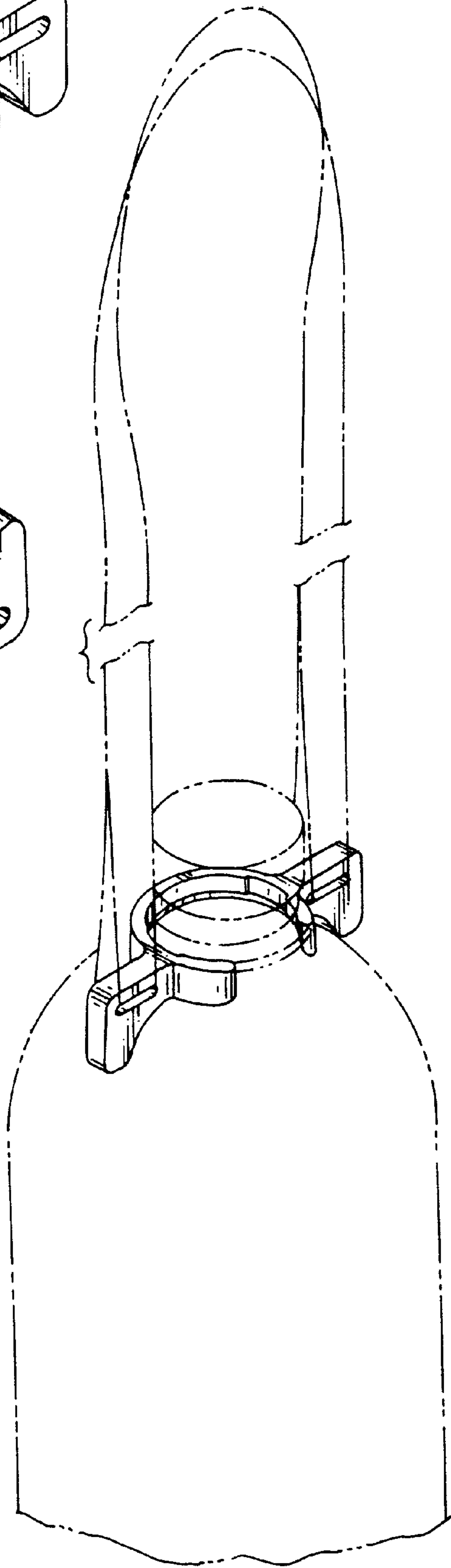

FIG. 9