



US00D431404S

United States Patent [19]

Brazis et al.

[11] Patent Number: **Des. 431,404**

[45] Date of Patent: **** Oct. 3, 2000**

[54] **WALL-MOUNTED LIQUID DISPENSER**

[75] Inventors: **William Brazis**, Medina; **Roger Ramsey**, Akron, both of Ohio

[73] Assignee: **Joseph S. Kanfer**, Richfield, Ohio

[**] Term: **14 Years**

[21] Appl. No.: **29/114,228**

[22] Filed: **Nov. 22, 1999**

[51] **LOC (7) Cl.** **23-02**

[52] **U.S. Cl.** **D6/545**

[58] **Field of Search** D6/542-545; 222/173, 222/180, 181.1, 181.3; 221/282, 283

[56] **References Cited**

U.S. PATENT DOCUMENTS

D. 338,585 8/1993 Bell et al. D6/545

D. 388,990 1/1998 Brandenburg et al. D6/545

D. 401,093 11/1998 Arbak et al. D6/545
D. 416,417 11/1999 Ross et al. D6/545

Primary Examiner—Brian N. Vinson
Attorney, Agent, or Firm—Reese Taylor

[57] **CLAIM**

We claim the ornamental design for a wall-mounted liquid dispenser, as shown and described.

DESCRIPTION

FIG. 1 is a perspective view of a wall-mounted liquid dispenser showing our new design; FIG. 2 is a front elevational view thereof; FIG. 3 is a side elevational view taken from the left of FIG. 2, the right side being a mirror image thereof; FIG. 4 is a rear elevational view thereof; FIG. 5 is a top plan view thereof; and, FIG. 6 is a bottom plan view thereof.

1 Claim, 3 Drawing Sheets

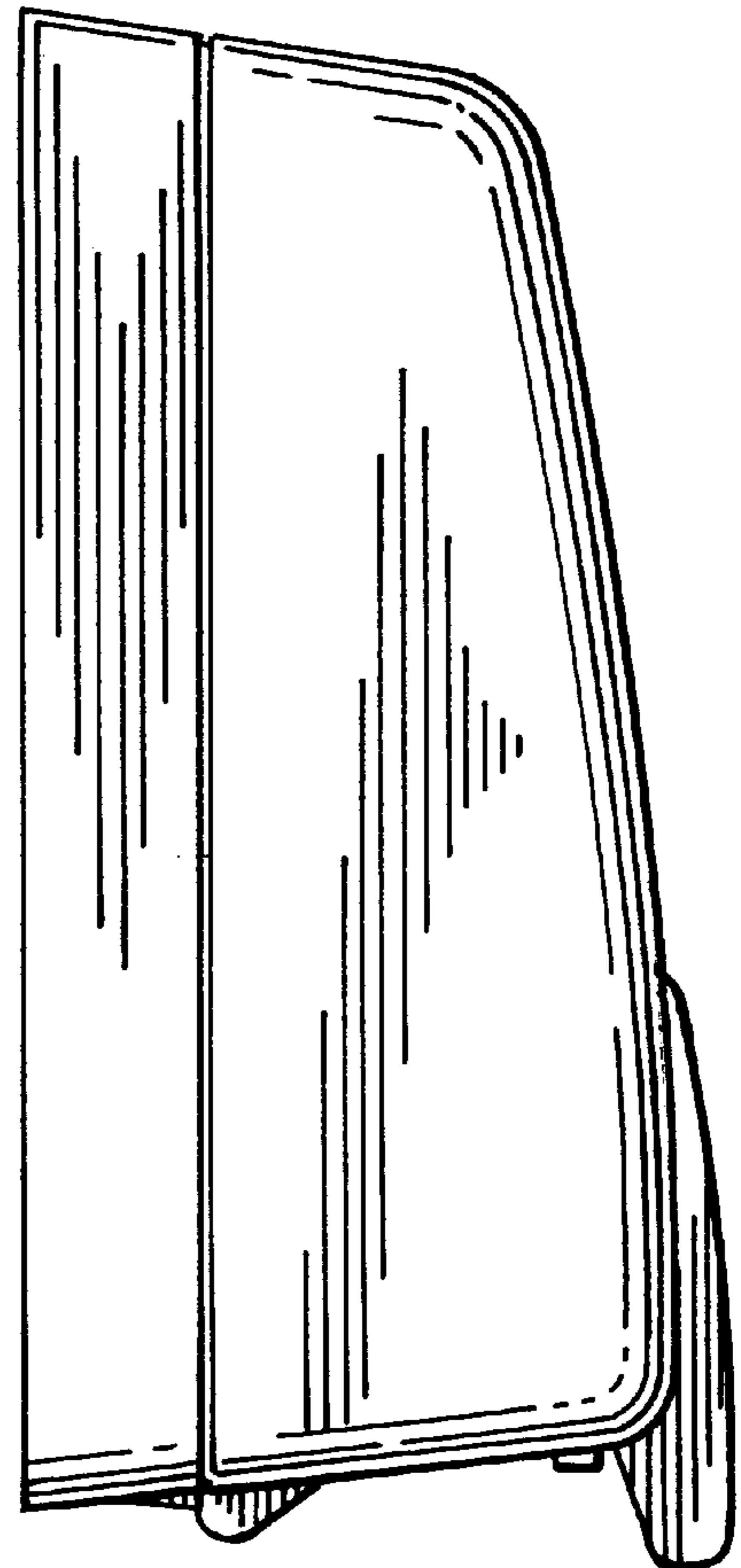
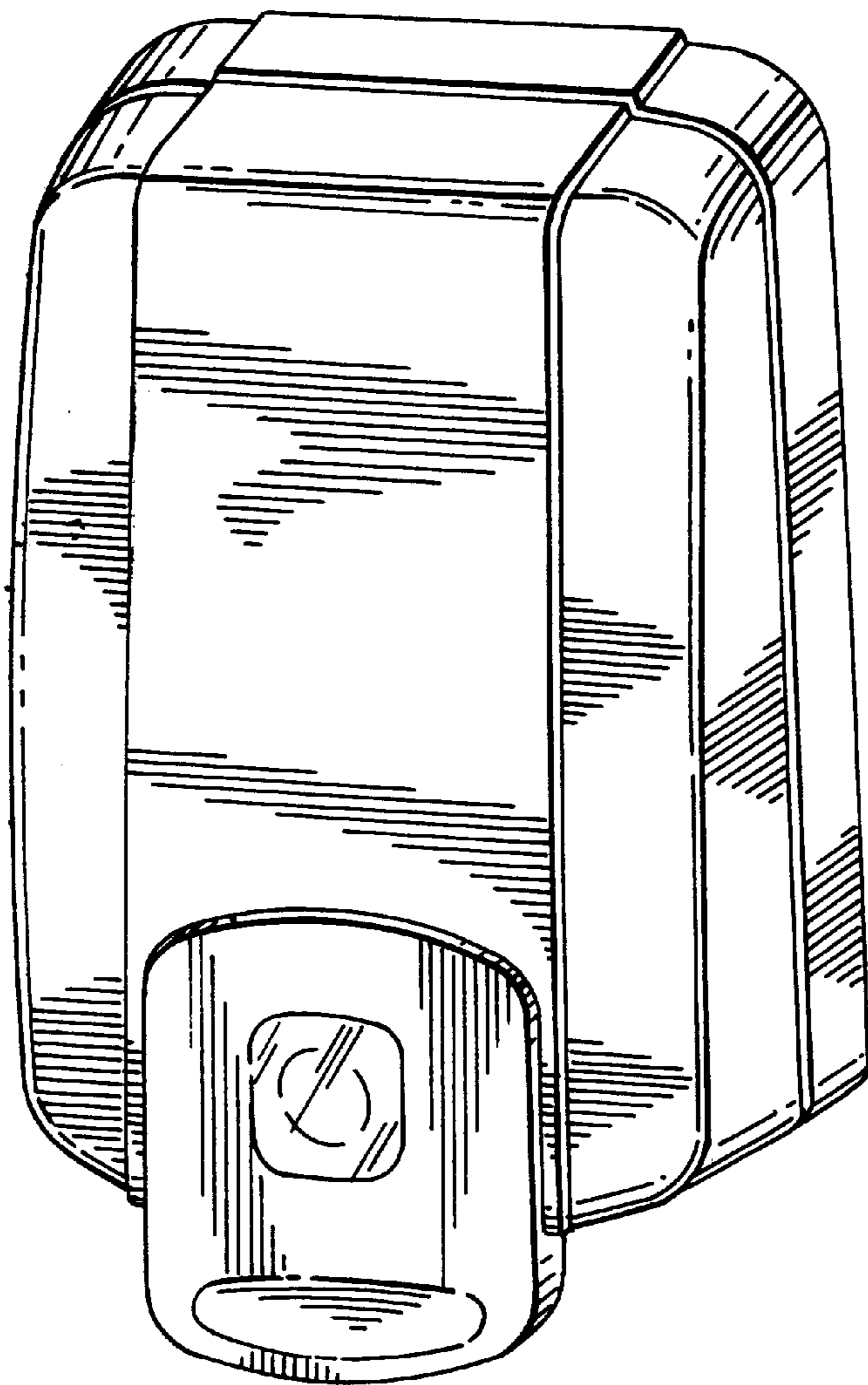

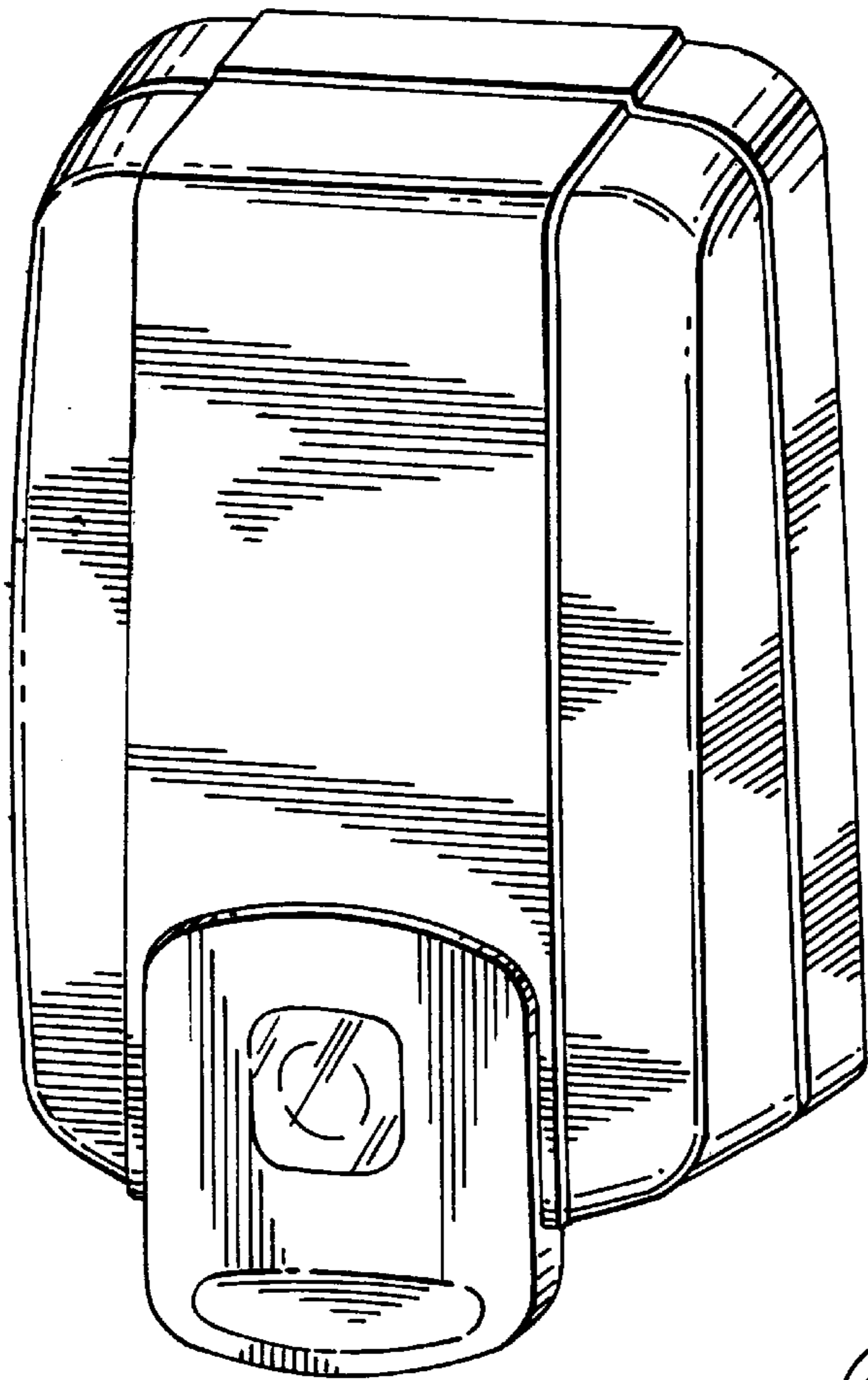

FIG. 1

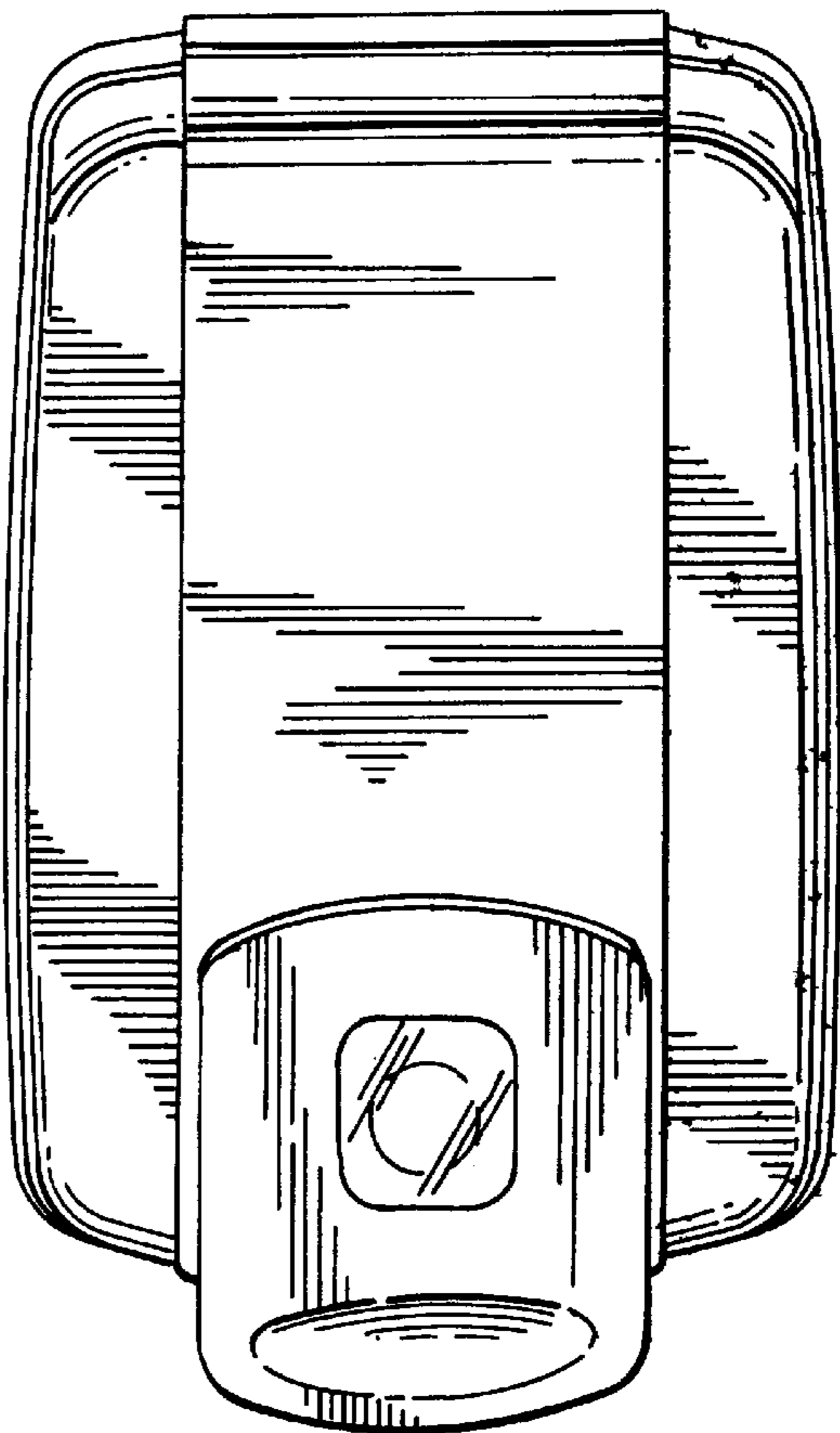

FIG. 2

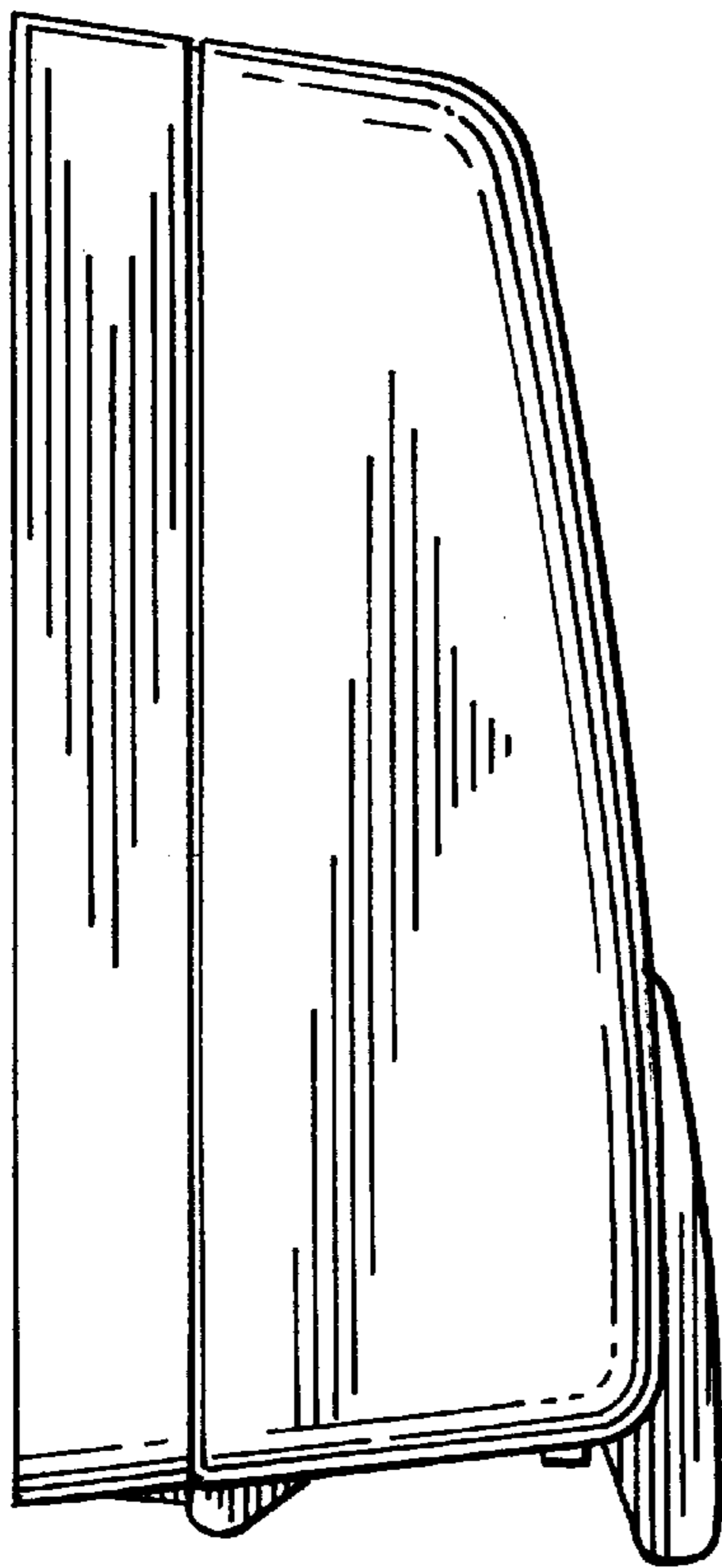

FIG. 3

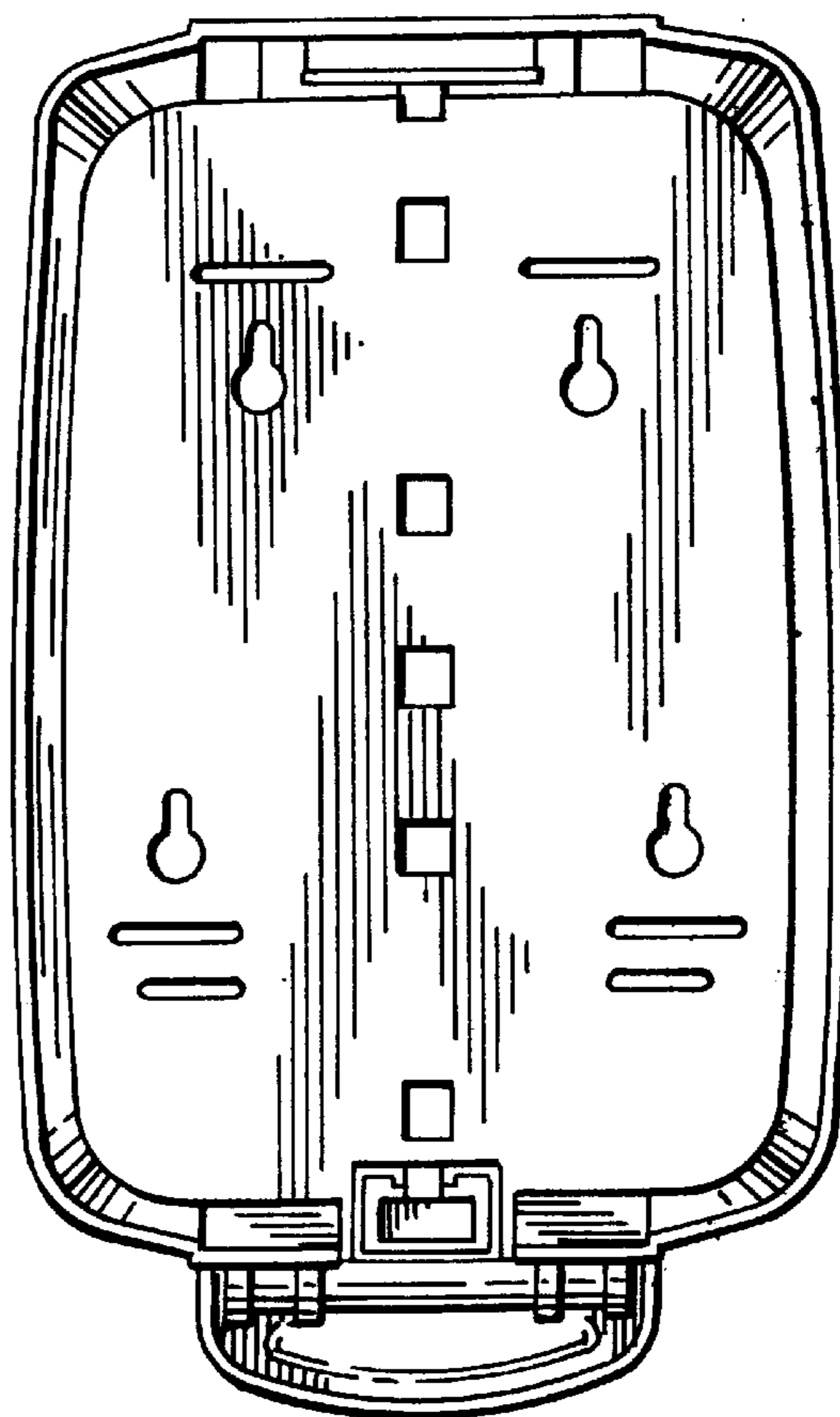

FIG. 4

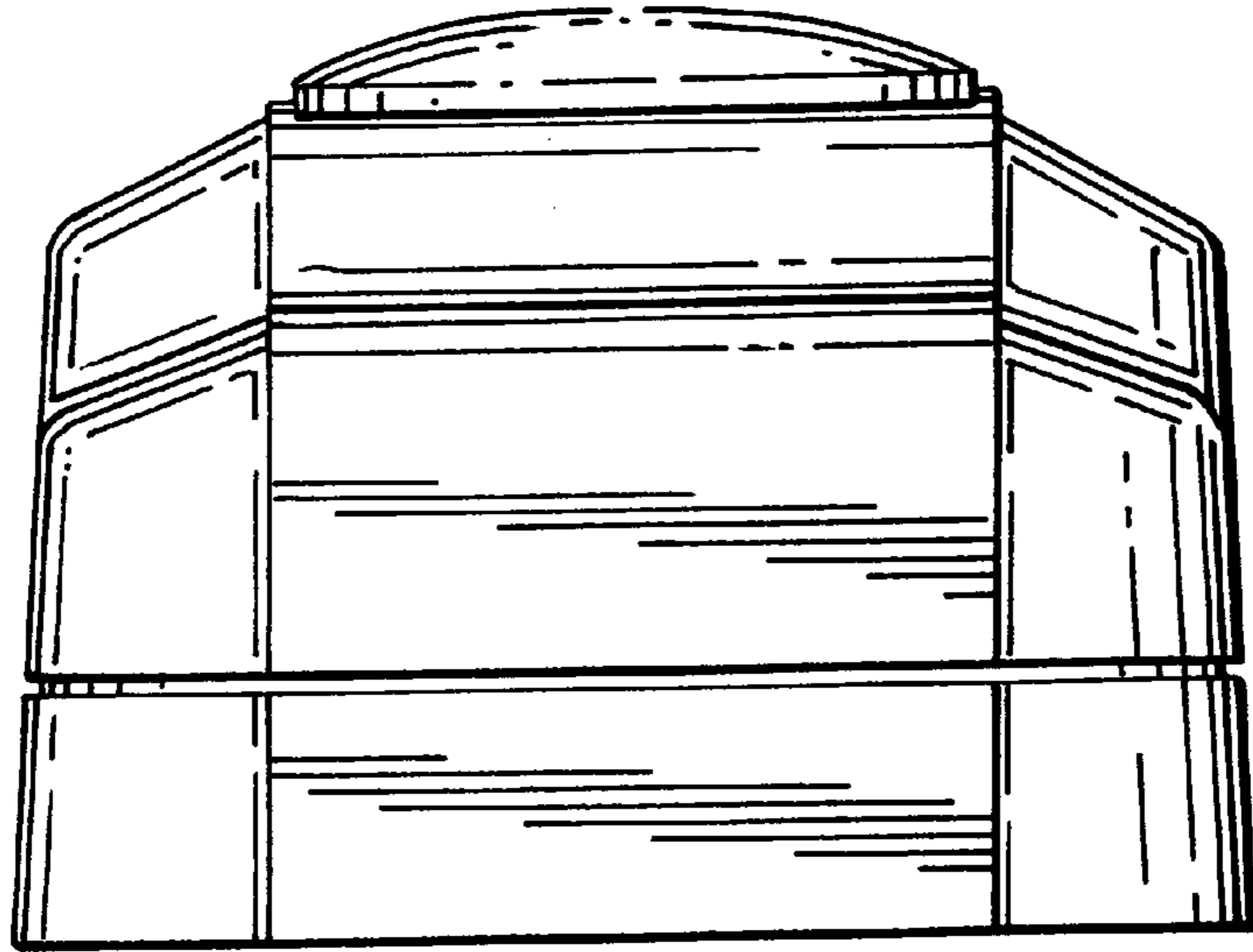

FIG. 5

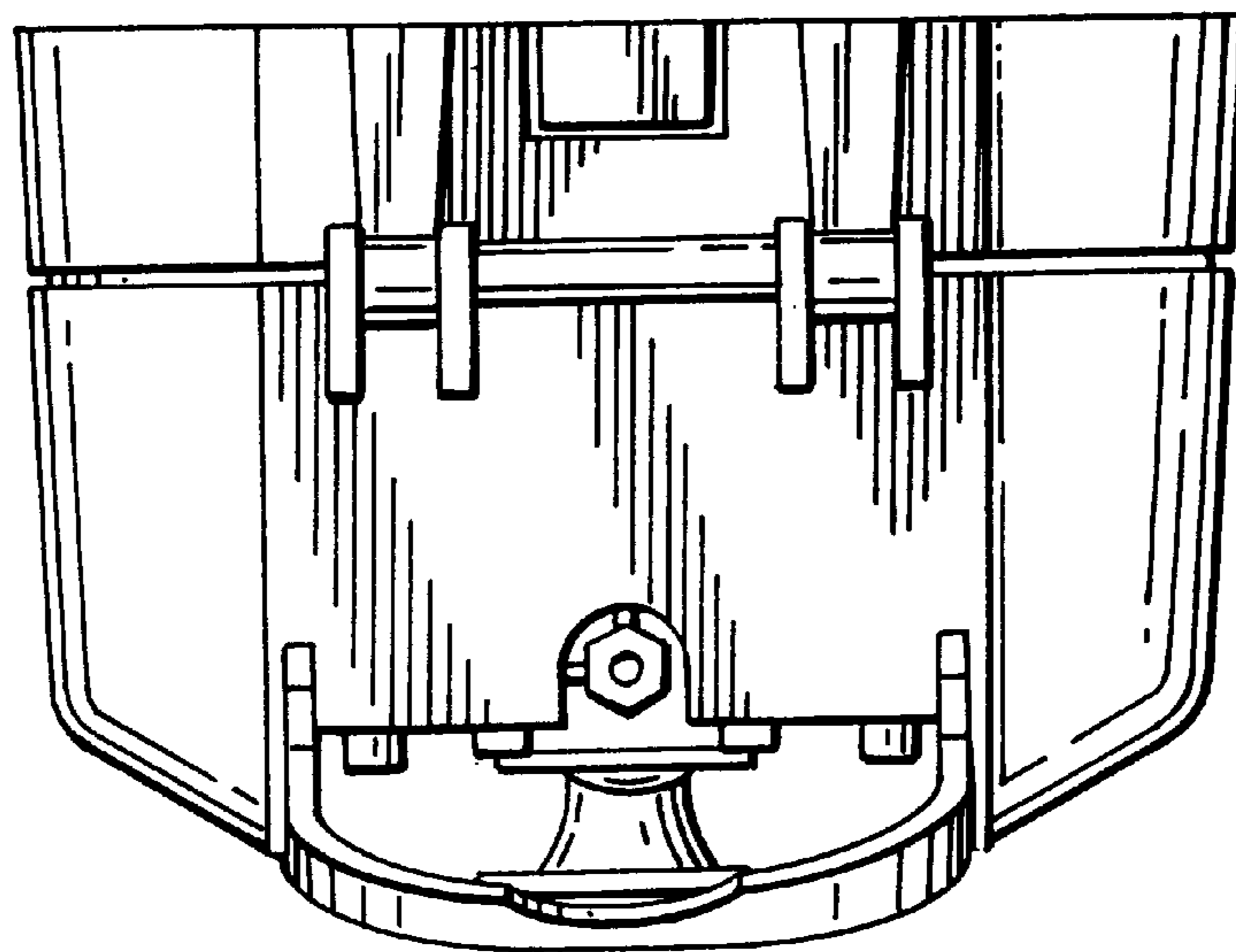

FIG. 6