



US00D431387S

United States Patent [19]

Natuzzi et al.

[11] Patent Number: Des. 431,387

[45] Date of Patent: ** Oct. 3, 2000

[54] SEAT

[75] Inventors: Pasquale Natuzzi, Bari; Cosimo Suma, Matera, both of Italy

[73] Assignee: Industrie Natuzzi, SpA, Bari, Italy

[**] Term: 14 Years

[21] Appl. No.: 29/110,562

[22] Filed: Sep. 9, 1999

[51] LOC (7) Cl. 06-01

[52] U.S. Cl. D6/381; D6/334

[58] Field of Search D6/334, 335, 336, D6/364, 371, 373, 381, 500, 501, 502; 5/12.1; 297/232, 445.1

[56] References Cited

U.S. PATENT DOCUMENTS

D. 382,130	8/1997	Natuzzi et al.	D6/381
D. 400,368	11/1998	Natuzzi et al.	D6/381
D. 407,573	4/1999	Natuzzi et al.	D6/381
D. 418,994	1/2000	Natuzzi et al.	D6/381
D. 419,328	1/2000	Natuzzi et al.	D6/381
D. 420,525	2/2000	Watson	D6/381
D. 421,193	2/2000	Natuzzi et al.	D6/381
D. 424,318	5/2000	Natuzzi et al.	D6/381
D. 424,319	5/2000	Natuzzi et al.	D6/381

OTHER PUBLICATIONS

- Natuzzi Model 417, Oct. 1987, at International Home Furnishings Market in High Point, North Carolina.
- Natuzzi Model 474, Nov. 1988, at International Home Furnishings Market in High Point, North Carolina.
- Natuzzi Model 667, Oct. 1991, at International Home Furnishings Market in High Point, North Carolina.
- Natuzzi Model 700, Oct. 1989, at International Home Furnishings Market in High Point, North Carolina.
- Natuzzi Model 717, Oct. 1989, at International Home Furnishings Market in High Point, North Carolina.
- Natuzzi Model 734, Apr. 1990, at International Home Furnishings Market in High Point, North Carolina.
- Natuzzi Model 763, Apr. 1990, at International home Furnishings Market in High Point, North Carolina.

- Natuzzi Model 789, Oct. 1990, at International Home Furnishings Market in High Point, North Carolina.
- Natuzzi Model 895, Apr. 1992, at International Home Furnishings Market in High Point, North Carolina.
- Natuzzi Model 899, Apr. 1992, at International Home Furnishings Market in High Point, North Carolina.
- Natuzzi Model 1045, Apr. 1993, at International Home Furnishings Market in High Point, North Carolina.
- Natuzzi Model 1077, Sep. 1993, at International Home Furnishings Market in High Point, North Carolina.
- Natuzzi Model 1125, Jan. 1994, at International Home Furnishings Market in High Point, North Carolina.
- Natuzzi Model 1367, Sep. 1995, at International Home Furnishings Market in High Point, North Carolina.

(List continued on next page.)

Primary Examiner—Gary D. Watson
Attorney, Agent, or Firm—Alston & Bird LLP

[57] CLAIM

The ornamental design for a seat, as shown and described.

DESCRIPTION

FIG. 1 is a front perspective view of a seat showing our new design in the form of a sofa;
 FIG. 2 is a front elevational view thereof;
 FIG. 3 is a top plan view thereof;
 FIG. 4 is a right side elevational view, the left side being a mirror image thereof;
 FIG. 5 is a rear perspective view thereof;
 FIG. 6 is a front elevational view of a seat showing our new design in the form of a loveseat; and,
 FIG. 7 is a front elevational view of a seat showing our new design in the form of a chair.

The broken lines shown herein are for illustrative purposes only and form no part of the claimed design.

The rear views of FIGS. 6 and 7 are like FIG. 5, the difference being a matter of length.

The end views of FIGS. 6 and 7 are like FIG. 4.

FIGS. 2, 3, 6 and 7 have been shown on a smaller scale with respect to FIG. 1 and FIGS. 4 and 5 have been shown on yet a smaller scale.

1 Claim, 3 Drawing Sheets

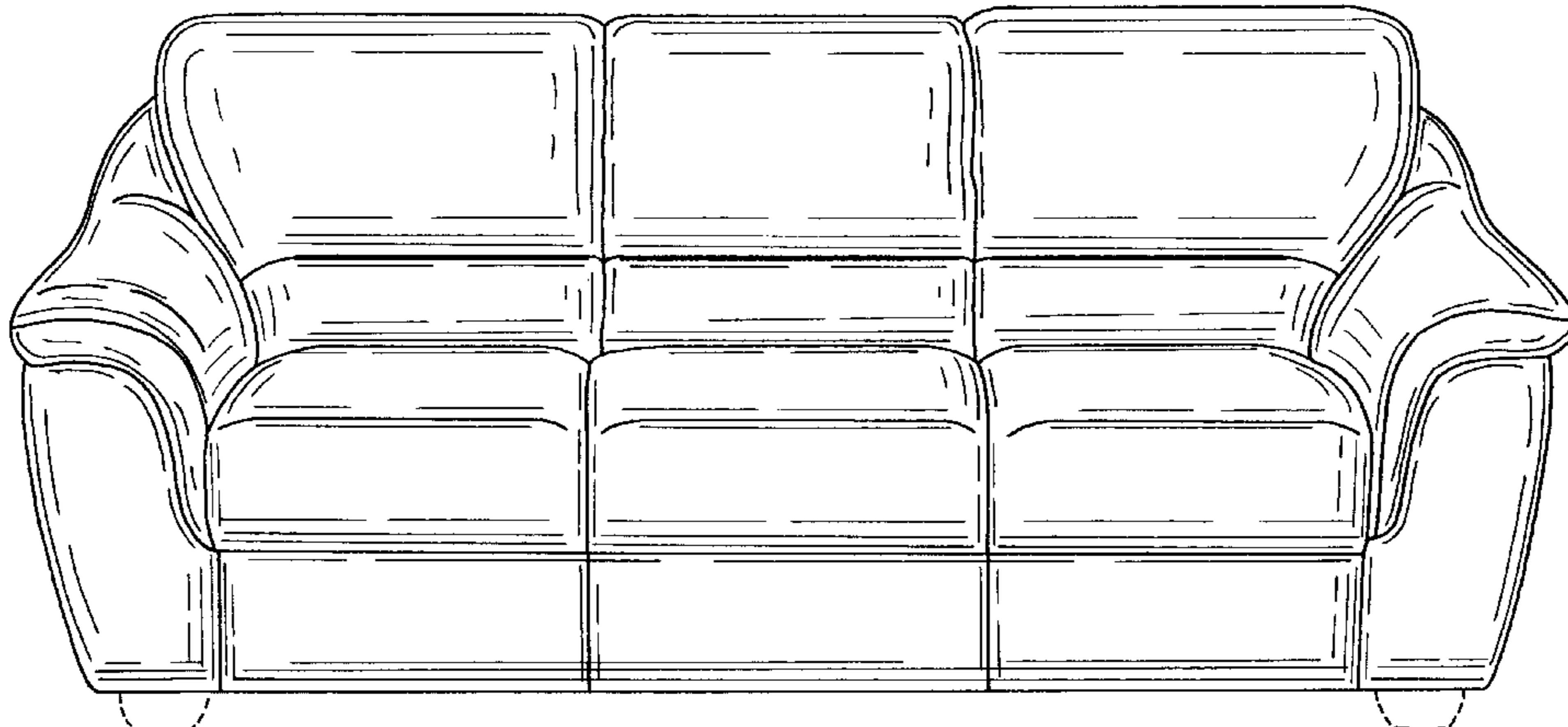

OTHER PUBLICATIONS

Natuzzi Model 1371, Oct. 1995, at International Home Furnishings Market in High Point, North Carolina.
Natuzzi Model 1401, Apr. 1996, at International Home Furnishings Market in High Point, North Carolina.
Natuzzi Model 1438, Mar. 1996, at International Home Furnishings Market in High Point, North Carolina.
Natuzzi Model 1448, Mar. 1996, at International Home Furnishings Market in High Point, North Carolina.
Natuzzi Model 1480, Oct. 1996, at International Home Furnishings Market in High Point, North Carolina.
Natuzzi Model 1483, Oct. 1996, at International Home Furnishings Market in High Point, North Carolina.
Natuzzi Model 1526, Oct. 1996, at International Home Furnishings Market in High Point, North Carolina.
Natuzzi Model 1563, Apr. 1997, at International Home Furnishings Market in High Point, North Carolina.

Natuzzi Model 1564, Apr. 1997, at International Home Furnishings Market in High Point, North Carolina.
Natuzzi Model 1572, Apr. 1997, at International Home Furnishings Market in High Point, North Carolina.
Natuzzi Model 1584, Apr. 1997, at International Home Furnishings Market in High Point, North Carolina.
Natuzzi Model 1597, Apr. 1997, at International Home Furnishings Market in High Point, North Carolina.
Natuzzi Model 1604, Apr. 1997, at International Home Furnishings Market in High Point, North Carolina.
Natuzzi Model 1630, Oct. 1997, at International Home Furnishings Market in High Point, North Carolina.
Natuzzi Model 1689, Apr. 1998, at International Home Furnishings Market in High Point, North Carolina.
Natuzzi Model 1702, Apr. 1998, at International Home Furnishings Market in High Point, North Carolina.

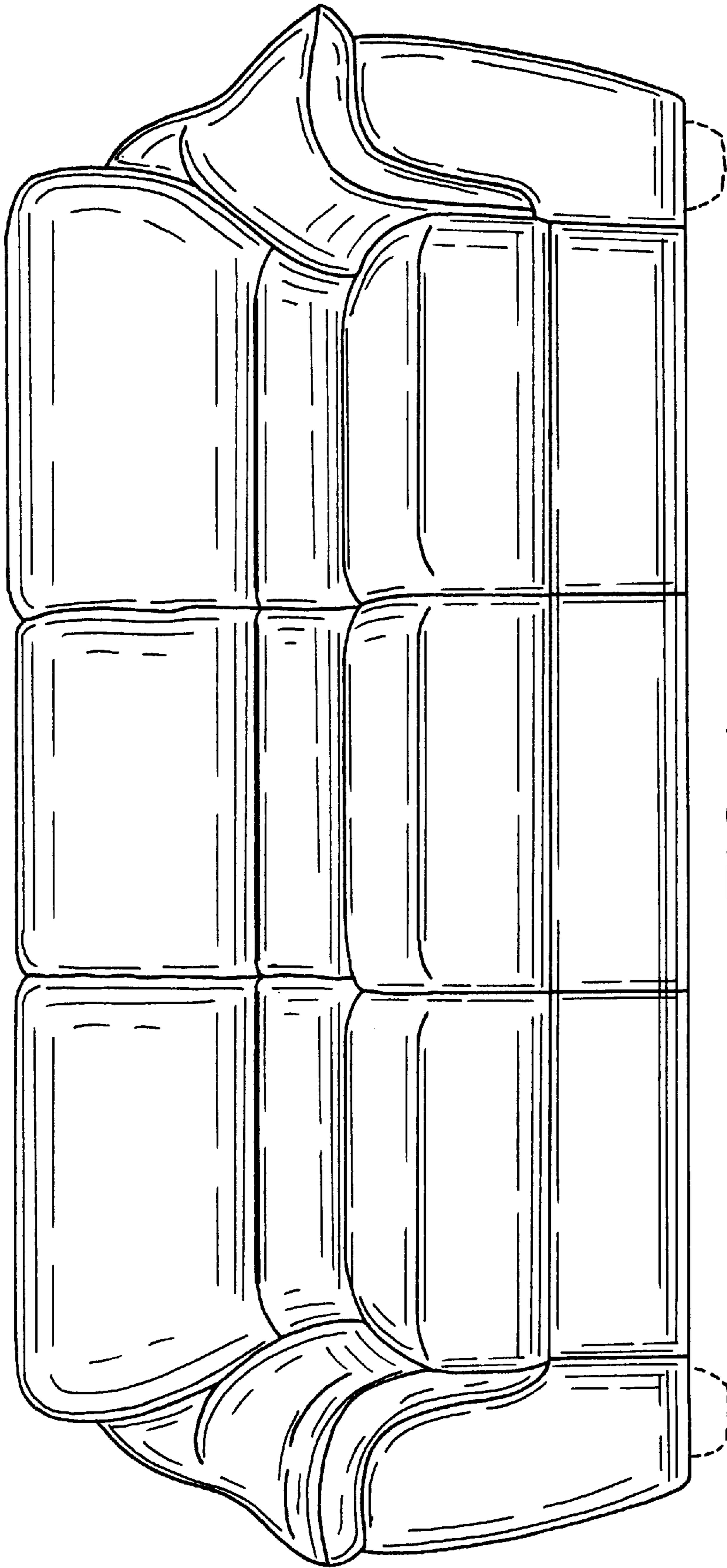

FIG. 1.

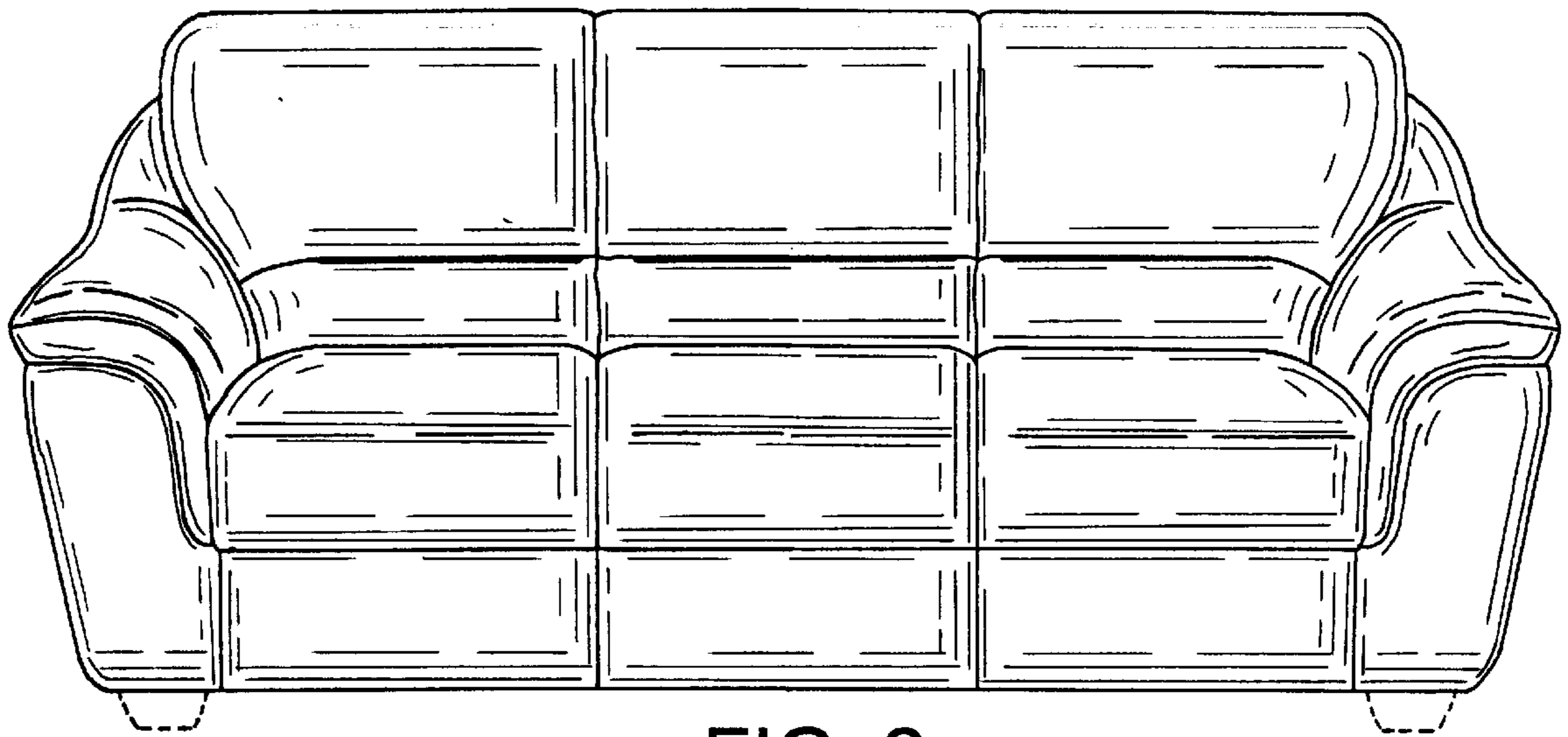

FIG. 2.



FIG. 3.

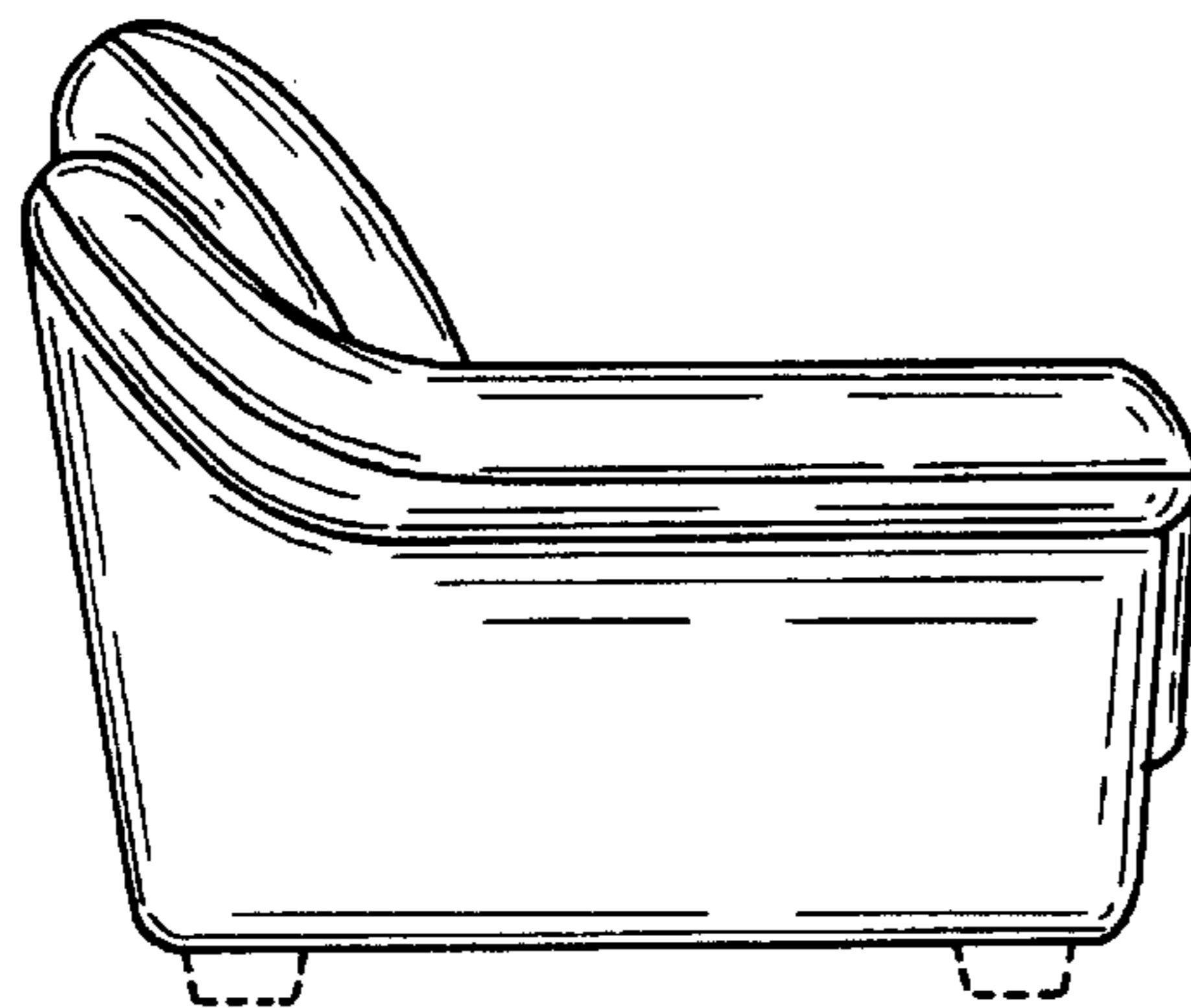

FIG. 4.

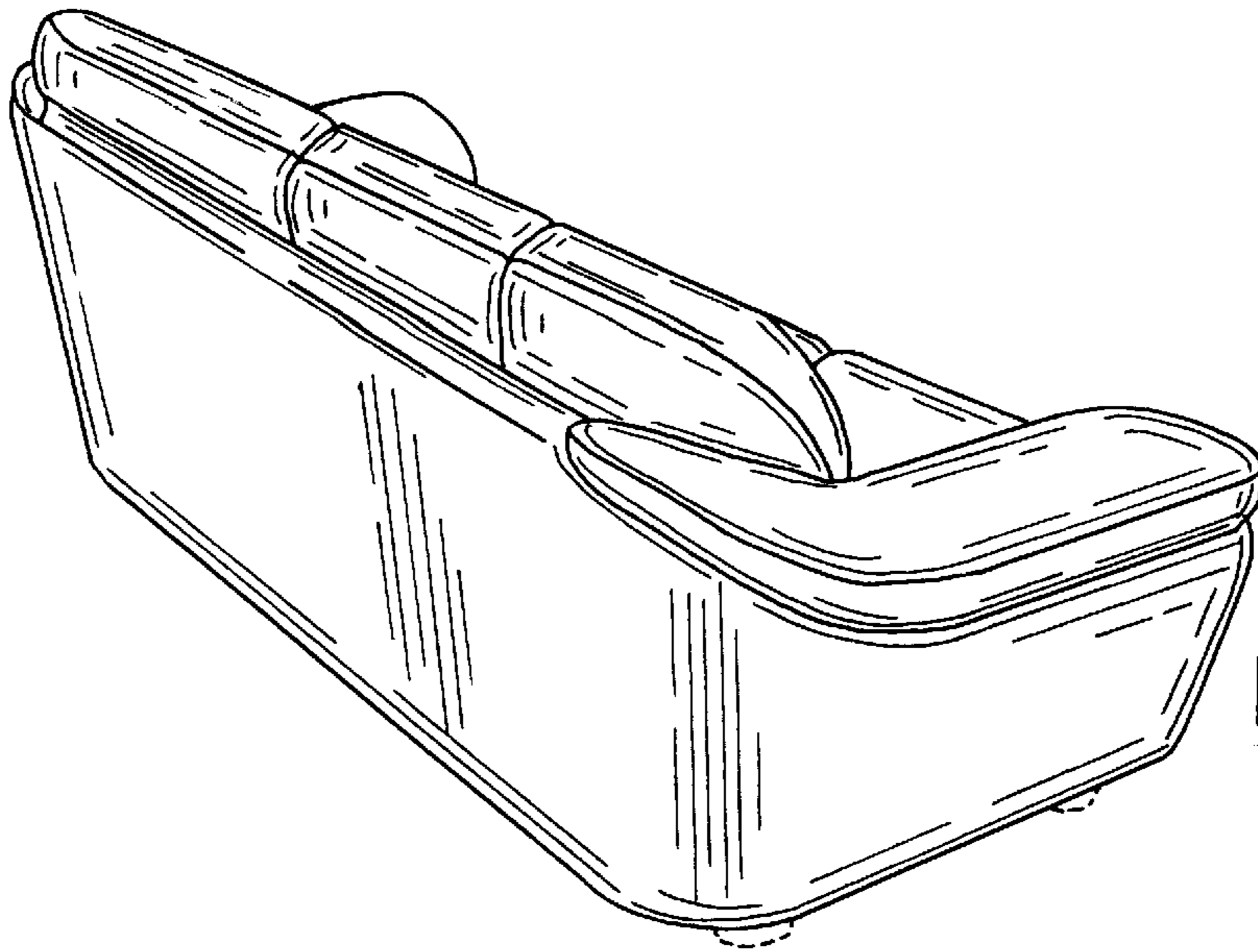

FIG. 5.

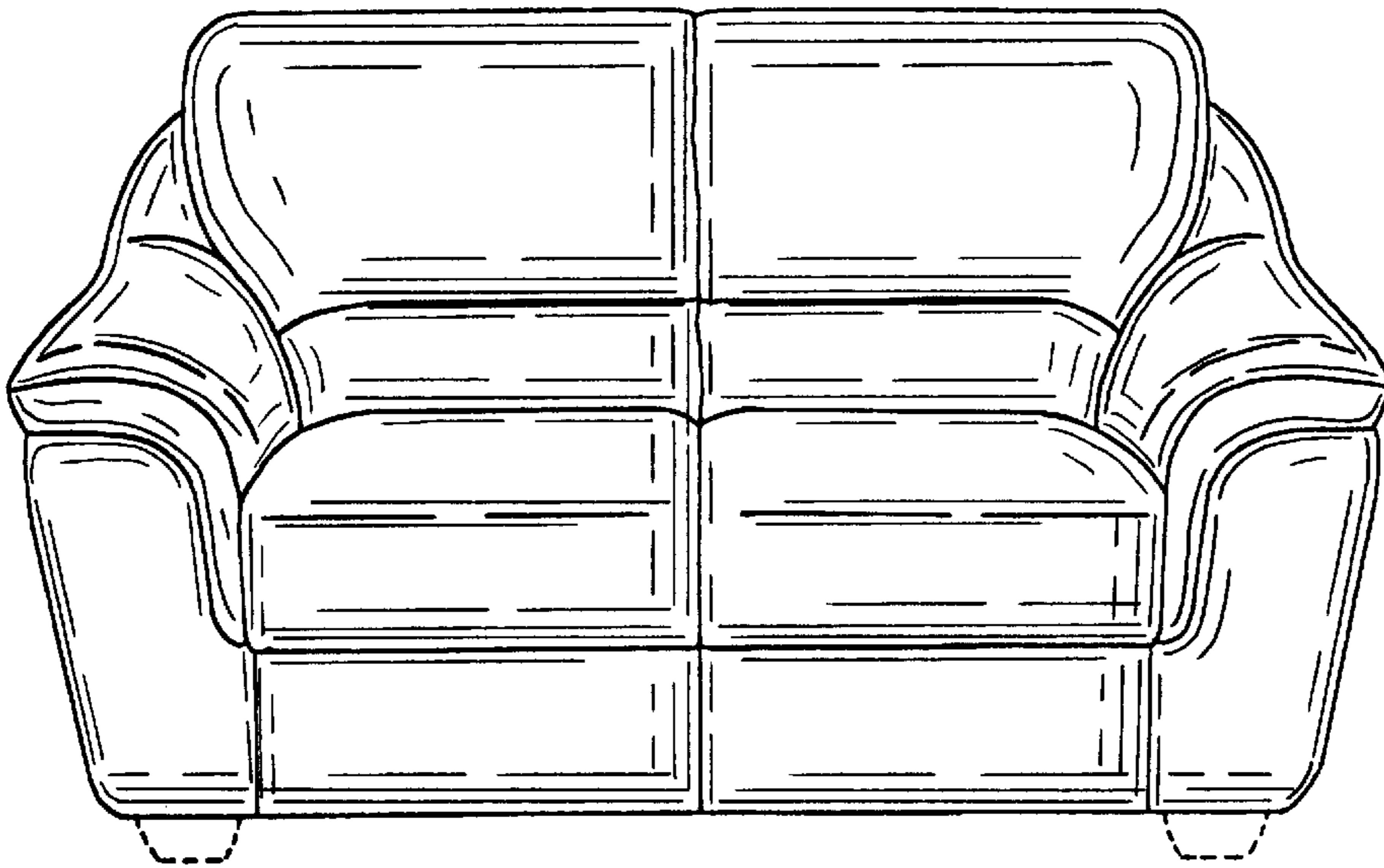

FIG. 6.

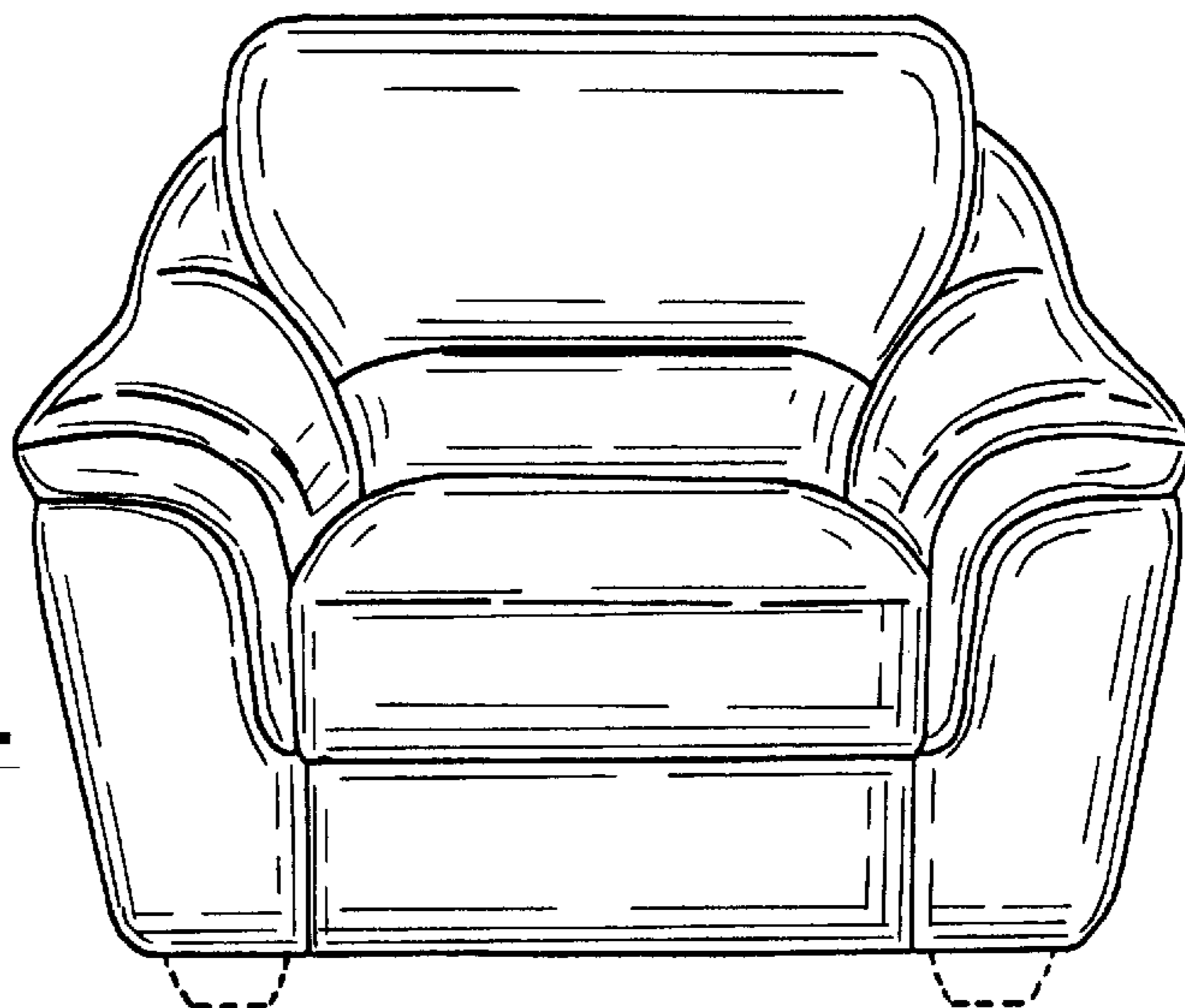

FIG. 7.